

PARTICULAR SPECIFICATION

APPENDIX B

SAFETY, HEALTH AND ENVIRONMENT

(June 2022 Edition)

The following table serves to highlight new or amended clauses made to this specification (June 2022 Edition) and are by no means exhaustive. Contractor shall read through and comply with all the safety, health and environmental requirements contained in this specification.

S/NO	Clause	Clause Heading
1	Clause 52	Total Workplace Safety and Health (Total WSH)
2	Attachment A-3	Risk Assessment Guidelines
3	Annex A-g 1.4, 1.5, 2.1, 2.4, 2.5, 2.6, 2.11, 2.13	Environmental Consideration
4	Attachment A-7	Carbon Assets Inventory Form
5	Attachment A-10	Waste Management Plan
6	Annex A-y	Construction Site Machinery Key Management Procedure

PARTICULAR SPECIFICATION**APPENDIX B****SAFETY, HEALTH AND ENVIRONMENT****CONTENTS**

<u>Clause</u>	<u>Title</u>	<u>Page PS-A-</u>
1.	Legal Requirements	1
2.	BCA's permit to carry out structural works	1
3.	SHE Management System (SHEMS)	1
4.	Responsibility	2
5.	SHE Enforcement	2
6.	Monthly SHE Report	2
7.	Safety, Health & Environmental (SHE) Personnel	2
8.	Workplace Safety and Health Coordinator	4
9.	Method Statement	5
10.	Permit to Work (PTW)	5
11.	SHE Training	5
12.	SHE Coordination Meeting	6
13.	SHE Committee	7
14.	Tool Box Meetings	8
15.	Engineer's Project Safety, Health and Environmental Committee	8
16.	Accidents & Incidents Reporting	8
17.	In-House SHE Rules and Regulations	9
18.	Personal Protective Equipment (PPE)	9
19.	SHE Promotion	10
20.	Evaluation, Selection and Control of Sub-Contractors	11
21.	SHE Inspection	12
22.	Maintenance Regimes For All Construction Plant, Equipment	13
23.	Hazardous Substances and Chemicals	13
24.	Hand protection programme	14
25.	Monthly Environmental, Safety and Security (ESS) Assessment	14
26.	Contractor Senior Management's Safety, Health and Environmental (SHE) Commitment Presentation	15
27.	Safety, Health and Environmental Audit	15
28.	Temporary Electrical Installations at the Site	16
29.	Storage License for Petroleum and Flammable Materials	16
30.	Welding and Cutting	17
31.	Emergency Preparedness	18
32.	Fire Safety Plan	19
33.	Work in Confined Spaces	20
34.	Illumination	21
35.	Welfare Provisions	21
36.	First Aid Provisions	22
37.	Ladders	22

PARTICULAR SPECIFICATION**APPENDIX B****SAFETY, HEALTH AND ENVIRONMENT****CONTENTS**

<u>Clause</u>	<u>Title</u>	<u>Page PS-A-</u>
38.	Scaffolds	23
39.	General Safety	23
40.	Safety (Anti-fall) Net	27
41.	Barricade / cover to voids, Trench, Bored holes and Open Edges of Structure	27
42.	5S Housekeeping method	27
43.	Behaviourial based safety (BBS)	28
44.	CCTV	28
45.	Traffic Control and Road Safety	29
46.	Usage of New Heavy Equipment in LTA Worksites	29
47.	Site Clearance Including Tree Felling and Transplanting Works	30
48.	SHE Sharing & Site Visits	30
49.	Working In Defined Areas	30
50.	Restricted usage of Handphone	30
51.	Mobilisation and Demobilisation of Machinery	31
52.	Total Workplace Safety and Health (Total WSH)	31
53.	Annexes	31

PARTICULAR SPECIFICATION**APPENDIX B****SAFETY, HEALTH AND ENVIRONMENT**

Attachment Title Page PS-A-

A-1a	Accident Occurrence Report Form	33
A-1b	Incident Occurrence Report Form	43
A-1c	Environmental Incident Occurrence Report Form	44
A-1d	Scheduled Charges for Fatality, Lost of Body Parts or Functions	49
A-2	Contractor's Monthly Safety, Health & Environment (SHE) Report	51
A-3	Risk Assessment Guidelines	83
A-4	Method Statement Submission Requirements	88
A-5	ESS Assessment Form on Contractors	90
A-6	Environmental Impact Register	164
A-7	Carbon Assets Inventory Form	165
A-8	Air Pollution Control Plan	168
A-9	Vector Control Plan	169
A-10	Waste Management Plan	174
A-11a	Noise Management Plan (for contract sum \geq \$20 million)	177
A-11b	Noise Management Plan (for contract sum $<$ \$20 million)	180
A-12	Earth Control Measures Plan	184
A-13	QECP Inspection Report Template	187
A-14	Flood Prevention Checklist	197
<u>Annex</u>	<u>Title</u>	<u>Page PS-A-</u>
A-a	Lifting Operations	99
A-b	Site Transport	110
A-c	Site Security	115
A-d	Civil Engineering / Deep Excavations	122
A-e	Temporary Housing Quarters	127
A-f	Approval Procedure for Usage of New Heavy Equipment in LTA Worksites	128

PARTICULAR SPECIFICATION**APPENDIX B****SAFETY, HEALTH AND ENVIRONMENT**

Attachment Title Page PS-A-

A-f1	Flow Chart on Use Of New Heavy Equipment In LTA Worksites	131
A-f2	Application for Use Of New Heavy Equipment	131
A-g	Environmental Considerations	133
A-h	Biodiversity	194
A-i	Flooding	195
A-j	Marine Works	200
A-k	Contaminated Ground	205
A-l	D&B Rail Projects Civil Design Safety Submissions	208
A-m	Build Only Rail Projects Civil Design Safety Submissions	224
A-n	D&B Road Projects Civil Design Safety Submissions	236
A-o	Build Only Road Projects Civil Design Safety Submissions	250
A-p	Protection of Slab Openings	262
A-q	Safe Installation and Maintenance of Sliding Gates (both permanent and temporary)	266
A-r	Photographs Highlighting Good SHE Practices	268
A-s	Mobile Elevated Working Platform (MEWP) Usage On Site	309
A-t	Electronic Safety, Health and Environmental Management System (e-SHEMS)	311
A-u	Designed For Safety (DfS) and Designed For Safety Professional (DfS Professional)	320
A-v	Safe Work Procedure for Controlling Movement of Heavy Machineries	322
A-w	Formwork Structures	325
A-x	Safe Management Measures	330
A-y	Construction Site Machinery Key Management Procedure	331

PARTICULAR SPECIFICATION

APPENDIX B

SAFETY, HEALTH AND ENVIRONMENT

1. LEGAL REQUIREMENTS

- 1.1. The Contractor shall comply with all applicable legislative safety, health and environmental (SHE) requirements of Singapore including any new acts and regulations which may be gazetted during the Contract period including any amendments or re-enactments thereto.
- 1.2. The Contractor shall comply with all the SHE requirements contained in this specification and supporting documentation, even where these impose a higher standard than that required by current Singapore legislation.

2. BCA'S PERMIT TO CARRY OUT STRUCTURAL WORKS

- 2.1 Upon award of the Contract, the Contractor shall register their works with the Building and Construction Authority (BCA) to obtain BCA's permit to carry out structural works as defined under the Building Control Act and its Regulations. A copy of the BCA's permit shall be submitted to the Engineer.
- 2.2 For worksites that do not need BCA's permit to carry out structural works, the Contractor shall submit a copy of the non-notifiable Workplace Number from MOM to the Engineer.

3. SHE MANAGEMENT SYSTEM (SHEMS)

- 3.1. Within 12 weeks of award of the Contract, the Contractor shall submit a SHEMS in accordance to "SS CP79, Code of Practice for Safety Management System for the construction worksites", and where applicable in compliance with ISO 14001 and ISO 45001 for his acceptance. The SHEMS shall incorporate all relevant legal and contractual requirements.
- 3.2. The Contractor shall implement a fully digital electronic SHE Management System application tools (e-SHEMS) that complies with Annex A-t for the worksite. The e-SHEMS shall be able to operate on mobile devices and perform data analysis to identify SHE trend and gaps. Contractor shall ensure the e-SHEMS is tamper-proof to protect authenticity of records and equipped with strong data security measures.

4. RESPONSIBILITY

- 4.1. The Contractor shall be responsible for the SHE of all operations in connection with the Contract and shall take all necessary actions to ensure the safety of all persons who may be on or adjacent to the Site.
- 4.2. The Contractor shall be responsible for ensuring that his sub-contractors; interfacing contractors; and all persons entitled to be on the Site comply with all relevant legal and contractual requirements including the Contractor's SHEMS and shall enforce its compliance.
- 4.3. If the Contractor is working within the Site (factory) of an interfacing contractor, the Contractor shall comply with the interfacing contractor's SHEMS.

5. SHE ENFORCEMENT

- 5.1. The Engineer may require the removal from the Site of any person who fails to observe SHE procedures and that person shall not be again deployed on any of the Authority's projects without the written approval of the Engineer.

6. MONTHLY SHE REPORT

- 6.1. The Contractor shall prepare a monthly SHE report in the format stated in Attachment A-2. The SHE report shall be in electronic copy (e-copy) format and submit to the Engineer within 5 days after the month completion.

7. SAFETY, HEALTH & ENVIRONMENTAL (SHE) PERSONNEL

- 7.1. SHE personnel refer to Workplace Safety and Health Officer (WSHO) registered with the Ministry of Manpower (MOM) and Environmental Control Officer (ECO) registered with the National Environment Agency (NEA).
- 7.2. All SHE personnel in clause 7.1 shall have at least three (3) years post registration and practical experience relevant to the scope of works of the Contract.

The Engineer may accept the appointment of the 2nd WSHO and ECO who does not meet the three (3) years post registration and practical experience on a probational basis if Contractor is able to justify the proposed candidate has the capability to perform the role and Contractor has a mentorship programme lead by his corporate WSH Manager to support and guide the candidate.

- 7.3. Prior to his appointment, the Contractor shall submit the SHE personnel's resume with detailed listing of his past experiences for the Engineer's approval. WSHO shall preferably has a locally recognised Diploma/Degree in engineering discipline. Upon the Engineer's approval, application for the appointment shall be made to MOM or NEA and submitted to the Engineer.
- 7.4. The Engineer shall require the replacement of the appointed SHE personnel if the performance of the SHE personnel is not up to the Engineer's expectation.
- 7.5. All SHE personnel shall be identified clearly on site with a blue coloured safety helmet.
- 7.6. The SHE personnel to be appointed on site shall comply with the value stated in the table below:

Contract Value	Full time SHE Personnel
Above S\$1 million to S\$20 million	1 WSHO cum ECO
Above S\$20 million to S\$50 million	1 WSHO & 1 ECO
Above S\$50 million	2 WSHO & 1 ECO

Note: Contract Value for SWC refers to "Value of works carried out in Singapore". "Value of works" refers to installation, delivery, testing, commissioning and other physical works carried out in Singapore.

- 7.7. Notwithstanding clause 7.6, if deemed necessary by the Engineer, the Contractor shall appoint additional SHE personnel to ensure adequate SHE cover for all Contract related works. In such events, the Contractor shall not be entitled to any claim for compensation
- 7.8. The Contractor shall appoint the WSHO and ECO within one (1) month upon award of contract and subsequent WSHO no later than three (3) months thereafter.
- 7.9. The Contractor shall provide cover for WSHO and/or ECO during their periods of absence due to annual leave, sick leave, National Service and training etc.

- 7.10. Notwithstanding clause 7.6, Contractor with more than one (1) contract with the Authority shall appoint a full-time corporate Workplace Safety, Health and Environmental (WSHE) Manager to take charge in ensuring the various contracts achieve and meet the performance standards required by the Engineer. The WSHE Manager shall have (i) at least ten (10) years post registration (with the Ministry of Manpower) practical experience relevant to the scope of works of the Contract, including experience in overseeing environmental management on site. The WSHE Manager shall also be a registered ECO with NEA. The WSHE Manager shall be employed exclusively for LTA contract(s), based full time on site and be stationed at a location as specified by the Engineer, and be required to perform his duties until the last Contract achieves its Completion of Whole of Works (CWW).
- 7.11. For Contract with Contract sum above S\$50 million Contractor may, with the approval of the Engineer, redeploy one (1) of the WSHO when the Contract received Temporary Occupant Permit (TOP) from Building Construction Authority (BCA). This would be subject to the Contractor's Safety performance.

8. WORKPLACE SAFETY & HEALTH COORDINATOR

- 8.1. The Contractor shall appoint a minimum of one full time Workplace Safety & Health Coordinator for every S\$10 million or part thereof the Contract Sum subjected to a maximum of four (4) Workplace Safety & Health Coordinators per contract to ensure effective safety supervision on site during all working hours. Notwithstanding, if deemed necessary by the Engineer, the Contractor shall appoint additional Workplace Safety & Health Coordinators to ensure adequate cover for all Contract related works. This may include operating a shift system. Provision shall be made for providing cover at weekends and during periods of absence from site in excess of one day for annual leave, sick leave, National Service training and similar. In such events, the Contractor shall not be entitled to any claim for compensation
- 8.2. The Workplace Safety & Health Coordinator shall have at least two (2) years of relevant experience after obtaining his certificate.
- 8.3. In addition, every sub-contractor to the Contractor shall appoint a full time Workplace Safety & Health Coordinator and every sub-sub-contractor who employs more than 20 persons to carry out work at the Site shall appoint a part-time Workplace Safety & Health Coordinator. These part time Workplace Safety & Health Coordinators shall spend at least 15 hours per week exclusively on safety supervision.

9. METHOD STATEMENT

- 9.1. The Contractor shall identify all safety critical activities and ensure that a method statement is prepared for each activity and accepted by the Engineer before commencement of such activities. The method statement submission requirement is provided in Attachment A-4. Risk Assessments conforming to the risk assessment guidelines provided in Attachment A-3 shall be submitted with all method statements.
- 9.2. The Contractor shall address all comments on the method statement arising from the Engineer's review. The Contractor shall fully comply with the method statement approved by the Engineer. If there is any intention to change the method of work, the Contractor shall seek approval from the Engineer.

10. PERMIT TO WORK (PTW)

- 10.1. The Contractor shall implement a PTW system as required by Singapore legislations or by the Authority.
- 10.2. The PTW shall be valid only for the day or shift unless otherwise agreed upon by the Engineer.
- 10.3. The safety assessor and the occupier's project manager approving the PTW shall be separate persons. In addition, the safety assessor shall be appointed from Contractor's own supervisory staff.

11. SHE TRAINING

- 11.1. To ensure the whole supervision team have a clear understanding and consistent application of SHE requirements, the Contractor shall ensure his site management team, site supervisors, Safety and Health co-ordinators and WSHOs attend the Construction Safety Management Course at LTA Academy within six (6) months from the award of contract.
- 11.2. The Contractor shall provide a training room capable of providing training to at least 20 workers at a time. The training room shall be provided with all the necessary audio and visual training facilities.
- 11.3. SHE training shall include experiential learning which includes experiencing the simulation of the construction risks/hazards such as (but not limited to):
- (a) Fall from height
 - (b) Work at height
 - (c) Struck by falling object
 - (d) Pinned or hit by a heavy machinery

- (e) Lifting operation / safe rigging
- (f) Scaffold / Falsework
- (g) Confined Space
- (h) Electrical system
- (i) Manual handling
- (j) Hand injuries
- (k) Traffic / pedestrian safety
- (l) Trench and utility protection
- (m) Emergency preparedness
- (n) First aid

- 11.4. Where such safety training as mentioned in clause 11.3 is not available on site, the Contractor shall source for a suitable off-site training centre that provides such training and to send his workers, sub-contractors and other site personnel to attend training there. The Contractor shall keep records of these trainings for audit.
- 11.5. The Contractor shall ensure that no personnel including interfacing contractors commence work on site before the completion of the Contractor's in-house safety induction training and the issuance of a security pass. The Contractor shall ensure that training information is given in languages understood by the trainees. In addition, the Contractor shall have a system to clearly identify new employees and workers for their initial 30 days on site.
- 11.6. The Contractor shall employ qualified operators for all machineries to be used on Site even if it is not required by legislation. The operators shall possess a Skills Evaluation Certificate (SEC) from the Building and Construction Authority (BCA) Academy or other approved training centre. For machineries where there is no skilled training available in Singapore, the Contractor shall engage the supplier of the machinery to train them and authorise them in writing. Examples of qualified operator include, but not limited to gantry crane operator, excavator operator, boring / piling Operator and welder.
- 11.7. The Contractor shall ensure that all his supervisory staff (including engineer, supervisor, charge-hand, foreman, kapala and team leader) attained the "Supervise Construction Work in WSH" Certificate or such WSH certificates accepted by the Engineer.
- 11.8. The Contractor shall develop and implement a comprehensive assessment system to ensure the competency of his supervisory staff, lifting team and machine operators prior to their deployment for works. The assessment system shall include face-to-face interviews and written tests that adequately evaluate their appreciation of safety hazards associated with respective works, Safe Work Practices (SWP) etc.

- 11.9. The Contractor shall ensure that all personnel and in particular new personnel, or personnel transferred to new assignments are given proper safety training relevant to their duties.
- 11.10. The Contractor shall implement an identification system on site to clearly identify all the qualified personnel and operators.

12. SHE COORDINATION MEETING

- 12.1. The Contractor shall conduct weekly SHE co-ordination meetings with his sub-contractors and interfacing contractors to ensure that works are carried out on Site with minimum risk to workers and to the public. The meeting shall plan and co-ordinate all works on site including the handover readiness of rooms and areas within Site, the movement of plant, equipment and hazardous materials and also review SWP, PTW procedures, training, PPE, safety equipment and discussion of incidents, if any. The meeting shall also inform personnel of potentially dangerous work at the Site.
- 12.2. During coordination meetings on Combined Services Drawings (CSD), Structural, Electrical and Mechanical (SEM) and Coordinated Installation Programme (CIP), the following items shall be included in the meeting agenda:
- a) Planning and sequencing of work activities and identification of incompatible works between contractors working in the same area;
 - b) Identification of risks and hazards pertaining to these interfacing works, including conducting site walks to verify these hazards;
 - c) Highlighting potential high risk zones during handing over; and
 - d) Developing a site map to show delivery routes and designated storage area for the Contractor and interfacing contractors.

13. SHE COMMITTEE

- 13.1. The Contractor shall establish a SHE Committee regardless of the number of workers. The Committee shall comprise of management and safety representatives from the Contractor, his sub-contractors including any interfacing contractors and workers' representatives. The Engineer's staff shall be invited to sit in the Committee on an ex-officio basis.
- 13.2. The Committee shall inspect the Site at least one week before each month's meeting.

- 13.3. The Contractor shall adopt the following format for his SHE Committee Meeting.
- a) Confirmation of Minutes;
 - b) Matters arising;
 - c) Chairman's review of SHE performance / condition;
 - d) Report from the Secretary;
 - e) Report from SHE Representatives;
 - f) SHE Inspection Report;
 - g) Near Miss reporting, accidents and incidents;
 - h) Reports on status of authorities' visits, and discuss follow up actions;
 - i) SHE talk by Committee Members;
 - j) Report from the Engineer; and
 - k) Any other business.

- 13.4. The Contractor shall ensure that all major decisions and actions made at each meeting are effectively communicated for implementation.

14. TOOL BOX MEETINGS

- 14.1. Tool Box Meetings shall be conducted daily before work commence, and it should be specific to the work performed for the day. Workers shall be briefed on the day's activities, the SHE precautions to be observed, the SWP to be followed, and personnel's PPE shall be checked to ensure its suitability, and its correct use be explained where necessary.

15. ENGINEER'S PROJECT SAFETY, HEALTH AND ENVIRONMENTAL (SHE) COMMITTEE

- 15.1. The Engineer may require the Contractor's Project Manager and SHE personnel to attend the Engineer's Project SHE Committee meeting to review their SHE provisions on site.

16. NEAR MISS, ACCIDENTS & INCIDENTS REPORTING

- 16.1. Notwithstanding the reporting requirements of the legislation and the Insurance Specification, the Contractor shall notify the Engineer of any accident, incident, Dangerous Occurrence or near miss associated with the Contract. Verbal notification to the Engineer shall be done immediately and followed up by written notification within 24 hours in the format shown in Attachment A-1a, 1b and 1c.

- 16.2. In addition to clause 16.1, failure to provide immediate notification to the Engineer shall warrant deduction in the monthly ESS assessment.

The deduction shall be based on the number of late notifications accumulated throughout the Contract period as follows:

- a) 5 marks for the 1st case,
- b) 10 marks for the 2nd case,
- c) 20 marks for 3rd and subsequent cases.

- 16.3. The Contractor shall propose remedial measures to prevent recurrence of the near miss, incident and accident to the satisfaction of the Engineer.

- 16.4. The Contractor shall submit photos, sketches and evidences related to the near miss, incident or accident in soft and hard copies as deemed necessary to the satisfaction of the Engineer.

- 16.5. Accident that resulted in severing/amputation of body parts and / or impairment of function shall be reported to MOM as reportable accident. Regardless of the number of days of medical leave granted by a registered medical practitioner, the actual man-days lost shall be determined using the Scheduled Charges shown in Attachment A-1d.

17. IN-HOUSE SHE RULES AND REGULATIONS

- 17.1. The Contractor shall establish a set of in-house SHE rules and regulations based on industry standards and legislation for the Engineer's acceptance. The Contractor shall display sufficient copies of these rules and regulations on Site, translated into languages understood by the workers.

18. PERSONAL PROTECTIVE EQUIPMENT (PPE)

- 18.1. The Contractor shall provide, maintain and enforce the usage of PPE for all the personnel on site at all times. The following PPE shall be compulsory on site:
- a) Safety helmets with chin strap conforming to SS98 showing the contract number;
 - b) Safety footwear with steel toe cap and steel sole plate conforming to SS513;
 - c) High-visibility vest/clothing conforming to EN ISO 20471;
 - d) Cut-resistance gloves in accordance with EN388 and EN420;
 - e) Safety belts shall be provided for restraining falls or safety harness for fall protection. Safety belts and harness shall comply with SS528 series (Personal fall-arrest systems), SS541 (Restraint belts) and SS570 (Personal Protective Equipment for protection against falls from a height – Single point anchor devices and flexible horizontal lifeline systems).

f) Respirators / dust masks of the appropriate standard shall be provided for activities generating dust or fume.

18.2. The Contractor shall maintain and update a register of all PPE issued and present it to the Engineer for inspection when instructed.

19. SHE PROMOTION

19.1. The Contractor shall develop an annual SHE promotional programme to advance their SHE culture on Site and reinforce the concept that SHE and construction are inseparable. The programme shall enhance personal SHE awareness and influence attitudes and behaviour of all personnel on SHE matters. The programme shall consist of general promotional activities which are carried out as part of a day-to-day activity and high impact promotion activities which are carried out as a campaign to reinforce a particular SHE point at the Site. The SHE promotional programme shall be revised and updated at least once a year.

19.2. The Contractor shall organise a minimum of two (2) campaigns covering SHE related topics for each calendar year.

19.3. In addition to clause 19.2, the Contractor shall conduct regular 'Safety Time-out' sessions especially after any serious accident at LTA's projects or when a work activity has reached its 30%, 60% and 90% completion mark. This is to allow Contractor to take stock and refocus on safety, review current work activities and its associated hazards, as well as to identify additional safety measures required to maintain high WSH standards on the Sites. The Contractor may conduct the 'Safety Time-out' sessions on a site-wide basis or to focus on specific work activities or subcontractors at different stages of their Works. The Contractor shall submit a schedule and programme for the 'Safety Time-out' to the Engineer for approval.

19.4. The Contractor shall divide the worksites into designated work areas, each lead by his engineers or competent supervisors (including charge-hand / foreman / kapala / team-leader) who will be responsible for the area's SHE performance. The SHE performance for each work area shall be assessed monthly and corrective actions shall be taken to raise the area's safety performance. The monthly SHE assessment shall include, but not limited to accident statistics and substandard practices and conditions recorded at various SHE inspections for the particular work area. The teams that meet SHE targets shall be duly recognised and rewarded. The recognitions shall include both monetary and non-monetary rewards and to be given out at a suitable event attended by the workforce or as directed by the Engineer.

- 19.5. The Contractor shall provide, erect, maintain and finally remove when ordered, an Accident Statistics Board (ASB) 3m x 2m in size written boldly in English, the content of which shall include, but not limited to the following Date, Total man hours Worked; Total lost-time Accidents; Total fatalities; Total crane collapses; Frequency Rate; and Severity Rate.
- 19.6. The ASB shall be erected in a prominent location, preferably near the main entrance to the Site, which shall be to the acceptance of the Engineer. The Contractor shall be responsible for ensuring that the statistics are updated daily to reflect the status of the SHE performance at the Site.
- 19.7. The Contractor shall produce at least two SHE digital videos (“the SHE Video”) per year to raise the SHE awareness and standards of its workforce. The Contractor shall include at the start of each SHE videos the following phrase: “This video and all rights therein are the absolute property of the Land Transport Authority of Singapore (“LTA”). No person may reproduce, edit, quote, circulate, share or otherwise deal with this video without LTA’s express written permission”.
- 19.8. All Intellectual Property or IP in the SHE videos shall vest in and be the absolute property of the Authority and the Contractor shall not disclose, release or sell to any persons or otherwise deal with the same in any manner whatsoever without the Authority’s written consent. “Intellectual Property” or “IP” means all intellectual property rights, including copyrights, patent rights, registered designs and other similar proprietary rights of whatever nature.
- 19.9. The Contractor shall do all things necessary to ensure that all IP in the SHE videos are fully vested in the Authority in accordance with Clause 19.8 above. The Contractor further warrants that it shall have the authority to transfer or assign such IP to or otherwise vest such IP in the Authority when called upon by the Authority to do so.

20. EVALUATION, SELECTION AND CONTROL OF SUB-CONTRACTORS

- 20.1. The Contractor shall include legislative and Authority’s site specific SHE requirements in tender packages for their sub-contractor selection and conduct pre-job meetings to address job SHE expectation before awarding them.
- 20.2. The Contractor shall select sub-contractors who have attained bizSAFE level 4 certification, awarded by the Workplace Safety & Health Council, prior to their work commencement at site. Should there be sub-contractors who are not bizSAFE-certified, the Contractor shall ensure that such sub-contractors be certified to bizSAFE level 4 within a six (6)-month period, upon informing LTA of its intention to engage them. Notwithstanding this, the onus is on the Contractor to have all of its sub-contractors to be bizSAFE level 4 certified as early as possible.

20.3. The Engineer may participate in pre-tender meetings, selection process, pre-job meeting and review their SHE performances etc.

20.4. The Contractor shall conduct a monthly appraisal of his sub-contractors' Safety, Health and Environmental (SHE) performance using assessment criteria approved by the Engineer. The monthly sub-contractors' SHE performance shall be submitted to the Engineer. The Contractor shall implement suitable programs to raise the SHE performance standards of his non-performing sub-contractors.

21. SHE INSPECTION

21.1. The Contractor shall carry out internal SHE inspections at least once a day or at least once per shift. In addition, targeted spot checks should be carried out more frequently on critical site activities.

21.2. A written record shall be kept of the daily inspection findings and the results of inspections should be brought to the line manager having responsibility in the area concerned, together with the necessary remedial action and due date for completion. Any corrective action shall be immediately implemented by the line manager and followed up by the SHE personnel. The Contractor shall submit e-records of inspection report as deemed necessary by the Engineer.

21.3. Inspection of shoring of formwork, side supports of excavations and trenches, cranes and scaffolds should be carried out after every inclement weather, as the stability / integrity of these works may be affected.

21.4. The Contractor's senior site management shall participate in the Engineer's weekly, monthly, quarterly or any ad-hoc safety inspections and shall put up reports to record the inspection findings if so requested. The Contractor shall close out all inspection findings to the full satisfaction of the Engineer.

21.5. The Engineer shall require the Contractor to suspend a part of the Works or the whole of the Works if it is deemed to be unsafe. The Contractor shall be required to rectify the substandard condition or practice to the full satisfaction of the Engineer. In such events, the Contractor shall not be entitled to any claim for compensation or extension of time for completion.

21.6. The Environmental Control Officer (ECO) shall carry out weekly inspections and submit findings and remedial actions with photographs to the Engineer fortnightly.

22. MAINTENANCE REGIMES FOR ALL CONSTRUCTION PLANT, EQUIPMENT AND TOOLS

- 22.1. The Contractor shall assess the SHE risks especially in terms of age, noise, emissions, and condition etc. associated with the plant, equipment or tool and only those assessed with minimal SHE risks shall be brought to the Site.
- 22.2. The Engineer shall stop the plant, equipment or tool from operation or require its removal if he finds that the SHE associated risks to be high. The Contractor shall not be entitled to any claim for compensation or extension of time for completion.
- 22.3. The Contractor shall implement a preventive maintenance programme to ensure that all plant, equipment and tools are regularly maintained in a safe and working order.
- 22.4. The Contractor shall implement a monthly inspection program to inspect all plant, equipment and tools. All plants, equipment and tools that have undergone repair or maintenance shall be inspected and checked before being returned to service. Stickers or tags shall be displayed to indicate its approval for usage, otherwise it shall be indicated as “Not for Use”.
- 22.5. The Contractor shall ensure only original or manufacturer approved part is to be fitted on the plant, equipment and tools used on site. Any modification or substitution of part on the plant, equipment and tools shall be approved by the manufacturer.
- 22.6. The Contractor shall implement a lockout and tag-out system in accordance with SS571, Code of practice for Energy Lockout and Tagout procedures.
- 22.7. Job-made or modified tools of any kind shall not be used on site.
- 22.8. Key access to machinery/ equipment operations shall comply with Annex A-y Construction Site Machinery Key Management Procedure.

23. HAZARDOUS SUBSTANCES AND CHEMICALS

- 23.1. The Contractor shall assess the Safety Data Sheets (SDS) of all the hazardous substances and chemicals prior to its entry to site for its suitability in terms of SHE hazards and consider safer alternatives.
- 23.2. The Engineer may require the removal of any hazardous substance or chemical if there are safer alternatives. In such events, the Contractor shall not be entitled to any claim for compensation or extension of time for completion.

23.3. The Contractor shall ensure that all hazardous substance and chemical containers are labelled, their movements recorded and returned to the designated storage areas when not in use.

24. HAND PROTECTION PROGRAMME

24.1. The Contractor shall implement a hand protection programme subjected to the acceptance of the Engineer. The programme will:

- a) Identify activities on site that can cause hand injuries;
- b) Propose safety interventions such as engineering or administrative measures to reduce the hazards;
- c) Select, provide and maintain suitable hand protection devices and supervise their use; and
- d) Review and monitor the programme to test its effectiveness.

24.2. In addition to clause 24.1, where hand gloves are used as added protection against hand injury, Contractor shall assess the work hazards and ensure suitable hand gloves are provided and used. The Contractor shall provide safety gloves in accordance to EN388 cut resistance rating of 5 and EN Cut Level of F, and EN420 with dexterity rating of for all workmen on site for protection against hand injuries.

25. MONTHLY ENVIRONMENTAL, SAFETY AND SECURITY (ESS) ASSESSMENT

25.1. The Engineer will conduct a monthly ESS Assessment using the form in Attachment A -5 on the Contractor's ESS provision.

25.2. During the Contract period, if the Contractor accumulates monthly ESS scores of less than 65% for three (3) consecutive months; or utility damages based on any of the criteria listed in table below, Contractor's senior management will be called to explain the cause, provide an effective recovery action plan to prevent recurrence, raise safety standards and reinforce their commitment to LTA senior management.

Type of Utility Damages	Total Number of Cases (within any 12 month period)
Results in disruption of service/ system exceeding \$5,000 in repair costs	> 4
Results in disruption of service/ system > 4 hours, or exceed \$10,000 in repair costs	> 3

Type of Utility Damages	Total Number of Cases (within any 12 month period)
Results in disruption of service/ system > 24 hours, or exceed \$100,000 in repair costs	> 1
Total number of cases accumulated regardless of types	> 4

- 25.3. In addition, Contractor with monthly ESS scores of less than 65% for three (3) consecutive months will need to comply with the following requirements:
- a) Send their senior management, project management and site supervisory staff to complete a two (2) days Construction Safety Management Course at LTA Academy at their own expenses within three (3) months.
 - b) There will be increased site visits by LTA senior management. If there are no improvements after three (3) visits, the Contractor's senior management will be called upon to explain to LTA senior management on why there were no improvements.

26. CONTRACTOR SENIOR MANAGEMENT'S SAFETY, HEALTH AND ENVIRONMENTAL (SHE) COMMITMENT PRESENTATION

- 26.1. The Contractor's senior management shall give a presentation on their safety commitments to the Engineer on a six (6) monthly basis or when deemed necessary by the Engineer. Notwithstanding, Clause 26.2 below, the Engineer may make changes to the agenda when deemed necessary.

- 26.2. The agenda for the presentation shall be as follows:
- a) Project Overview and Progress;
 - b) SHE Statistic, MOM Reportable Accidents with MC more than 3 days, Dangerous Occurrence, and lesson learnt;
 - c) Near Miss Reporting, analysis of near misses, action taken to address the findings, and program to encourage near miss reporting;
 - d) Action plan to improve ESS performance;
 - e) Subcontractor's SHE performance;
 - f) Environmental and Safety initiatives, sharing of Good Practices and Adoption of Technology;
 - g) Major Risk and Mitigation Measures for the next 6 months.

27. SAFETY, HEALTH AND ENVIRONMENTAL AUDIT

- 27.1. For contracts with Contract Sums of S\$30 million and above, the Contractor shall ensure their Safety and Health management system is audited according to WSH legislations requirement. The Contractor shall ensure the audit report and its corrective actions are brought to the attention of all sub-contractors and copied to the Engineer.

27.2. Contractor with more than one (1) contract with the Authority shall implement cross-audit program across all his contracts. The cross-audit program shall include documentation review and physical site benchmarking, to be conducted at least once every three (3) months to ensure consistently good SHE performance. Lesson learnt shall be shared across his contracts. The Contractor's management team, WSHE Manager, WSHO and ECO shall be involved in the program. The Contractor shall submit a report on the findings and recommendations made during the cross-audit program to the Engineer.

27.3. Deficiencies identified during the Engineer's insurance and internal audits shall be corrected by the Contractor to the satisfaction of the Engineer.

28. TEMPORARY ELECTRICAL INSTALLATIONS AT THE SITE

28.1. The Contractor shall obtain licenses for using electrical power from their own generating sets.

28.2. The Contractor shall deploy a Licensed Electrical Worker (LEW) on Site on a full-time basis to ensure all temporary electrical installations, equipment and tools are checked and certified safe for use prior to usage on site and after any repairs. The LEW shall provide a sticker on the equipment and tools indicating the date of inspection and that it is safe for use.

28.3. A current photograph of the LEW(s) and their contact number(s) shall be displayed on the outside of all boxes containing electrical DBs for ease of reference. These boxes must be secured with locks to prevent tampering and the keys kept with the LEW / Contractor's Safety Department.

28.4. The Contractor shall ensure that all portable electrical appliances used above and below ground level including are handheld tools and inspection lamps, are rated at 110 volts AC via a step down transformer Centre Tapped to Earth (CTE).

28.5. The Contractor shall ensure all electrical equipment such as generators and welding sets in use on Site are effectively earthed. The earthed points shall be validated by the LEW on a monthly basis or when the equipment is relocated. An inspection tag indicating the specific location, measured ground resistivity and date of test shall be displayed.

29. STORAGE LICENSE FOR PETROLEUM AND FLAMMABLE MATERIALS

29.1. If the Contractor intends to store petroleum and flammable materials on site, he shall obtain a storage licence from SCDF and a copy of the licence shall be submitted to the Engineer.

- 29.2. The Contractor may store petrol up to a maximum volume of 5 litres on Site provided that it is kept in a suitably constructed store which is licensed by the Fire Safety & Shelter Department of the SCDF.
- 29.3. All diesel stored on site shall be kept in drums or in bulk tanks which in either case shall be located at a designated place away from any sources of ignition or open drain which does not lead to an interceptor, and shall be properly labelled. A “No Smoking” sign shall be displayed at the storage location and a charged fire extinguisher of correct type kept on standby.
- 29.4. All bulk diesel tanks shall be properly supported in an elevated position to facilitate gravity discharge. They shall stand within a bund constructed to contain a volume of 110% of the volume of the tank. There shall be no breaches in the bund wall, no material shall be stored within the bund and rainwater collecting in the bund shall be regularly removed to prevent build-up. The inner face of the bund wall shall be coated with a chemical resistant material. A chemical resistant valve, which shall be closed at all times, except for releasing rainwater into a storm water drain via an oil intercepting system, shall be installed at the outlet situated outside the bund, in accordance with the National Environment Agency (NEA) Code of Practice on Pollution Control.
- 29.5. All drums of diesel on Site shall be in good condition and shall be kept closed with a lid/cap when not being used. They shall be stored on end with the lid / cap facing the top so as to prevent leakage and kept within a tray of sufficient volume to contain the contents of the largest drum in the case of accidental rupture, taking into account the presence of other drums within the tray.
- 29.6. Drums of diesel shall not be rolled along the ground. They shall be transported vertically chained on a trolley; or by a forklift fitted with a drum handling device and not standing unsupported on the forks or on a pallet; or by crane using a safe slinging technique.
- 29.7. Diesel shall be transferred from the storage drum to another container, or to the tank of plant/machinery using a hand pump wherever practicable and at all times a drip pan must be provided. Where the diesel container is light enough to be lifted by one person it can be poured out by hand, using a funnel to guide the liquid.
- 29.8. Any spillage of diesel shall straight away be absorbed using sand or other absorbent materials, which shall be disposed of as contaminated waste. On no occasion should diesel be allowed to enter the Site drainage system unless this is connected to an interceptor prior to the Site waste being discharged into the public sewer system.

30. WELDING AND CUTTING

- 30.1. The Contractor shall comply with SS510, Code of Practice for Safety in Welding and Cutting (and other operation involving the use of heat).
- 30.2. When cylinders are used from a pallet, a safety distance of six (6) metres shall be maintained between pallets.
- 30.3. Minimum quantity of gas cylinders should be kept at work locations on Site, and the remainder moved to the designated storage area at ground level. Cylinders should be secured in a vertical position and individual sets should be chained to trolleys or to a fixed support.
- 30.4. The Contractor shall implement a PTW for all hot works to ensure that the equipment are safe for use, free from defects and no incompatible works are carried near the hot work area.
- 30.5. Liquid petroleum gas used below ground shall be subjected to the Engineer's approval. Propane shall be used in a compressed air environment. Oxygen or acetylene cylinders taken underground shall be transported back above ground at the end of each working shift and stored in the designated storage areas.
- 30.6. Workers carrying out welding shall be provided with face shields compatible with safety helmets so that both can be worn at the same time.
- 30.7. Fire blankets shall be provided to contain sparks arising from welding and cutting operations.
- 30.8. Opaque screens shall be securely positioned around any electric arc welding being carried out on Site to protect other workers and passing members of the public, either on foot or as drivers or passengers in vehicles, from the arc. Such screens shall be maintained in good condition.
- 30.9. Cylinder valves shall be protected from damage by protection caps, valve guards or other effective means. Such protective means shall be in place whenever the gas cylinders are not in use or not connected for use.

31. EMERGENCY PREPAREDNESS

- 31.1. The Contractor shall work with the SCDF to establish an emergency preparedness plan to response effectively to emergency situations on site. The plan shall be submitted to the Engineer for his acceptance prior to the commencement of any construction activities and updated at least on a quarterly basis.
- 31.2. In-house emergency exercises and drills shall be conducted on a quarterly basis. Emergency table top exercises with SCDF and all relevant agencies shall be on a half yearly basis while drills shall be at least once a year. The timing for

evacuation of workers and personnel from their work areas shall not be more than 10 minutes.

- 31.3. The Contractor shall design, supply and install proprietary modular tower access with step ladders for access and egress for all work areas including for all excavation works. The design of modular tower access shall be prepared and endorsed by his own Professional Engineer with all necessary calculations, details and drawings. The modular tower access shall be caged with proper LED lighting, handrails, steps and landings, and constructed on proper and stable foundation. The step ladders shall comply with minimum 175mm height riser, 220mm width tread and 1000mm x 2600mm landing area. Any other design proposals that vary from the requirements shall be subjected to the Engineer's acceptance at no additional costs.
- 31.4. There shall be at least 2 modular tower access and egress points at each work areas to ensure safety of workers during emergency evacuations. The Contractor shall conduct regular inspections for the modular tower access at all stages of the Works and shall maintain these accesses throughout the entire period of use until removal. The Contractor shall only dismantle and remove the modular tower accesses as directed by the Engineer. The cost for the supply, installation, operation, maintenance and removal of these modular tower accesses is deemed included in the Contract Price.
- 31.5. The Contractor shall provide LED lights along the Emergency Escape stairways and routes for ease of emergency evacuations.
- 31.6. The emergency preparedness plan shall also include:
- a) environmental pollution scenarios such as spillages of unauthorised / pollutive materials into sewage, watercourses or land.
 - b) Safe Management Measure (SMM) plan for infectious/contagious disease. e.g. Covid-19, etc. Refer to Annex A-x

32. FIRE SAFETY PLAN

- 32.1. The Contractor shall establish a Fire Safety Plan to ensure that the work on site is undertaken to the highest standard of fire safety. As a basic guide the Contractor shall address the requirements contained in the Joint Code of Practice on the Protection from Fire of Construction Sites and Buildings Undergoing Renovation - under the title "Fire Prevention on Construction Sites" published by the Construction Confederation and the Fire Protection Association of U.K. as well as the "Technical Guidelines For Fire Safety In Temporary Buildings In Construction Sites" issued by the SCDF.
- 32.2. The plan shall be submitted to the Engineer for acceptance and shall detail as a minimum:

- the role and responsibility of every individual in the worksite on fire safety;
- general site precautions, fire detection and warning alarm system;
- fire fighting equipment including types of fire extinguishers;
- fire safety measures for site accommodation;
- fire escape and communication;
- fire brigade access, facilities and co-ordination;
- fire drills and training including the use of site firefighting apparatus;
- material storage including flammable liquid and gas, and waste control regime;
- fire safety measures for construction plant and equipment; and
- fire safety measures for electrical supply.

32.3. The Contractor shall ensure that all procedures, precautionary measures and safety standards stipulated in the Fire Safety Plan are implemented, communicated and complied with by all workers including sub-contractors and interfacing contractors.

32.4. The Contractor shall review and ensure the adequacy of the Fire Safety Plan as the Works progress.

32.5. The Contractor shall carry out monthly checks of firefighting equipment and test all alarms and detection devices installed on site. Tags / stickers shall be provided to indicate the monthly checks.

32.6. The Contractor shall conduct weekly inspections of escape routes, fire brigade access, firefighting facilities and work areas to ensure that the requirements stipulated in the Fire Safety Plan are complied with.

33. WORK IN CONFINED SPACES

33.1. In addition to the requirements of the Workplace Safety and Health (Confined Spaces) Regulations and SS 568, Code of Practice for Confined Spaces, the Contractor shall also classify manholes, enclosed formwork, culvert drains, excavations more than four (4) metres deep, partially enclosed excavations and tunnels as confined spaces and apply all legislative requirements of confined spaces.

33.2. The Contractor shall have controlled access / egress points to confined spaces to prevent unauthorised access. Where practicable the Contractor shall ensure that there are at least two (2) readily accessible escape routes from each confined space.

33.3. The Contractor shall operate a tag system for entry so that all personnel entering the confined space can be accounted for.

- 33.4. The Contractor shall ensure that there is a certified man-riding cage capable of taking a stretcher and two persons, together with an identified crane equipped with rescue equipment, on standby at all times whilst work is carried out in the confined space. Where this is not reasonably practicable a stretcher which is capable of being brought manually out of the confined space should be located at a convenient point.
- 33.5. Gas monitoring shall be conducted by a competent confined space assessor to certify that the confined space is safe for workers to enter and thereafter at every four (4) hours intervals.
- 33.6. In addition, the Contractor shall ensure that suitable atmospheric monitoring devices such as anemometer and wet/dry bulb thermometer are made available for the competent confined space assessor to determine the air flow, ambient temperature and humidity level within the confined space.

34. ILLUMINATION

- 34.1. The Contractor shall provide temporary general illumination with a lighting level of not less than 100 lux for all work areas.

35. WELFARE PROVISIONS

- 35.1. Sanitary and washing facilities shall be provided in accordance with the Code of Practice on Environmental Health and the Workplace Safety & Health Act. Toilet facilities shall be connected to a sewer/temporary septic tank with the approval of the Sewerage Department.
- 35.2. The Contractor shall provide suitable and sufficient temporary facilities on Site which are readily accessible taking into account the number and distribution of workers throughout all work locations.
- 35.3. These facilities shall include:
- a) Toilets and hand wash areas;
 - b) A supply of clean drinking water; and
 - c) Sheltered rest areas; to be provided with tables, chairs, lightings and fans, are segregated from the worksite so that workers may safely remove helmets and other items of PPE. Such rest areas shall have sufficient waste bins.
- 35.4. These facilities shall be kept in a clean and serviceable condition and be available for use during all working hours. The locations may need to be air-conditioned if situated at bored tunnel and/or well ventilated if at station area.

- 35.5. Portable toilets shall be provided at suitable and accessible locations including in underground structures under construction. They shall be regularly serviced and maintained in a hygienic condition

36. FIRST AID PROVISIONS

- 36.1. An approved first aid station shall be provided and maintained at all times. The station shall be fully equipped to treat illness and injuries which can normally be expected to occur in work of the types required by this Contract. Medical supplies shall be stocked in the types and quantities recommended by the designated doctor.
- 36.2. The first aid station shall be located near the main access to the Site, readily accessible to ambulance service.
- 36.3. An additional number of trained first aiders and satellite first aid boxes or cupboards shall be provided and maintained to give effective first aid cover to the whole worksite, including any related off-site activities.
- 36.4. Where work is carried out during extended hours or on a shift system the Contractor shall ensure that there are sufficient trained first aiders on Site to give effective cover at all hours.
- 36.5. The first aid station and the satellite first aid boxes or cupboards shall be placed under the charge of WSHO who shall be trained in first aid treatment, and he, or a nominated qualified deputy, shall always be readily available during the hours where work is carried out on Site.
- 36.6. In addition to clause 36.5, Contractor shall provide and maintain Automated External Defibrillators (AED). AEDs shall be readily accessible and all first aiders are to be trained in its correct use.
- 36.7. Qualified first aiders shall be suitably identified with a logo of a green cross on their safety helmets.
- 36.8. In addition, an approved first aid box or cupboard, a stretcher and a telephone for each satellite Site shall be provided and maintained so as to be readily accessible.

37. LADDERS

- 37.1. The Contractor shall use step platforms instead of A-frame ladders for works at height subjected to the Engineer's approval (examples of step platforms can be found in Annex A-r) and establish a Permit-To-Work system for such works. In addition, for works in excess of three (3) metres, the Contractor shall demonstrate the stability of these step platforms to prevent toppling.

37.2. Ladders (step platforms and vertical ladders) shall comply to SS EN131. No vertical ladders exceeding three (3) meters is allowed on site.

37.3. The Contractor shall implement a step platform/ladder inspection procedure requiring an identification method displaying company name, unique number, inspection frequency and inspection status.

38. SCAFFOLDS

38.1. The Contractor shall develop a scaffold tagging system acceptable to the Engineer to indicate:

- a) Scaffolds under construction or dismantling;
- b) Scaffolds that are complete but have hazards associated with them; and
- c) Scaffolds that have been erected and are safe for use.

38.2. The Contractor shall envelope all scaffolds with screen nets to prevent debris from falling outside the scaffold.

38.3. Scaffold Regulations shall be applicable to the erecting and dismantling of falseworks.

38.4. The Contractor shall use only proprietary access ladders and working platforms for system formworks. No mix and match using conventional catwalks and monkey ladders is allowed.

39. GENERAL SAFETY

39.1. The Contractor shall provide, erect, maintain and finally remove, when instructed, Danger, Warning, Caution or Information signs, located appropriate to the site layout. The signs shall be no less than 1.5m x 1.0m in size written boldly in the four official languages. These shall be erected on existing footpaths and at points of access likely to be used by the public to warn or inform them of the existence of the Works. These notices shall be in addition to any notices required to be put up to meet statutory requirements.

39.2. The Contractor shall ensure that all roads, pavements and public footpaths are kept clear of dust, silt and debris.

39.3. Unless otherwise agreed, the Contractor shall be responsible for the proper fencing, hoarding, lighting, guarding and watching of the Works. The Contractor shall also provide proper temporary roadways, footways, guards, fencing and hoardings so far as the same may be necessary for the accommodation and protection of the owners and occupiers of the adjacent property, the public and others for a like period.

- 39.4. All platforms, covers, ladders, stairways, staging, scaffolding and other provisions for access erected by the Contractor shall be installed in compliance with current legal requirements and made available for use as early as possible during the construction period. In cases where this is impracticable the Contractor shall provide all necessary temporary access facilities which shall be constructed, installed and maintained in a safe and secure manner.
- 39.5. Designated walkways along walers and struts shall be levelled, flushed without tripping hazards and with rigid guardrails and toe boards securely provided.
- 39.6. Fall Arrest System, including but not limited to lifelines and anchors, shall be designed by a Professional Engineer (PE) and complied with the requirements of SS 528 and SS570.
- 39.7. The Contractor shall provide capping on all protruding starter reinforcement bars with individual plastic / rubber caps or with hose /tube.
- 39.8. The Contractor shall ensure bar chairs supporting steel reinforcement bars shall be designed by a Professional Engineer. In his design, the bar chair should only be welded to temporary bars incorporated to support the bar chairs. Welding onto permanent bars shall not be permitted.
- 39.9. The Contractor shall ensure that horseplay, practical jokes, scuffling, wrestling or fighting are strictly prohibited at the Site.
- 39.10. The Contractor shall ensure that the sale, keeping or consumption of liquor and prohibited substances on Site is prohibited.
- 39.11. No gambling, prostitution or other illegal or immoral activities shall be allowed anywhere else on Site.
- 39.12. The Contractor shall ensure that the canvas used for covering materials and / or equipment are of fire-retardant type.
- 39.13. For excavator fitted with quick coupler assembly, the security pin and surrounding area shall be painted with a bright colour for positive visual identification that the bucket is secured. In addition, pictorial safety instructions from the excavator manual on the proper use of quick coupler assembly are to be prominently displayed in the cabin for reference.

39.14. The Contractor shall adopt the innovative solutions and use of technology to enhance safety of the worksites. Contractor shall bring in newer machineries that comes with factory fitted safety devices or retrofit approved safety devices onto existing machineries used on site. These machineries shall include:

- Excavator
- Crawler Crane
- Boring Rig
- D-wall machine

39.14.1 The safety devices mentioned in clause 39.14 shall include:

- a) Driver Fatigue Management System
- b) Proximity Sensing and Warning Sensors
- c) Camera Monitor System

a) Driver Fatigue Management System

- Detect signs of driver fatigue and distractions when heavy equipment is in operation, including but not limited to drowsiness, dozing off, using mobile device, looking away, eating, and smoking.
- Alert heavy equipment operator and supervisor in real-time when driver fatigue or distraction is detected.
- Provide analytical dashboard and reports for reporting and trend analysis.
- Provide training and demonstrate that operators and supervisors have received training in the care, maintenance, safety rules, use and limitations of the system.
- Perform regular maintenance and reinstate to working condition when the system malfunctions.
- Obtain necessary approval from vehicle manufacturers if the system requires tapping into the electronics and control systems of the heavy vehicles/equipment
- Ensure visual and audio alerts are unique such that operators and supervisors can differentiate whether the alerts are from this Driver Fatigue Management System, or from other system such as the Proximity Sensing and Warning Sensor.
- Ensure that the system, including the alerts cannot be bypassed or turned off by operator during equipment operation.

b) Proximity Sensing and Warning Sensors

- Alert the heavy equipment operator when a person or object is detected in the AOR* and blind area and trigger an alarm with blinker to warn the person at risk. If the alarm is not audible for the operator, there should be a separate alarm in the operator cabin and a digital display if appropriate.

- False alarms shall be minimised by getting the suitable model or customisable by solution vendor to ensure that the false alarm rate is as low as reasonably practicable.
- Perform reliably in adverse climatic and weather conditions.
- Allow for configuration of detection distance required.
- Provide training and demonstrate that operators and supervisors have received training in the care, maintenance, safety rules, use and limitations of the system.
- Perform regular maintenance and reinstate to working condition when the system malfunctions.
- Obtain necessary approval from vehicle manufacturers if the system requires tapping into the electronics and control systems of the heavy vehicles/equipment.
- Ensure visual and audio alerts shall be unique such that operators and supervisors can differentiate whether the alerts are from this Proximity Sensing and Warning Sensor, or from other system such as Driver Fatigue Management System.
- Ensure that the system, including the alerts cannot be bypassed or turned off by operator during equipment operation. Any bypass required for operational needs, e.g. if vehicle is parked beside a wall, shall be controlled by the supervisor or other authorised personnel.

* Areas Of Risk (AOR) is defined as areas of obstructed view that would fall within the equipment's direction of movement, where a person or object cannot be seen by the equipment operator in the normal operating position, either by direct line-of-sight or even with the use of mirrors.

c) Camera Monitor System

- Provide heavy equipment operator with visual monitors in the cabin to have a clear image of a person or object in the AOR
- The image of a person or object in the LCD monitor must be clear and easily identifiable.
- Perform reliably in adverse climatic and weather conditions.
- Allow for capturing of video data for retrieval, playback and analysis.
- Provide training and demonstrate that operators and supervisors have received training in the care, maintenance, safety rules, use and limitations of the system, such as reminders that the camera is a supplement device that still requires the operator to use it in conjunction with the vehicle mirrors or systems for maximum coverage.
- Perform regular maintenance and reinstate to working condition when the system malfunctions.
- Obtain necessary approval from manufacturers if the system requires tapping into the electronics and control systems of the machines.
- Ensure that the system cannot be turned off by operator during equipment operation.

- 39.15. The Contractor shall ensure all soil investigation rig used on site are installed with limit switch and warning light/alarm to prevent over hoisting of the lifting gear assembly. For rigs without electrical power, e.g. A-frame rigs, to install a mechanical stopper to protect the pulley from over hoisting of the lifting gear assembly.

40. SAFETY (ANTI-FALL) NET

- 40.1. The Contractor shall provide and maintain safety net system in compliance to SS292 Specification for Safety Nets for Construction Sites to catch persons falling whilst working in any location from where he would liable to fall. The net shall be of sufficient size and strength to catch any person for whose protection it is to be used and the net shall be so located to cover the area of the possible fall.
- 40.2. The Contractor shall conduct a sample test on the safety net system, comprising the net and its supporting structures, before it is installed. Subsequent tests shall be carried out when directed by the Engineer.

41. BARRICADE / COVER TO VOIDS, TRENCH, BORED HOLES AND OPEN EDGES OF STRUCTURE

- 41.1. The Contractor shall barricade all excavation, bored holes, voids and open edges of structures under construction where a workman is liable to fall with secured and effective guardrails / barricades / floor coverings.
- 41.2. The Contractor shall provide “Danger” warning signs for barriers and barricades erected. All floor opening covers shall be stencilled or painted with “Danger, Do Not Remove”. For details on the protection to floor openings refer to Annex A-p “Protection of Slab Openings”.
- 41.3. Where traffic flow is to be maintained over temporary road opening or crossing, the Contractor shall provide suitably designed chequered steel cover / decking over it. The Contractor’s Professional Engineer shall design and submit the cover / decking proposal to the Engineer for acceptance prior to commencement of the excavation.

42. 5S HOUSEKEEPING METHOD

- 42.1. The Contractor shall implement a 5S housekeeping method approved by the Engineer. The method shall be based on a Japanese quality management concept based on cyclical methodology. The 5S shall consist of Seiri (Sort / Organise), Seiton (Straighten / Orderliness), Seiso (Sweep / Cleanliness), Seiketsu (Standardise) and Shitsuke (Sustain / Discipline).

43. BEHAVIOURAL BASED SAFETY (BBS)

43.1. The Contractor shall send a site senior management staff and a WSHO to attend the Engineer's in-house BBS training.

43.2. The Contractor shall implement a BBS programme based on the training provided by the Engineer. The BBS programme shall be approved by the Engineer before implementation.

43.3. The BBS programme shall include:

a) Conduct a Safety Culture Survey through questionnaires. The Contractor shall ensure that the Safety Culture Survey is conducted effectively and interpreters shall be appointed if necessary;

b) Training of management staff, site supervisory staff, workers and the appointed observers.

Assigned Observers to conduct observations of safe and unsafe behaviours. The Observers appointed shall base on the ratio of 1 Observer to 50 workers. Each Observer shall conduct regular observations of minimum twice a week with durations of about 20 minutes each.

c) Direct Observers to input observations into the Engineer's BBS Database System for monitoring and analysis.

d) Organise goal setting committees chaired by senior site management and introduce intervention strategies to correct the unsafe behaviours for continual improvement.

e) Submit a monthly BBS implementation progress report within 5 days after the end of each month. The report shall include project profile, executive summary of BBS activities such as types of critical behaviours and intervention strategies, detailed listing of behaviours observed with the respective goals set and statistical analysis of the behaviours supported graphs.

44. CLOSED-CIRCUIT TELEVISION (CCTV)

44.1. The Contractor shall implement a surveillance CCTV system, with cameras strategically positioned at high-risk areas for purpose of monitoring site conditions and deterring unsafe work practices. The number and location of cameras deployed shall be subjected to the acceptance of the Engineer.

- 44.2. The CCTV shall facilitate viewing of live and recorded images. Access to viewing and controlling of all cameras shall be via a standard web browser and/or wireless Local Area Network (LAN) by the authorized users. All cameras shall be weatherproof and come with pan/tilt functions, zoom lens and the ability to operate under low light conditions.
- 44.3. All camera recordings shall have camera ID and location / area of recording as well as date/time stamp which cannot be altered, ensuring the audit trail is intact for evidential purposes. Sufficient storage (hard disk space) shall be provided for all the camera recordings for a period of 30 days or more @ 30 frames per second (FPS), at four (4) common intermediate format (CIF) or better quality using the necessary compression techniques for all cameras. A backup system shall be maintained to protect against server or storage failure.
- 44.4. The storage system should allow retrieval of data instantaneously or any date / time interval chosen through search functionality of the application software. The system shall have the facility to export the desired portion of clipping (from a desired date/time to another desired date / time) onto a CD, DVD or any other device in a format which can be replayed through standard PC based software.

45. TRAFFIC CONTROL AND ROAD SAFETY

- 45.1. The Contractor shall provide, install and maintain all necessary traffic and directional signs, barriers, blinkers, rotating beacons, cones, lane markings etc. in accordance with the requirements stipulated in the Code of Practice for Traffic Control at Work Zone (latest edition) to guide and inform the public of road works or any road lane closure. The Contractor must observe the minimum clearance required between the working area and the trafficked carriageway and ensure that all plants and materials do not intrude into any area reserved for pedestrians, cyclists or other traffic.
- 45.2. The Contractor shall regularly maintain the site road surfaces to keep them free of potholes, unevenness, etc. Mill and patch method shall be required to repair any uneven surface defects.
- 45.3. The Contractor shall ensure all materials including precast units transported via heavy service vehicles, prime-movers and trailers are safely secured in accordance with SS 663 Code of Practice for Safe Loading on Vehicles and Workplace Safety and Health Guidelines for Safe Loading on Vehicles.

46. USAGE OF NEW HEAVY EQUIPMENT IN LTA WORKSITES

- 46.1. All new heavy equipment to be used in LTA worksites shall be subjected to approval of the Engineer. Please refer to Annex A-f for details.

47. SITE CLEARANCE INCLUDING TREE FELLING AND TRANSPLANTING WORKS

- 47.1. An arborist shall be engaged prior to the commencement of any site clearance or tree felling and transplanting activities. The appointed arborist shall be subject to the Engineer's approval. The arborist shall submit a proposal on the tree type(s) that require his supervision during felling and/or transplanting. For trees that have been identified by the arborist as requiring special attention, specific method statements and risk assessments with detailed diagrams on the tree removal method has to be endorsed by the arborist before the tree removal operation commences.

48. SHE SHARING & SITE VISITS

- 48.1. The Contractor shall facilitate and host visits by other Contractors to his worksites and to share his SHE management experiences with them.
- 48.2. The Contractor's management team shall attend visits to other LTA worksites with good SHE management initiatives and skills when directed by the Engineer and to learn and implement the good initiatives at his site.

49. WORKING IN DEFINED AREAS

- 49.1. Defined Area work comes into effect during the track related installation process (TRIP) which takes place after substantive civil work has been completed. Working in defined areas shall comply with the issued Works Train Manual.

50. RESTRICTED USAGE OF HANDPHONE

- 50.1. All workers / operators are banned from using handphone / MP3 devices at LTA worksites. The handphones are to be surrendered to respective supervisors and stored away at rest areas with lockers. Workers / Operators are only allowed to use their handphones / MP3 during rest times and breaks. Exceptions for specific workers (e.g. surface watchman for tunnelling works) shall be considered on need-to-basis and LTA's approval is required.
- 50.2. For foreman and above, handphone usage is allowed only at designated safe zones. The handphone users needs to adopt safe mode (stop walking and observe surrounding) prior to answering of call.

51. MOBILISATION AND DEMOBILISATION OF MACHINERY

51.1. The Contractor shall ensure that for mobilisation and demobilisation of any machinery on site there is approved method statement and risk assessment conducted. The ramps of trailers used for mobilisation and demobilisation of machinery shall be able to accommodate the width of machinery tracks. The Ramp angle shall adhere strictly to the machinery manufacturer's recommendation (Refer to Annex A-a Clause 4 for details).

52. TOTAL WORKPLACE SAFETY AND HEALTH (TOTAL WSH)

52.1. The contractor shall implement Total Workplace Safety and Health (WSH) programme throughout the construction phases on the worksite. Total WSH is an approach that looks at safety and health together at work to achieve healthy workforce and safe workplace.

52.2. The Total WSH programme shall educate workers on how to better take care of their safety and health through modular activity packages.

52.3 The contractor shall use the Total WSH A-I-ME framework for their Total WSH programme.

- a) A is Assessment
- b) I is Intervention Programmes
- c) ME is Monitoring & Evaluation

53. ANNEXES

53.1. The Contractor shall also comply with the following annexes to this appendix.

- a) Lifting Operations;
- b) Site Transport;
- c) Site Security;
- d) Civil Engineering / Deep Excavations;
- e) Temporary Housing Quarters;
- f) Approval Procedure for Usage of New Heavy Equipment in LTA worksites;
- g) Environmental Considerations;
- h) Biodiversity
- i) Flooding;
- j) Marine Works;
- k) Contaminated Ground;
- l) D&B Rail Projects Civil Design Safety Submissions;
- m) Build Only Rail Projects Civil Design Safety Submissions;

- n) D&B Road Projects Civil Design Safety Submissions;
- o) Build Only Road Projects Civil Design Safety Submissions;
- p) Protection of Slab Openings
- q) Safe Installation and Maintenance of Sliding Gates (both permanent and temporary)
- r) Photographs showing good SHE practices;
- s) Mobile Elevated Working Platform (MEWP) Usage On Site;
- t) Electronic Safety, Health and Environmental Management System (e-SHEMS);
- u) Designed For Safety (DfS) and Designed For Safety Professional (DfS Professional);
- v) Safe Work Procedure for Controlling Movement of Heavy Machineries;
- w) Formwork Structures;
- x) Safe Management Measures
- y) Construction Site Machinery Key Management Procedures

LAND TRANSPORT AUTHORITY SAFETY, HEALTH AND ENVIRONMENTAL MANAGEMENT MANUAL	
ACCIDENT OCCURRENCE REPORT FORM	LTA REF NO : _____
Accident Title	
Name of Main Contractor : _____ Report Ref No : _____	
PART A (Type of Accident) <input type="checkbox"/> Accident (MOM reportable-More than 3 days MC) <input type="checkbox"/> Accident (3 days or lesser or light duties) <input type="checkbox"/> Occupational Disease	
PART B (Details of Accident) PROJECT : _____ CONTRACT : _____ EXACT LOCATION : _____ OCCURRENCE DATE : _____ OCCURRENCE TIME : _____ REPORTED DATE : _____ REPORTED TIME : _____	
PART C (Details of Injured Person) NAME : _____ EMPLOYER : _____ DATE OF BIRTH : _____ NRIC/FIN NO : _____ GENDER : _____ OCCUPATION : _____ CITIZENSHIP : _____ DATE JOINED SERVICE : _____ RACE : _____ PREVIOUS INDUSTRY EXPERIENCE & DESIGNATION : _____ MARITAL STATUS : _____ SKILL LEVEL : R1 (Higher Skilled Worker) / R2 (Basic Skilled Worker) [delete accordingly] EMPLOYEE SENT TO : <input type="checkbox"/> First Aid <input type="checkbox"/> Home <input type="checkbox"/> Private Doctor <input type="checkbox"/> Hospital : _____ (hospital name) <input type="checkbox"/> Polyclinic : _____ (polyclinic name)	
PART D (Lost time) <u>Estimated (if actual mandays lost is not available)</u> <input type="checkbox"/> 3 days or lesser <input type="checkbox"/> More than 3 days <input type="checkbox"/> Hospitalised more than 24 hours <input type="checkbox"/> Immediate return to work <input type="checkbox"/> First aid given only <input type="checkbox"/> Light duty <u>Actual</u> State actual no. of mandays lost : _____ Period of Medical Leave : _____ State actual light duty mandays (if applicable) : _____	

**LAND TRANSPORT AUTHORITY
SAFETY, HEALTH AND ENVIRONMENTAL
MANAGEMENT MANUAL**



ACCIDENT OCCURRENCE REPORT FORM

PART E (Details of Injury)

Use the following codes :

Nature of Injury

- ABR** : Abrasions / Scratches
- AMP** : Amputation
- ASP** : Asphyxia / Drowning
- BCC** : Bruises / Crushing / Contusions
- BN(C)** : Chemical Burns
- BN(H)** : Heat Burns
- CAI** : Compressed Air Illness or its Sequelae
- CCS** : Concussion / Internal Injury
- DEATH** : Fatality
- DIS** : Dislocation
- ELECT** : Effects of Electricity
- EYE** : Eye Injury
- FG** : Faint / Giddy
- FT** : Fracture
- FZ** : Freezing / Frostbite / Hypothermia
- HEAT** : Heat stress and strain
- LC** : Laceration / Cut
- NID** : Noise Induced Deafness
- NUMB** : Numbness
- PERM** : Permanent Disability
- PS** : Physical Shock
- PSN** : Poisoning
- PW** : Puncture wound
- RDT** : Effects of radiation
- SKIN** : Dermatitis / Skin disease
- SS** : Sprain / Strain
- TOOTH** : Tooth Injury
- OTHER** : Other Injury
- NA** : Not applicable

Injured Bodypart

- BODY** : Injury linked to entire body
- FEET** : Feet / Toes
- HAND** : Hand / Fingers
- HEAD** : Head / Face / Neck
- LOWER** : Lower Limbs (Legs)
- TORSO** : Shoulder to Groin / Hip
- UPPER** : Upper Limbs (Arms)
- NA** : Not Applicable

<u>Nature of Injury</u>	<u>Injured Bodypart</u>	<u>Exact description (state Left / Right bodypart)</u>
<input type="text"/>	<input type="text"/>	<input type="text"/>
<input type="text"/>	<input type="text"/>	<input type="text"/>
<input type="text"/>	<input type="text"/>	<input type="text"/>
<input type="text"/>	<input type="text"/>	<input type="text"/>

**LAND TRANSPORT AUTHORITY
SAFETY, HEALTH AND ENVIRONMENTAL
MANAGEMENT MANUAL**



ACCIDENT OCCURRENCE REPORT FORM

PART F (Description of Accident)

WHAT HAPPENED? HOW DID IT HAPPEN? WHAT WERE THE CONSEQUENCES? PLEASE ATTACH PHOTOGRAPHS AND SKETCHES.

**LAND TRANSPORT AUTHORITY
SAFETY, HEALTH AND ENVIRONMENTAL
MANAGEMENT MANUAL**



ACCIDENT OCCURRENCE REPORT FORM

PART G (Causes of Accident)

(1) Direct Causes

(i) Unsafe Conditions

- | | |
|--|--|
| <input type="checkbox"/> Absence of safety means | <input type="checkbox"/> Inadequate warning system |
| <input type="checkbox"/> Congestion / restricted action | <input type="checkbox"/> Inadequate / improper PPE |
| <input type="checkbox"/> Dressing / apparel hazard | <input type="checkbox"/> Inclement weather conditions |
| <input type="checkbox"/> Environmental hazard (gas / dust / smoke) | <input type="checkbox"/> Noise hazard |
| <input type="checkbox"/> Floor surface hazards (slips / trips / falls) | <input type="checkbox"/> Poor housekeeping |
| <input type="checkbox"/> Hazardous arrangement | <input type="checkbox"/> Presence of fire / explosion hazard |
| <input type="checkbox"/> High temperature hazard | <input type="checkbox"/> Radiation hazard |
| <input type="checkbox"/> Improper / faulty equipment | <input type="checkbox"/> Unknown ground conditions |
| <input type="checkbox"/> Inadequate guarding / protection / precaution | <input type="checkbox"/> Unsound structure |
| <input type="checkbox"/> Inadequate illumination | <input type="checkbox"/> No unsafe condition |
| <input type="checkbox"/> Inadequate ventilation | |

Remarks :

(ii) Unsafe Practice

- | | |
|---|---|
| <input type="checkbox"/> Disregard instructions | <input type="checkbox"/> Not paying attention |
| <input type="checkbox"/> Driving / operating error | <input type="checkbox"/> Operating / working at unsafe speed |
| <input type="checkbox"/> Failure to secure / warn | <input type="checkbox"/> Operating / working without authority |
| <input type="checkbox"/> Horseplay | <input type="checkbox"/> Taking improper / unsafe position or posture |
| <input type="checkbox"/> Improper use of fail to use PPE | <input type="checkbox"/> Taking shortcuts |
| <input type="checkbox"/> Improper / unsafe lifting / carrying | <input type="checkbox"/> Tampering with equipment in motion |
| <input type="checkbox"/> Improper / unsafe use of equipment/materials | <input type="checkbox"/> Under influence of alcohol / drugs |
| <input type="checkbox"/> Improper / wrong use of body part | <input type="checkbox"/> Unsafe loading / mixing / placing |
| <input type="checkbox"/> Intentional motive | <input type="checkbox"/> Wrong working methods |
| <input type="checkbox"/> Making safety devices inoperative | <input type="checkbox"/> No unsafe practice |

Remarks :

(2) Root Causes

(i) Work Factors

- | | |
|---|--|
| <input type="checkbox"/> Inadequate equipment being used | <input type="checkbox"/> Lack of co-ordination / communication |
| <input type="checkbox"/> Inadequate / lack of engineering | <input type="checkbox"/> Poor selection / placement |
| <input type="checkbox"/> Inadequate / lack of maintenance | <input type="checkbox"/> Pressure from external influence |
| <input type="checkbox"/> Inadequate / lack of supervision | <input type="checkbox"/> Wear and tear |
| <input type="checkbox"/> Inadequate / lack or work procedures | <input type="checkbox"/> No work factors |

Remarks :

**LAND TRANSPORT AUTHORITY
SAFETY, HEALTH AND ENVIRONMENTAL
MANAGEMENT MANUAL**



ACCIDENT OCCURRENCE REPORT FORM

(ii) Human Factors

- | | |
|--|--|
| <input type="checkbox"/> Fatigue | <input type="checkbox"/> Lack of skill |
| <input type="checkbox"/> Foul play | <input type="checkbox"/> Lack of training |
| <input type="checkbox"/> Illness | <input type="checkbox"/> Needs conflicting with safety |
| <input type="checkbox"/> Improper assignment of personnel | <input type="checkbox"/> Not qualified |
| <input type="checkbox"/> Improper or lack of motivation / interest | <input type="checkbox"/> Unsafe attitude |
| <input type="checkbox"/> Inadequate capability | <input type="checkbox"/> No human factors |
| <input type="checkbox"/> Lack of knowledge | |

Remarks :

(3) Weakness of Safety Management System

- | | |
|--|--|
| <input type="checkbox"/> Safety policy | <input type="checkbox"/> Safe work practices |
| <input type="checkbox"/> Safety training | <input type="checkbox"/> Group meetings |
| <input type="checkbox"/> Incident investigation and analysis | <input type="checkbox"/> In-house safety rules and regulations |
| <input type="checkbox"/> Safety promotion | <input type="checkbox"/> Evaluation, selection and control of SC |
| <input type="checkbox"/> Safety inspections | <input type="checkbox"/> Maintenance regime for all machinery |
| <input type="checkbox"/> Hazard analysis | <input type="checkbox"/> Control of movement and use of hazardous substances and materials |
| <input type="checkbox"/> Emergency preparedness | <input type="checkbox"/> Not applicable |
| <input type="checkbox"/> Occupational health programs | |

Remarks :

PART H

RECOMMENDATION	ACTION TAKEN

**LAND TRANSPORT AUTHORITY
SAFETY, HEALTH AND ENVIRONMENTAL
MANAGEMENT MANUAL**



ACCIDENT OCCURRENCE REPORT FORM

PART I (Details of Investigating Person)

NAME : _____

DESIGNATION : _____

COMPANY : _____

TEL : _____ **DATE** : _____ **SIGN** : _____

PART J (Reviewed By)

NAME : _____

DESIGNATION : _____

COMPANY : _____

TEL : _____ **DATE** : _____ **SIGN** : _____

PART K (Form Completed By)

NAME : _____

DESIGNATION : _____

COMPANY : _____

TEL : _____ **DATE** : _____ **SIGN** : _____

LAND TRANSPORT AUTHORITY SAFETY, HEALTH AND ENVIRONMENTAL MANAGEMENT MANUAL																																																									
INCIDENT OCCURRENCE REPORT FORM	LTA REF NO : _____																																																								
Incident Title																																																									
Name of Main Contractor: _____ Report Ref. No : _____																																																									
PART A (Type of Incident) <input type="checkbox"/> Dangerous Occurrence (MOM Reportable) <input type="checkbox"/> Near miss <input type="checkbox"/> Near Miss (Cat A) <input type="checkbox"/> Damage to property <input type="checkbox"/> Dangerous incident <input type="checkbox"/> Security violation <input type="checkbox"/> Damage to utilities <input type="checkbox"/> Fire <input type="checkbox"/> Environmental harm <input type="checkbox"/> Road incident <input type="checkbox"/> Other occurrence <input type="checkbox"/> Crime																																																									
PART B (Details of Incident) PROJECT : _____ CONTRACT : _____ EXACT LOCATION : _____ OCCURRENCE DATE : _____ OCCURRENCE TIME : _____ REPORTED DATE : _____ REPORTED TIME : _____ COMPANY RESPONSIBLE FOR INCIDENT : _____																																																									
PART C (Persons involved in the Incident) <table style="width:100%; border-collapse: collapse;"> <thead> <tr> <th style="width:33%;"></th> <th style="width:33%; text-align: center;">A</th> <th style="width:33%; text-align: center;">B</th> <th style="width:33%; text-align: center;">C</th> </tr> </thead> <tbody> <tr> <td>NAME :</td> <td>_____</td> <td>_____</td> <td>_____</td> </tr> <tr> <td>DESIGNATION :</td> <td>_____</td> <td>_____</td> <td>_____</td> </tr> <tr> <td>COMPANY :</td> <td>_____</td> <td>_____</td> <td>_____</td> </tr> </tbody> </table> <p>Status (you may tick more than one) :</p> <table style="width:100%; border-collapse: collapse;"> <thead> <tr> <th style="width:10%;"></th> <th style="width:10%;">Witness</th> <th style="width:10%;">Incident Reporter</th> <th style="width:10%;">LTA Personnel</th> <th style="width:10%;">Main Contractor's Personnel</th> <th style="width:10%;">Subcontractor's Personnel</th> <th style="width:10%;">Visitor</th> <th style="width:10%;">Public</th> <th style="width:10%;">Self Employed</th> <th style="width:10%;">Others : _____</th> </tr> </thead> <tbody> <tr> <td>A</td> <td><input type="checkbox"/></td> <td><input type="checkbox"/></td> <td><input type="checkbox"/></td> <td><input type="checkbox"/></td> <td><input type="checkbox"/></td> <td><input type="checkbox"/></td> <td><input type="checkbox"/></td> <td><input type="checkbox"/></td> <td><input type="checkbox"/></td> </tr> <tr> <td>B</td> <td><input type="checkbox"/></td> <td><input type="checkbox"/></td> <td><input type="checkbox"/></td> <td><input type="checkbox"/></td> <td><input type="checkbox"/></td> <td><input type="checkbox"/></td> <td><input type="checkbox"/></td> <td><input type="checkbox"/></td> <td><input type="checkbox"/></td> </tr> <tr> <td>C</td> <td><input type="checkbox"/></td> <td><input type="checkbox"/></td> <td><input type="checkbox"/></td> <td><input type="checkbox"/></td> <td><input type="checkbox"/></td> <td><input type="checkbox"/></td> <td><input type="checkbox"/></td> <td><input type="checkbox"/></td> <td><input type="checkbox"/></td> </tr> </tbody> </table>			A	B	C	NAME :	_____	_____	_____	DESIGNATION :	_____	_____	_____	COMPANY :	_____	_____	_____		Witness	Incident Reporter	LTA Personnel	Main Contractor's Personnel	Subcontractor's Personnel	Visitor	Public	Self Employed	Others : _____	A	<input type="checkbox"/>	<input type="checkbox"/>	<input type="checkbox"/>	<input type="checkbox"/>	<input type="checkbox"/>	<input type="checkbox"/>	<input type="checkbox"/>	<input type="checkbox"/>	<input type="checkbox"/>	B	<input type="checkbox"/>	<input type="checkbox"/>	<input type="checkbox"/>	<input type="checkbox"/>	<input type="checkbox"/>	<input type="checkbox"/>	<input type="checkbox"/>	<input type="checkbox"/>	<input type="checkbox"/>	C	<input type="checkbox"/>	<input type="checkbox"/>	<input type="checkbox"/>	<input type="checkbox"/>	<input type="checkbox"/>	<input type="checkbox"/>	<input type="checkbox"/>	<input type="checkbox"/>	<input type="checkbox"/>
	A	B	C																																																						
NAME :	_____	_____	_____																																																						
DESIGNATION :	_____	_____	_____																																																						
COMPANY :	_____	_____	_____																																																						
	Witness	Incident Reporter	LTA Personnel	Main Contractor's Personnel	Subcontractor's Personnel	Visitor	Public	Self Employed	Others : _____																																																
A	<input type="checkbox"/>	<input type="checkbox"/>	<input type="checkbox"/>	<input type="checkbox"/>	<input type="checkbox"/>	<input type="checkbox"/>	<input type="checkbox"/>	<input type="checkbox"/>	<input type="checkbox"/>																																																
B	<input type="checkbox"/>	<input type="checkbox"/>	<input type="checkbox"/>	<input type="checkbox"/>	<input type="checkbox"/>	<input type="checkbox"/>	<input type="checkbox"/>	<input type="checkbox"/>	<input type="checkbox"/>																																																
C	<input type="checkbox"/>	<input type="checkbox"/>	<input type="checkbox"/>	<input type="checkbox"/>	<input type="checkbox"/>	<input type="checkbox"/>	<input type="checkbox"/>	<input type="checkbox"/>	<input type="checkbox"/>																																																
PART D (Details of Damage to Property) <input type="checkbox"/> Main Contractor's property <input type="checkbox"/> LTA property <input type="checkbox"/> NOT APPLICABLE <input type="checkbox"/> Subcontractor's property <input type="checkbox"/> Public property <input type="checkbox"/> Others : _____																																																									
PART E (Details of Damage to Utilities) <input type="checkbox"/> Electrical <input type="checkbox"/> Gas <input type="checkbox"/> Sewer <input type="checkbox"/> Water <input type="checkbox"/> Traffic <input type="checkbox"/> NOT APPLICABLE <input type="checkbox"/> Multiple Utilities Damages <input type="checkbox"/> Telecoms <input type="checkbox"/> Others : _____																																																									

**LAND TRANSPORT AUTHORITY
SAFETY, HEALTH AND ENVIRONMENTAL
MANAGEMENT MANUAL**



INCIDENT OCCURRENCE REPORT FORM

PART F (Description of Incident)

WHAT HAPPENED ? HOW DID IT HAPPEN ? WHAT WERE THE CONSEQUENCES ? PLEASE ATTACH PHOTOGRAPHS AND SKETCHES.

Large empty text area with horizontal lines for incident description.

LAND TRANSPORT AUTHORITY SAFETY, HEALTH AND ENVIRONMENTAL MANAGEMENT MANUAL	
--	---

INCIDENT OCCURRENCE REPORT FORM

PART G (Causes of Incident)

(1) Direct Causes

(i) Unsafe Conditions

<input type="checkbox"/> Absence of safety means <input type="checkbox"/> Congestion / restricted action <input type="checkbox"/> Dressing / apparel hazard <input type="checkbox"/> Environmental hazard (gas / dust / smoke) <input type="checkbox"/> Floor surface hazards (slips / trips / falls) <input type="checkbox"/> Hazardous arrangement <input type="checkbox"/> High temperature hazard <input type="checkbox"/> Improper / faulty equipment <input type="checkbox"/> Inadequate guarding / protection / precaution <input type="checkbox"/> Inadequate illumination <input type="checkbox"/> Inadequate ventilation	<input type="checkbox"/> Inadequate warning system <input type="checkbox"/> Inadequate / improper PPE <input type="checkbox"/> Inclement weather conditions <input type="checkbox"/> Noise hazard <input type="checkbox"/> Poor housekeeping <input type="checkbox"/> Presence of fire / explosion hazard <input type="checkbox"/> Radiation hazard <input type="checkbox"/> Unknown ground conditions <input type="checkbox"/> Unsound structure <input type="checkbox"/> No unsafe condition
--	---

Remarks :

(ii) Unsafe Practice

<input type="checkbox"/> Disregard instructions <input type="checkbox"/> Driving / operating error <input type="checkbox"/> Failure to secure / warn <input type="checkbox"/> Horseplay <input type="checkbox"/> Improper use of fail to use PPE <input type="checkbox"/> Improper / unsafe lifting/carrying <input type="checkbox"/> Improper /unsafe use of equipment/materials <input type="checkbox"/> Improper / wrong use of bodypart <input type="checkbox"/> Intentional motive <input type="checkbox"/> Making safety devices inoperative	<input type="checkbox"/> Not paying attention <input type="checkbox"/> Operating / working at unsafe speed <input type="checkbox"/> Operating / working without authority <input type="checkbox"/> Taking improper / unsafe position or posture <input type="checkbox"/> Taking shortcuts <input type="checkbox"/> Tampering with equipment in motion <input type="checkbox"/> Under influence of alcohol/drugs <input type="checkbox"/> Unsafe loading / mixing / placing <input type="checkbox"/> Wrong working methods <input type="checkbox"/> No unsafe practice
---	--

Remarks :

(2) Root Causes

(i) Work Factors

<input type="checkbox"/> Inadequate equipment being used <input type="checkbox"/> Inadequate / lack of engineering <input type="checkbox"/> Inadequate / lack of maintenance <input type="checkbox"/> Inadequate / lack of supervision <input type="checkbox"/> Inadequate / lack or work procedures	<input type="checkbox"/> Lack of co-ordination / communication <input type="checkbox"/> Poor selection / placement <input type="checkbox"/> Pressure from external influence <input type="checkbox"/> Wear and tear <input type="checkbox"/> No work factors
--	--

Remarks :

**LAND TRANSPORT AUTHORITY
SAFETY, HEALTH AND ENVIRONMENTAL
MANAGEMENT MANUAL**



INCIDENT OCCURRENCE REPORT FORM

(ii) Human Factors

- | | |
|--|--|
| <input type="checkbox"/> Fatigue | <input type="checkbox"/> Lack of skill |
| <input type="checkbox"/> Foul play | <input type="checkbox"/> Lack of training |
| <input type="checkbox"/> Illness | <input type="checkbox"/> Needs conflicting with safety |
| <input type="checkbox"/> Improper assignment of personnel | <input type="checkbox"/> Not qualified |
| <input type="checkbox"/> Improper or lack of motivation / interest | <input type="checkbox"/> Unsafe attitude |
| <input type="checkbox"/> Inadequate capability | <input type="checkbox"/> No human factors |
| <input type="checkbox"/> Lack of knowledge | |

Remarks :

(3) Weakness of Safety Management System

- | | |
|--|--|
| <input type="checkbox"/> Safety policy | <input type="checkbox"/> Safe work practices |
| <input type="checkbox"/> Safety training | <input type="checkbox"/> Group meetings |
| <input type="checkbox"/> Incident investigation and analysis | <input type="checkbox"/> In-house safety rules and regulations |
| <input type="checkbox"/> Safety promotion | <input type="checkbox"/> Evaluation, selection and control of SC |
| <input type="checkbox"/> Safety inspections | <input type="checkbox"/> Maintenance regime for all machinery |
| <input type="checkbox"/> Hazard analysis | <input type="checkbox"/> Control of movement and use of hazardous substances and materials |
| <input type="checkbox"/> Emergency preparedness | <input type="checkbox"/> Not applicable |
| <input type="checkbox"/> Occupational health programs | |

Remarks :

PART H

RECOMMENDATION	ACTION TAKEN

**LAND TRANSPORT AUTHORITY
SAFETY, HEALTH AND ENVIRONMENTAL
MANAGEMENT MANUAL**



INCIDENT OCCURRENCE REPORT FORM

PART J (Details of Investigating Person)

NAME : _____

DESIGNATION : _____

COMPANY : _____

TEL : _____ **DATE** : _____ **SIGN** : _____

PART K (Reviewed By)

NAME : _____

DESIGNATION : _____

COMPANY : _____

TEL : _____ **DATE** : _____ **SIGN** : _____

PART L (Form Completed By)

NAME : _____

DESIGNATION : _____

COMPANY : _____

TEL : _____ **DATE** : _____ **SIGN** : _____

LAND TRANSPORT AUTHORITY SAFETY, HEALTH AND ENVIRONMENTAL MANAGEMENT MANUAL	
--	--

ENVIRONMENTAL INCIDENT OCCURRENCE REPORT FORM	LTA REF NO : _____
--	---------------------------

Incident Title

Name of Main Contractor: _____ Report Ref. No : _____

PART A (Type of Incident)

Water Pollution
 Transmission of Vector Borne Disease
 Vector Breeding
 Air Pollution
 Ecological Harm
 Land Pollution
 Noise Pollution
 Others: _____

PART B (Details of Incident)

PROJECT : _____ CONTRACT : _____
 EXACT LOCATION : _____
 OCCURRENCE DATE : _____ OCCURRENCE TIME : _____
 REPORTED DATE : _____ REPORTED TIME : _____
 COMPANY RESPONSIBLE FOR INCIDENT : _____

PART C (Persons involved in the Incident)

	A	B	C
NAME :	_____	_____	_____
DESIGNATION :	_____	_____	_____
COMPANY :	_____	_____	_____

Status (you may tick more than one) :

	Witness	Incident Reporter	LTA Personnel	Main Contractor's Personnel	Subcontractor's Personnel	Visitor	Public	Self Employed	Others : _____
A	<input type="checkbox"/>	<input type="checkbox"/>	<input type="checkbox"/>	<input type="checkbox"/>	<input type="checkbox"/>	<input type="checkbox"/>	<input type="checkbox"/>	<input type="checkbox"/>	<input type="checkbox"/>
B	<input type="checkbox"/>	<input type="checkbox"/>	<input type="checkbox"/>	<input type="checkbox"/>	<input type="checkbox"/>	<input type="checkbox"/>	<input type="checkbox"/>	<input type="checkbox"/>	<input type="checkbox"/>
C	<input type="checkbox"/>	<input type="checkbox"/>	<input type="checkbox"/>	<input type="checkbox"/>	<input type="checkbox"/>	<input type="checkbox"/>	<input type="checkbox"/>	<input type="checkbox"/>	<input type="checkbox"/>

LAND TRANSPORT AUTHORITY
SAFETY, HEALTH AND ENVIRONMENTAL
MANAGEMENT MANUAL



ENVIRONMENTAL INCIDENT OCCURRENCE REPORT FORM

PART D (Description of Incident)

**WHAT HAPPENED? HOW DID IT HAPPEN? WHAT WERE THE CONSEQUENCES? WHAT IS THE EXTEND OF THE POLLUTION?
PLEASE ATTACH PHOTOGRAPHS AND SKETCHES.**

LAND TRANSPORT AUTHORITY
SAFETY, HEALTH AND ENVIRONMENTAL
MANAGEMENT MANUAL



ENVIRONMENTAL INCIDENT OCCURRENCE REPORT FORM

PART E (Causes of Incident)

(1) Direct Causes

(i) Non-Complying Environmental Management Conditions

- | | |
|---|--|
| <input type="checkbox"/> Absence of mitigation measures | <input type="checkbox"/> Improper material storage |
| <input type="checkbox"/> Extreme weather conditions | <input type="checkbox"/> Poor housekeeping |
| <input type="checkbox"/> Faulty equipment | <input type="checkbox"/> Presence of food source |
| <input type="checkbox"/> Inadequate mitigation measures | <input type="checkbox"/> Other: _____ |

Remarks :

(ii) Non-Complying Environmental Management Practice

- | | |
|--|---|
| <input type="checkbox"/> Disregard instructions | <input type="checkbox"/> Not paying attention |
| <input type="checkbox"/> Failure to inform | <input type="checkbox"/> Operating/working without authority approval |
| <input type="checkbox"/> Improper mitigation measures | <input type="checkbox"/> Taking shortcuts |
| <input type="checkbox"/> Improper use of equipment/materials | <input type="checkbox"/> Wrong working methods |
| <input type="checkbox"/> Intentional motive | <input type="checkbox"/> Other: _____ |

Remarks :

(2) Root Causes

(i) Work Factors

- | | |
|---|--|
| <input type="checkbox"/> Inadequate equipment being used | <input type="checkbox"/> Lack of co-ordination / communication |
| <input type="checkbox"/> Inadequate / lack of engineering | <input type="checkbox"/> Poor selection / placement |
| <input type="checkbox"/> Inadequate / lack of maintenance | <input type="checkbox"/> Pressure from external influence |
| <input type="checkbox"/> Inadequate / lack of supervision | <input type="checkbox"/> Wear and tear |
| <input type="checkbox"/> Inadequate / lack of work procedures | <input type="checkbox"/> No work factors |

Remarks :

LAND TRANSPORT AUTHORITY
SAFETY, HEALTH AND ENVIRONMENTAL
MANAGEMENT MANUAL



ENVIRONMENTAL INCIDENT OCCURRENCE REPORT FORM

(ii) Human Factors

- | | |
|--|--|
| <input type="checkbox"/> Careless attitude | <input type="checkbox"/> Lack of skill |
| <input type="checkbox"/> Fatigue | <input type="checkbox"/> Lack of knowledge |
| <input type="checkbox"/> Foul play | <input type="checkbox"/> Lack of training |
| <input type="checkbox"/> Improper assignment of personnel | <input type="checkbox"/> Needs conflicting with environmental management |
| <input type="checkbox"/> Improper or lack of motivation/interest | <input type="checkbox"/> Not qualified |
| <input type="checkbox"/> Inadequate capability | <input type="checkbox"/> No human factors |

Remarks :

(3) Weakness of Environmental Management System

- | | |
|--|--|
| <input type="checkbox"/> Environmental policy | <input type="checkbox"/> Environmental work practices |
| <input type="checkbox"/> Environmental training | <input type="checkbox"/> Group meetings |
| <input type="checkbox"/> Incident investigation and analysis | <input type="checkbox"/> In-house environmental rules and regulations |
| <input type="checkbox"/> Environmental promotion | <input type="checkbox"/> Maintenance regime for machineries |
| <input type="checkbox"/> Environmental inspections | <input type="checkbox"/> Control of movement and use of hazardous substances and materials |
| <input type="checkbox"/> Environmental impact analysis | <input type="checkbox"/> Not applicable |
| <input type="checkbox"/> Emergency preparedness | |
| <input type="checkbox"/> Environmental management programme | |

Remarks :

PART F

RECOMMENDATION	ACTION TAKEN

LAND TRANSPORT AUTHORITY
SAFETY, HEALTH AND ENVIRONMENTAL
MANAGEMENT MANUAL



ENVIRONMENTAL INCIDENT OCCURRENCE REPORT FORM

PART G (Details of Investigating Person)

NAME : _____
DESIGNATION : _____
COMPANY : _____
TEL : _____ DATE : _____ SIGN : _____

PART H (Reviewed By)

NAME : _____
DESIGNATION : _____
COMPANY : _____
TEL : _____ DATE : _____ SIGN : _____

PART I (Form Completed By)

NAME : _____
DESIGNATION : _____
COMPANY : _____
TEL : _____ DATE : _____ SIGN : _____

SCHEDULED CHARGES – FOR LOST OF BODY PARTS

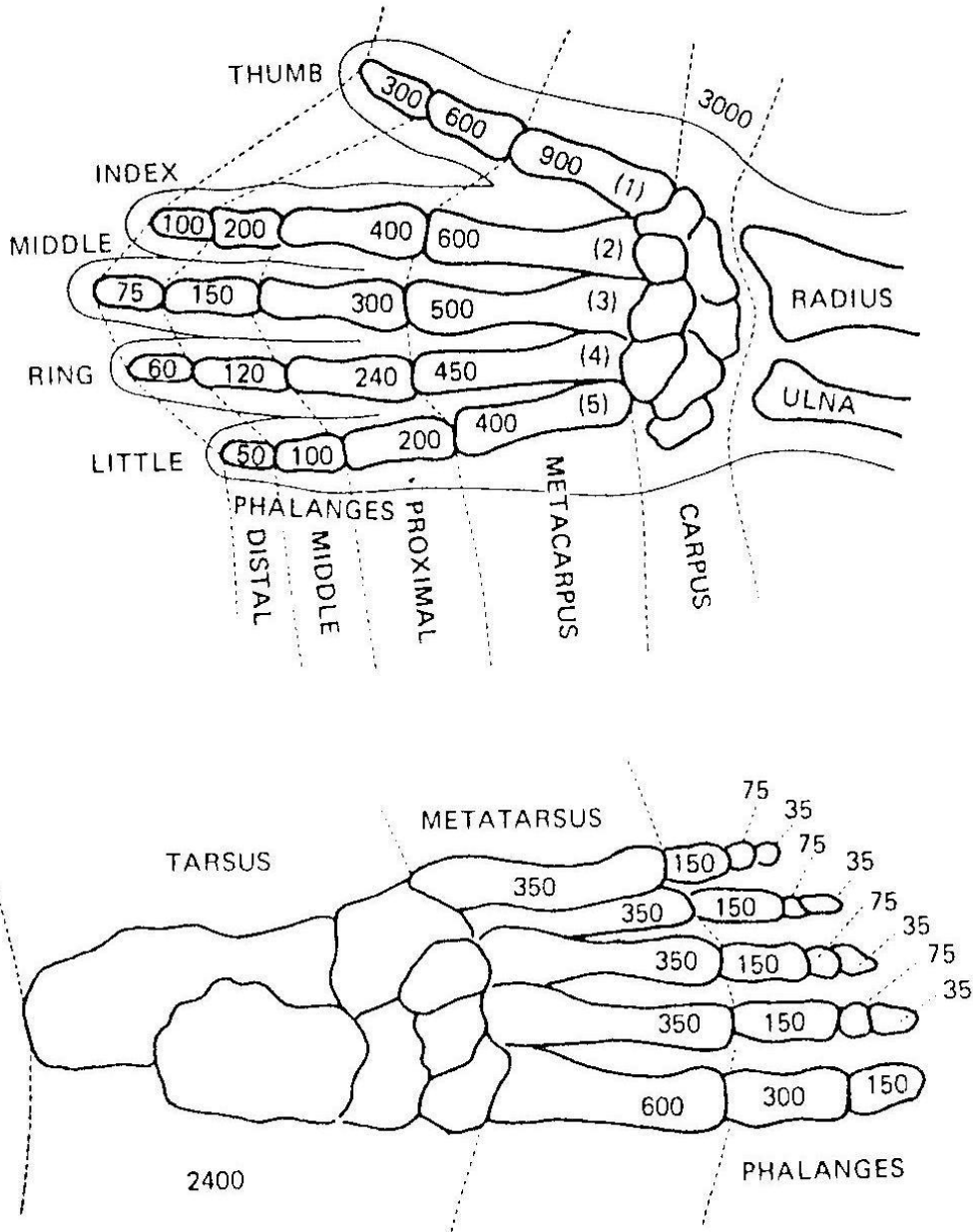

Notes:

Numbers on the bones are the mandays lost involving part or all of the bone.

Source: American National Standard Institute (ANSI) Z16 – Method of Recording and Measuring Work Injury Experience

SCHEDULED CHARGES – FOR FATALITY, LOST OF BODY PARTS OR FUNCTIONS

Description	Mandays Lost
Arm: <ul style="list-style-type: none"> • Any point above elbow, including shoulder joint • Any point above wrist and at or below elbow 	4500 3600
Leg: <ul style="list-style-type: none"> • Any point above knee • Any point above ankle and at or below knee 	4500 3000
Impairment of Function: <ul style="list-style-type: none"> • One eye (loss of sight), whether or not there is sight in the other eye • Both eyes (loss of sight), in one accident • One ear (complete industrial loss of hearing), whether or not there is hearing in the other ear • Both ears (complete industrial loss of hearing), in one accident • Unrepaired hernia (for repaired hernia, use actual mandays lost) 	1800 6000 600 3000 50
Fatal or permanent total disability	6000

Source: American National Standard Institute (ANSI) Z16 – Method of Recording and Measuring Work Injury Experience

CONTRACTOR'S MONTHLY SAFETY, HEALTH & ENVIRONMENT (SHE) REPORT

The report shall follow the format given:

1. **Project Profile**

A brief description of the project e.g. Contract Title, Contract No., Award Date, Completion Date etc.

2. **Executive Summary**

To give a brief summary of the site SHE events such as any educational, promotional and enforcement activities.

Attachments

The following items shall be attached. Nil return to be indicated if the section is not applicable

- (a) Contractor's Monthly Incident / Accident Return Summary.
- (b) Contractor's Monthly Accident Statistics Report Form.
- (c) Summary of Accident & Incident.
- (d) SHE Organisation chart.
- (e) Register of Contractor's SHE Training Record
- (f) List of Safety Time-out
- (g) Summary of SHE Promotional Activities
- (h) Summary of Sub-contractor SHE Evaluation
- (i) Register of Plant, Equipment and Tool
- (j) Register of Hazardous Substance & Chemical
- (k) Summary of Emergency Drill
- (l) Summary of SHE Audit
- (m) Listing of SHE Award.
- (n) SHE Initiatives and Best Practices
- (o) Summary of visits by MOM, NEA, PUB or Other Authorities
- (p) Summary of Public Feedback or Complaint
- (q) List of Environmental Management Plans

PS-A-52

- (r) Summary of noise readings for the month for night works with reasons for exceeding the limits
- (s) Summary of TSS Monitoring Results for the month
- (t) Monthly ECM Inspection Report conducted by QECP. (refer to ATTACHMENT A-13)

ATTACHMENT A – Monthly Incident / Accident Return Summary

CONTRACTOR'S MONTHLY INCIDENT/ACCIDENT RETURN SUMMARY		
PROJECT TITLE : _____		
CONTRACT : _____		
CONTRACTOR : _____		
TOTAL NO OF EMPLOYEES (including Sub-contractors) : _____		
REPORTING MONTH : _____		YEAR : _____
DESCRIPTION	NO OF CASES (this month)	NO OF CASES (this year to date)
MOM Reportable Accident (>3 Days MC)		
MOM Reportable Accident (LD or <3 Days MC)		
Occupational Disease (MOM Reportable)		
Dangerous Occurrence (MOM Reportable)		
Dangerous Incident (non-MOM Reportable)		
Near Miss		
Utility Damage		
Property Damage		
Fire		
Road / Traffic Related		
Security Violation		
Ordance Related		
Crime		
Environmental Incident		
Stop Work Order		
Safety Non-Compliance		
Environmental Non-Compliance		
Other Occurence:		
FORM COMPLETED BY : _____		
DESIGNATION : _____		
SIGNATURE : _____		
DATE : _____		

ATTACHMENT B – Monthly Accident Statistic Report Form

CONTRACTOR’S MONTHLY ACCIDENT STATISTICS REPORT FORM

PROJECT : _____ **CONTRACT NO :** _____ **YEAR :** _____

	(A) AVG. NO. OF WORKERS ONLY	(B) TOTAL MANHOURS WORKED FOR WORKERS ONLY	(C) AVG. NO. OF ENGINEERS & ABOVE	(D) TOTAL MANHOURS WORKED FOR ENGINEERS & ABOVE	(E) AVG. NO. OF ENTIRE WORKFORCE (A+C)	(F) TOTAL MANHOURS WORKED FOR ENTIRE WORKFORCE (B+D)	(G) MANHOURS WORKED PER WORKER (F/E)	(H) NO. OF FATAL CASES	(I) NO. OF MOM REPORTABLE ACCIDENTS EXCLUDING (H) (MANDAYS LOST > 3 DAYS OR HOSPITALISED ≥ 24 HRS)	(J) TOTAL MANDAYS LOST IN (H) + (I)	(K) NO. OF MOM REPORTABLE ACCIDENTS (MANDAYS LOST ≤ 3 DAYS OR Light duty)	(L) TOTAL MANDAYS LOST IN (K)	(M) AFR (H) + (I) / (F) X 1,000,000	(N) SR (J) / (F) X 1,000,000	(O) NO OF DANGEROUS OCCURRENCE (MOM REPORTABLE)	(P) REMARKS
JAN																
FEB																
MAR																
APR																
MAY																
JUN																
JUL																
AUG																
SEP																
OCT																
NOV																
DEC																
END OF YEAR ACCUMULATIVE																

FORM COMPLETED BY : _____ DESIGNATION : _____ SIGN : _____ DATE : _____

ATTACHMENT C – Summary of Accident & Incident

LIST OF ACCIDENTS SINCE START OF PROJECT							
No.	Details of Accident		Loss Time		Root Cause		Preventive Measure
	Occurrence Date / Time	Brief Description	MC	Light Duty	Work Factor	Human Factor	
1							
2							
3							

LIST OF INCIDENTS SINCE START OF PROJECT (EXCLUDE NEAR MISS)						
No.	Details of Incident			Root Cause		Preventive Measure
	Occurrence Date / Time	Brief Description	Type of Incident	Work Factor	Human Factor	
1						
2						
3						

Near Miss Reported vs Number of Accident & Incident by Work Activity

ATTACHMENT D – Updated SHE Organisation Chart

<p>WSHM (if applicable)</p>	
<p>WSHO / ECO</p>	
<p>WSH Co- ordinator</p>	
<p>WSH Supervisor</p>	

ATTACHMENT E – Register of Contractor’s SHE Training Record
 Training matrix indicating completed (C), scheduled (S) and On-going (O).

MANAGEMENT LEVEL				General Safety						Functional						Emergency Response		
				Risk Management	LTA Construction Safety Management	Const. Safety for PM	ISO 45000 Internal Audit			Management of Hazardous Substance	Managing WAH	SMO Course						
No.	Name	Designation	Other Roles															
1																		
2																		
3																		

SUPERVISORY LEVEL				General Safety		Functional								Emergency Response		
				Risk Management	LTA Construction Safety Management	WAH for Sup	Lifting Sup	CS Sup	Scaffold Sup	Formwork Sup	Management of Hazardous Material	WAH Assessor	CS Assessor	OFA	Fire Fighting	Height Rescue
No.	Name	Designation	Other Roles													
1																
2																
3																

WORKING LEVEL				General Safety		Functional										Emergency Response	
				CSOC		WAH for Workers	Rigger & Signalman	Work in CS	Scaffold Erector	Scissors Lift Operator	Boom Lift Operator	Excavator Operator	Traffic Controller	Handling Hazardous Substance			OFA
No.	Name	Designation	Other Roles														
1																	
2																	
3																	

ATTACHMENT F – List of Safety Time-out
Contractor to plan for Safety Time-out for the year.

No.	Planned for the Year 2021		Actual		
	Month	Topic	Date Conducted	No. of participants	Remarks
1					
2					
3					

ATTACHMENT G – Summary of SHE Promotional Activity

Contractor to plan for **high impact** SHE promotional activities for the year and to conduct two SHE Campaigns per year.

No.	Planned for the Year 2021		Actual		
	Month	Promotional Activity	Date Conducted	No. of participants	Remarks
1					
2					
3					

ATTACHMENT H – Summary of Sub-contractor SHE Evaluation

To use the Monthly Sub-contractor SHE Evaluation Form

No.	Sub-Con	Trade	BizSAFE Level	Jan	Feb	Mar	Apr	May	Jun	Jul	Aug	Sep	Oct	Nov	Dec
1															
2															
3															

Score Guide			
Excellent	Good	Satisfactory	Non-Performer
≥76	≥ 70 < 76	≥ 65 < 70	< 65

ATTACHMENT I – Register of Plant, Equipment and Tool

PLANT/EQUIPMENT/TOOL REQUIRING STATUTORY INSPECTION								
No.	Owner	ID No.	Description	DOI	DOE*	Maintenance Date	Next Maintenance Date	Remarks
1								
2								
3								

* DOE is 6 months after DOI for lifting equipment such as LM, LG, LA, LP etc.

PLANT/EQUIPMENT/TOOL NOT REQUIRING STATUTORY INSPECTION							
No.	Owner	Serial No	Description	Maintenance Date	Next Maintenance Date	Remarks	
1							
2							
3							

ATTACHMENT J – Register of Hazardous Substance & Chemical

No.	Owner	Chemical Name	Key Hazards	Quantity	Storage Location	Incoming Date	SDS Review Date	Remarks
1								
2								
3								

ATTACHMENT K – Summary of Emergency Drill
 Contractor to plan for emergency drills for the year.

No.	Planned for the Year 2021		Actual				
	Type of Drill	Planned Month	Date Conducted	Description	Location	No. of Person Involved	Remarks
	<i>Inhouse Drill</i>						
	Table-Top Exercise with SCDF						
	Joint Drill with SCDF						

Drill KPI

Type of Drill	Frequency
In-house	Quarterly
TTX with SCDF	Half yearly
Emergency drill with SCDF	Yearly
Evacuation time	< 10mins

ATTACHMENT L – Summary of SHE Audit
Contractor to plan for SHE audits for the year.

No.	Planned for the Year 2021		Actual		
	Planned Month	Type of Audit	Date Conducted	Auditor	Remarks
1					
2					
3					

ATTACHMENT M – List of SHE Award Since Beginning of Project

No.	Date	Type of Award	Awarding Body	Remarks
1				
2				
3				

ATTACHMENT N – SHE Initiative and Best Practice

No.	Date Implemented	SHE Initiative & Best Practice	Benefit	Picture
1				
2				
3				

ATTACHMENT O – Summary of Visit by MOM, NEA, PUB or Other Authorities

Outcome such as fines, warning notices, demerit points, etc. to be recorded.

No.	Date	Visitor	Finding*	Follow Up Action*	Outcome*
1					
2					
3					

* A “Nil” reply is required accordingly.

ATTACHMENT P – Summary of Public Feedback or Complaint

No.	Type of Feedback/Complaints	Total Number of Feedback/Complaints for Jan 2021	Investigation and Corrective Action(s) Taken for High Profile Case
1	Safety & Health Related		
2	Noise Pollution		
3	Vector		
4	Earth Control Measures		
5	Others (e.g. Air Pollution, Waste Management, etc)		

ATTACHMENT Q – List of Environmental Management Plans

No.	Environmental Management Plan	Revision Number	Date of Last Review	Remarks
1				
2				
3				

ATTACHMENT R – Summary of Noise Readings for the Month for **Night Works Only**Noise Meter Website and Login Details: www.noiselynx.com

Applicable Noise Limits: Residential Buildings Located Less than 150m from the Construction Site

Noise Meter at 123 Road					
No.	Date	Leq 5min exceeded for the following time period? (Y/N)			Reason(s) for Exceeding the Limits
		7pm – 10pm	10pm – 12am	12am –7am	
1					
2					
3					

ATTACHMENT S – Summary of TSS Monitoring Results for the Month

TSS Meter Website and Login Details:

TSS Meter at ECM Plant 01

****Insert TSS graph**

No.	Date which TSS Limit Exceeded	Reason (s) for Exceeding the Limits

Data Logger Report

PS-A-77

Contractor shall download the full data log (raw data) and keep the data for their record. Raw data are not to be submitted in this monthly report.

The following documents are to be attached together with this report.

- a. Lifting machine certificate
- b. Summary page of the data logger monthly report originally generated by the data logger

DETAIL OF LIFTING MACHINE (LM) & DATA LOGGER (DL)	
LM Certificate No.	
LM Brand & Model No.	
Type & Description of LM	
LM Date of Manufacture*	
Owner of LM	
Contractor Using the LM	
DL Brand	
DL Serial No.	
DL Report Generated Date	

* No lifting machine over 15 years old (based on date of manufacture) shall be operated in any LTA Site.

SUMMARY OF OVERLOAD & LIMIT SWITCH BYPASS OPERATION

OVERLOAD		BYPASS	
Total No. of Overload		Total No. of Bypass	
Total Time of Overload		No. of Overload Limit Switch Bypass	
Maximum Overload Time		No. of Over-Hoist Limit Switch Bypass	
Maximum Overload Moment (%)		No. of Over-Derrick Limit Switch Bypass	

DETAILS OF OVERLOAD OPERATION

No.	Date	Time	Part Line (Main / Aux)	Boom Angle (deg)	Operating Radius (m)	SWL (T)	Actual Load Lifted (T)	Load Moment (%)	Remarks
1									

DETAILS OF LIMIT SWITCH BYPASS OPERATION

No.	Date	Time	Part Line (Main / Aux)	Boom Angle (deg)	Operating Radius (m)	SWL (T)	Actual Load Lifted (T)	Load Moment (%)	Bypass*			Remarks
									OL	OH	OD	
1												

Bypass*

OL – Overload; OH – Over-hoist; OD – Over-derrick

Sample of Lifting Machine certificate

FORM B
 MINISTRY OF MANPOWER, SINGAPORE
 WORKPLACE SAFETY AND HEALTH ACT 2006
 WORKPLACE SAFETY AND HEALTH (REGISTRATION AND OTHER
 SERVICES FEES AND FORMS) REGULATIONS
 CERTIFICATE OF TEST/THOROUGH VISUAL EXAMINATION
 OF LIFTING EQUIPMENT (LE)*

LE Registration No. :	LM [REDACTED]
UEN of Owner. :	[REDACTED]
Workplace No. :	

Owner of Lifting Equipment	Factory Occupier and Location of Lifting Equipment
[REDACTED]	At various locations

Particulars of Lifting Equipment	
Type and Description of Lifting Equipment	611 Mobile Crane - Crawler Mounted Variable Boom Length Type Classification Code : 611
Brand Name	: SENNEBOGEN 683R Distinctive No. ** : 683.5.238
Country of Origin	: GERMANY Date of Manufacture : 2014
Source of Power	: Diesel Engine First Registration Date : 22/04/2014
Max. Safe Working Load	: 18600 kg Max. Boom Length/Span : 42.00 m
Owners' Reference/Vehicle Registration No.	: Length of Fly Jib/Extension : 1.0 m

Particulars of Last Load Test						
Date of Load Test	: 15/11/2017			Max Test Load : 25000 kg		
	(1)	(2)	(3)	(4)	(5)	(6)
Radius (m) :	7.0	27.0	9.0	25.0		
Test Load (kg) :	9000	5200	25000	6000		
Safe Working Load (kg) :	7200	4000	18600	4800		

Comments/Observations

[REDACTED]

3) Load Radius Indicator and safe devices are in proper working order.
 4) Data logger (Brand: Hirschmann, SN: 100417) installed on 18/04/2017.

I certify that on 15/11/2017 the lifting equipment described in this certificate was examined thoroughly by me, as far as its construction permits, and this is a true report of my examinations.

I further certify that the lifting equipment complies in all respects with the requirements pertaining to lifting equipment as stipulated in the Workplace Safety and Health (General Provisions) Regulations, and all other regulations made thereunder and is safe for use.

Expiry Date of Certificate	Date of Print of Certificate	Authorised Examiner's Name	Signature of Authorised Examiner
14/11/2018	25/11/2017	[REDACTED]	[REDACTED]



* Lifting Equipment means Lifting Gear, Lifting Appliance, Lifting Machine, Lift and Hoist as defined under the Workplace Safety and Health (General Provisions) Regulations.
 ** Distinctive Number refers to the Identification Number/Serial Number assigned to the equipment by the manufacturer.



PS-A-80

Sample of Data Logger

CREATED 05 Feb 2018

Period

01 Jan 2018 - 31 Jan 2018

Daily Operation History

MODEL CRE1800-1F	SERIAL No. JC04-02166	CRANE ID	CUSTOMER
---------------------	--------------------------	----------	----------

PERIOD TOTAL	OPERATION HOURS	Max Load		ML Bypass		OVER LOAD	FUEL USED(L)	TOTAL	HOUR METER	
		(%)	(t)	OVERLOAD	HOOK				BOOM	
	362	124.0	35.4	0	0	0	1		10396	0

DATE	OPERATION																								OPERATION HOURS	Max Load		OVERLOAD	ML Bypass		OVERLOAD	FUEL USED(L)	FUEL REMAIN(%)			
	0	1	2	3	4	5	6	7	8	9	10	11	12	13	14	15	16	17	18	19	20	21	22	23		(%)	(t)		HOOK	BOOM						
01 Jan 2018																										20:00	90.6	28.8								46
02 Jan 2018																										8:01	94.7	35.4								75
03 Jan 2018																										21:10	124.0	25.4				1				77
04 Jan 2018																										13:07	70.1	22.6								59
05 Jan 2018																										5:59	60.7	13.0								51
06 Jan 2018																										5:58	48.1	12.7								42
07 Jan 2018																										6:14	60.9	13.1								39
08 Jan 2018																										6:03	74.8	21.3								19
09 Jan 2018																										12:26	66.4	21.6								59
10 Jan 2018																										17:41	73.8	23.4								100
11 Jan 2018																										6:40	93.3	12.6								83
12 Jan 2018																										0:26	95.6	12.9								76
13 Jan 2018																										5:40	102.0	20.2								66
14 Jan 2018																										4:08	44.5	12.6								64
15 Jan 2018																										1:52	6.3	1.6								62
16 Jan 2018																										12:32	96.3	22.9								48
17 Jan 2018																										11:54	64.2	20.6								25
18 Jan 2018																										5:01	80.0	19.5								14
19 Jan 2018																										6:13	59.2	18.6								67
20 Jan 2018																										5:50	67.4	22.6								60
21 Jan 2018																										0:00										60
22 Jan 2018																										13:24	72.6	23.2								37
23 Jan 2018																										21:40	79.6	25.6								100
24 Jan 2018																										22:21	83.5	26.9								42
25 Jan 2018																										22:56	88.3	27.9								47
26 Jan 2018																										23:21	85.6	28.5								47
27 Jan 2018																										18:43	73.3	24.7								4
28 Jan 2018																										5:45	57.6	19.2								51
29 Jan 2018																										12:21	68.8	23.0								37
30 Jan 2018																										21:14	84.9	27.1								52
31 Jan 2018																										21:32	86.2	27.4								62

PS-A-81

CREATED 01 Nov 2015

Period 01 Oct 2019 ~ 31 Oct 2019

Monthly Operation History

MODEL	SERIAL No.	CRANE ID	CUSTOMER
BM800HD-2F	GD04-03011		

YEAR TOTAL									
OPERATION N_DAYS	OPERATION HOURS	Max Load		M/L Bypass			OVERLOAD	FUEL USED(L)	OVERLOAD RATE(%)
		(%)	(t)	OVERLOAD	HOOK	BOOM			
27	200	140.0	9.1	10	11	10	0	125.10%	

TOTAL	HOUR METER
	12010

MONTH	OPERATION																															OPERATION DAYS	OPERATION HOURS	Max Load		M/L Bypass			OVERLOAD	FUEL USED(L)
	1	2	3	4	5	6	7	8	9	10	11	12	13	14	15	16	17	18	19	20	21	22	23	24	25	26	27	28	29	30	31			(%)	(t)	OVERLOAD	HOOK	BOOM		
2019/10	[Bar chart showing daily operation hours for October 2019]																															27	200:09	140.0	9.1	10	11	10		

Sample of Data Logger monthly summary page

PS-A-82

DATA LOGGER REPORT
scx800 7026
From 01 May 2017 To 31 May 2017

THERE IS NO OVERLOAD TO DISPLAY

DATA LOGGER REPORT
scx800 7026
From 01 May 2017 To 31 May 2017

THERE IS NO BYPASS TO DISPLAY

DATA LOGGER REPORT
scx800 7026
From 01 May 2017 To 31 May 2017

SUMMARY OF ATE:

Total no. of ails

7

No	Date Time	Duty	No. Parts	Operator
1	04 May 2017 03:17:00 PM	0019	4	00000
2	04 May 2017 03:18:42 PM	0019	4	00000
3	04 May 2017 03:21:40 PM	0019	4	00000
4	04 May 2017 03:21:40 PM	0019	4	00000
5	04 May 2017 03:26:36 PM	0019	4	00000
6	04 May 2017 03:34:37 PM	0019	4	00000
7	07 May 2017 01:56:40 PM	0000	1	00000

RISK ASSESSMENT GUIDELINES

1. The risk assessment process normally requires baseline information on appropriate control measures, derived from a number to which the Contractor is expected to make reference:
 - Industry standards and codes of practice
 - Experience of individuals
 - Accidents/incidents records
 - Knowledge of processes/activities
2. It is essential that these risk assessments are carried out by teams of appropriately experienced and competent people.

3. General Risk Assessment Procedure**3.1 Breaking Down the Activity into its Constituent Elements**

To breakdown an activity the following considerations must be taken into account

- Take into account the scope of the work process
- A step by step breakdown of the work activity
- The persons involved in the work
- The duration of work
- The type of equipment/machinery
- The type of material handled
- The work environment

3.2 Identifying the Hazards associated with each step

Consider what could go wrong at each step in order to identify the types of hazards in the work activity

- The hazards a person is exposed to at every step of the work activity, eg. falling from height, material falling from height, slipping
- The hazards associated in operating the equipment / machinery
- The hazards associated in handling the material
- The hazards relating to the work environment

3.3 Evaluate Accident Frequency

3.3.1 This is based on the judgement of those carrying out the assessment and where possible supported by LTA past projects statistics

3.3.2 **TABLE 1:** Likelihood (Frequency) of Occurrence

No	Likelihood (Frequency)	Rating	Description
1	Almost Certain	5	Likely to occur within the next month. Probability: >90% chance of occurring (Likely to occur 12 times or more per year)
2	Likely	4	Likely to occur between 1 to 2 months Probability: 60% to 90% chance of occurring (Likely to occur 4 times or more per year)
3	Possible	3	Likely to occur between 3 months to 1 year Probability: 30% to 60% chance of occurring (Likely to occur once a year)
4	Unlikely	2	Likely to occur between 1 year to 3 years Probability: 10% to 30% chance of occurring (Likely to occur once in 5- year project period)
5	Very Unlikely	1	Likely to occur beyond 3 years Probability: <10% chance of occurring (Unlikely, but may exceptionally occur)

3.4 Evaluate Accident Severity

3.4.1 An estimation of the likely consequences of the hazardous element occurring in terms of injury or loss.

3.4.2 **TABLE 2:** Magnitude of Impact (Severity)

No	Consequence (Severity)	Rating	Description(*)
1	Extreme (Catastrophic)	5	Workplace Safety <ul style="list-style-type: none"> Fatality or multiple fatalities and/or events which triggers Commission of Inquiry under the WSH Act; and/or Loss of whole production for greater than 3 days and/or Total loss in excess of \$1 million.

No	Consequence (Severity)	Rating	Description(*)
2	Major	4	Workplace Safety <ul style="list-style-type: none"> Total permanent incapacity or Dangerous Occurrences classified under the WSH Act; and/or Damaged to works or plants causing delays of up to 3 days; and/or Total loss in excess of \$250,000 but up to \$1 million.
3	Moderate	3	Workplace Safety <ul style="list-style-type: none"> MOM reportable accident (More than 3 days MC) or Occupational Diseases; and/or Damage to works or plants causing delays of up to 1 day; and/or, Total loss in excess of \$25,000 but up to \$250,000.
4	Minor	2	Workplace Safety <ul style="list-style-type: none"> Minor injuries, MOM reportable accident (3 days or lesser MC or light duties); and/or Damage to works or plants does not cause significant delays; and/or Total loss of up to \$25,000.
5	Insignificant	1	Workplace Safety <ul style="list-style-type: none"> First aid cases (e.g. minor scratches) Damage to works or plants that causes insignificant delays; and/or Total loss of up to \$1,000.

Note: (*) If more than one of the descriptions occurs, the severity rating would be increased to the next higher level.

3.5 Evaluate the Risk Matrix

3.5.1 TABLE 3: Risk Prioritisation Matrix

Risk Category			Magnitude of Impact (Severity)				
			1	2	3	4	5
			Insignificant	Minor	Moderate	Major	Extreme
Likelihood of Occurrence (Frequency)	5	Almost Certain	B	B	A	A	A
	4	Likely	C	B	B	A	A
	3	Possible	D	C	B	B	A
	2	Unlikely	D	D	C	C	B
	1	Very Unlikely	D	D	C	C	C

3.5.2 The definitions of the risk indices determined from the Risk Index Matrix are presented in the Table 4.

3.5.3 **TABLE 4:** Definition of Risk Index

Risk Index	Description	Definition
A (Very High)	Intolerable	Risk shall be reduced by whatever means possible.
B (High)	Undesirable	Risk shall only be accepted if further risk reduction is not practicable.
C (Medium)	Tolerable	Risk shall be accepted subject to demonstration that the level of risk is as low as reasonably practicable.
D (Low)	Acceptable	Risk is acceptable.

3.6 Propose *control measures* to reduce the risk to an acceptable level

Examples of such control measures are emergency stop devices found in certain equipment, use of skilled tradesmen such as a lifting supervisor for lifting operations.

3.7 Repeat Step 3 to 5 to re-evaluate the *residual risk* index with the control measures in place.

This step is essential in monitoring the reduction of the risk after the implementation of control measures.

3.8 A pro-forma for safety and health hazard log which can be used to record risk assessments is attached in Table 5.

SAFETY AND HEALTH HAZARD LOG

ACTIVITY-BASED RISK ASSESSMENT FORM												
Company :				Activity/Process :				Location of work :				
Conducted By (RA team members) :	Name	Designation	Date	Reviewed By :	Name	Designation	Date	Approved By :	Name	Designation	Date	
Last Review Date :				Next Review Date :								

S/No	Description of Work Activity	Hazards Identified	Risk	Existing Control Measures	Initial Risk Index			Additional Control Measures	Residual Risk Index			Risk Owner (Action Officer)		
					F	S	R		F	S	R	Name	Designation	Follow-up Period

Note: F – Frequency of Occurrence; S – Severity of Hazard; R – Risk Index

**METHOD STATEMENT
SUBMISSION REQUIREMENTS***

The checklist below serves as a guideline for Contractors in the submitting of method statement to the Engineer.

This checklist is to be duly completed and submitted together with the method statement.

Method of Work

1. Date, time and duration of works.
2. Site plans / schematic diagrams.
3. Preparatory works.
4. Mode of transportation.
5. Actual work / installation / delivery.
6. Use of special equipment / machine.
7. Lifting operations (including lifting radius).
8. Inspection / supervision.
9. Temporary Traffic Diversion / control.
10. Liaising / interfacing with other Contractors.

Yes	N/A	Remarks

Manpower

1. Organisational / hierarchy chart.
2. List of manpower.
3. Evidence of Site Safety Induction Training.
4. Evidence of competency training (e.g. Trade Cert., Crane Operator's License etc.).

Yes	N/A	Remarks

Health & Safety

1. Hazard analysis.
2. Preventive measures.
3. Safe Work Procedures.
4. Permit To Work system.
5. Hand Protection Measures.
6. List of Personal Protective Equipment.
7. Material Safety Data Sheet.
8. First aid / Firefighting equipment.
9. Tool Box Meetings.
10. References to legislations / Code of Practice.

Yes	N/A	Remarks

- Refers to work / activities which are potentially hazardous.

ATTACHMENT A-4
(Page 2 of 2)

Tools & Equipment

1. List of approved tools / equipment.
2. 110 volts for hand-held tools.
3. Relevant statutory certifications (e.g. LM Cert., LG Cert., PE Cert. etc.).

Yes	N/A	Remarks

Materials

1. List of approved materials.
2. Schematic diagrams.
3. Safety Data Sheet.

Yes	N/A	Remarks

Emergency Plan

1. Emergency evacuation plan.
2. Emergency reporting procedures.
3. List of essential personnel with contact numbers.
4. Contingency plan.

Yes	N/A	Remarks

Others

1. Method statement reviewed & endorsed by WSHO

Yes	N/A	Remarks

Remarks:

Submitted By: _____
 Name / Designation / Contact No.

_____ Date

_____ Contractor / Contract No.

ESS ASSESSMENT FORM ON CONTRACTORS
(2021 Version)

Year		Contract No.	
Month		Contractor	
Contract Title			

SECTION A - ACCIDENT STATISTICS			
	Item	Max Score	Actual Score
*Cumulative Accident Frequency Rate (AFR)	(a) 0	5	
	(b) > 0 but < 1.0	4	
	(c) ≥ 1.0 but < 2.0	3	
	(d) ≥ 2.0 but < 3.5	2	
	(e) ≥ 3.5 but < 4.5	1	
	(f) ≥ 4.5	0	
*Cumulative Accident Severity Rate (ASR)	(a) 0	5	
	(b) > 0 but < 50	4	
	(c) ≥ 50 but < 100	3	
	(d) ≥ 100 but < 150	2	
	(e) ≥ 150 but < 300	1	
	(f) ≥ 300	0	
SUB-TOTAL		10	

*** AFR and SR will be reinstated to 0 if a contractor manages to avoid any accident for an 18 month period**

SECTION B - SITE SAFETY PRACTICES AND CONDITIONS			
Item		Max Score	Actual Score
Public Complaints on construction noise, traffic diversions, etc	(a) 0 valid public complaints	5	
	(b) 1 to 2 valid public complaints	3	
	(c) 3 to 4 valid public complaints	1	
	(d) 5 and above valid public complaints	0	
	(e) 100% addressed within required timescale	2	
	(f) 80% addressed within required timescale	1	
	(g) 60% addressed within required timescale	0	
Safety and Environmental Inspections* (PGI conducted by LTA)	(a) Zero identified substandard conditions / practices per safety and environmental conducted by LTA	28 (Max)	
	(b) Deduct for each item per safety and environmental inspection requiring rectification within 24 hrs	- 3 (per item)	
	(c) Deduct for each item per safety and environmental inspection requiring rectification within 3 days	- 2 (per item)	
	(d) Deduct for each item per safety and environmental inspection requiring rectification within 7 days	- 1 (per item)	
	(e) 100% of identified substandard conditions / practices at safety and environmental inspection rectified within required timescale	5	
	(f) 80% of identified substandard conditions / practices at safety and environmental inspection rectified within required timescale	3	
	(g) Below 80% of identified substandard conditions / practices at safety and environmental inspection rectified within required timescale	0	
SUB-TOTAL		40	

Footnote:-

1. If there are zero valid complaints then scores should not be assigned for rectification but Section B prorated accordingly.
2. If there are zero substandard conditions / practices, then scores should not be assigned for rectification but Section B prorated accordingly.
3. Scores for the number of substandard conditions / practices should be based on the average scores obtained for the safety inspections conducted during the month.

SECTION C - ENVIRONMENTAL, SAFETY AND SECURITY (ESS) MANAGEMENT			
	Item	Max Score	Actual Score
Effective Implementation of ESS Management	(a) Occupational Safety, e.g., Permit-To-Work Systems, Safety Promotion, Safety Training, Control of Subcontractors, Emergency Drills, PPE, Housekeeping, etc. (b) Occupational Health, e.g., Hygiene Hearing / Respiratory protection etc.	10	
	(c) Site Security	5	
	(d) Environmental Management (see attached Annex for breakdown on areas of assessment and their respective weightage on Environmental Management)	20	
Safety, Health and Environmental Work Practices	(a) Implemented new and effective ESS or Sustainability measures / initiatives beyond legal and contractual requirements eg. BBS, Total WSH etc.	5	
	(b) Method Statement & Hazard analysis conducted on every work operation, accepted by LTA	10	
	(c) Adherence to safe work procedures as detailed in method statement and hazard analysis during execution of the work operation.		
SUB-TOTAL		50	

ATTACHMENT A-5
(Page 4 of 9)

ITEM	MAX SCORE	ACTUAL SCORE
Accident Statistics	10	
Site Safety Conditions and Practices	40	
Environmental, Safety and Security Management	50	
SUB-TOTAL	100	
SECTION D - DEDUCTIONS (when applicable)		
(a) Fatality / Permanent Total Disablement Case <i>(50 marks for each case)</i>		
(b) Dangerous Occurrence (DO) as defined in Workplace Safety and Health Act <i>(50 marks for each occurrence)</i>		
(c) Amputations / Cases with ≥ 20 days medical leave <i>(50 marks for each case)</i>		
(d) Stop Work Orders by MOM, NEA or PUB (excluding Fatal/D.O. cases) <i>(50 marks for each case)</i>		
(e) Accident cases with medical leave ≥ 7 but < 20 days medical leave <i>(30 marks for each case)</i>		
(f) Accident cases with > 14 days light duty <i>(5 marks for each case)</i>		
(g) Incidents stated in Annex for Deduction <i>(marks deducted for incidents are as stated in the Annex)</i>		
(h) Fines issued by MOM, NEA or PUB <i>(For MOM related fines, 5 marks for each case. For environmental related fines, an increase in 5 marks deduction for every case of environmental non-compliance received within the calendar year i.e. 5 marks deduction for 1st non-compliance received, 10 marks deduction for 2nd non-compliance received etc)</i>		
(i) Fail to provide immediate notification on occurrence of accident or incident <i>[5 marks for 1st case, 10 marks for 2nd case and 20 marks for 3rd and subsequent cases (accumulated throughout contract period)]</i>		
Utility Damages		
(i) Results in disruption of service / system > 24 hours, or exceed \$100,000 in repair costs <i>(10 marks for each case)</i>		
(ii) Results in disruption of service / system > 4 hours, or exceed \$10,000 in repair costs <i>(6 marks for each case)</i>		
(iii) Results in disruption of service / system or exceed \$5,000 in repair costs <i>(4 marks for each case)</i>		
FINAL SCORE		

Note: System refers to a set of parts working together as parts of a mechanism or an interconnecting network to form a complex whole in order to work as intended.

Completed By Assessor:

Endorsed By Moderator:

Name: _____

Name: _____

Designation: _____

Designation: _____

Date: _____

Date: _____

Signature: _____

Signature: _____

* A copy of this duly completed form to be sent to LTA CSEP Division

ANNEX for Deduction (DEDUCTIONS FOR NON-STANDARD ITEMS)	Marks to be deducted
(a) Collision / runaway of any locomotives / rolling stocks	20 marks for each case
(b) Derail of any locomotives / rolling stocks	5 marks for each case
End of List	

ANNEX OF ESS ASSESSMENT FORM ON CONTRACTORS

Year		Contract No.	
Month		Contractor	
Contract Title			

Environmental Management			
	ITEMS	Max Score	Actual Score
Earth Control Measures	ECM Plan: Reviewed by Qualified Erosion Control Professional (QECP) and updated according to the phase of work.	3	
	Implementation of Plan: ECM facilities implemented according to plan	4	
	Maintenance: Adequate maintenance of ECM facilities	4	
	Compliance with Regulations: TSS of discharge \leq 50mg/L	5	
Solid Waste Management	Inspection: Inspections conducted frequently by QECP and ECMO / ECO	4	
	Site Provision: Adequate management of wastes	2	
	Waste Segregation: Reusable and recyclable wastes are recovered	1	
Water Pollution Control	Site Observation: Minimal littering observed within the site and in any public area	2	
	Site Provision: Provision for containment of pollutive substances	4	
	Site Provision: Management of wastewater with well-maintained facilities	5	
	Site Observation: No sign of pollutive spillages / leakages	3	
	Site Observation: Regular checks on disposal / treated effluent to ensure compliance to regulations	3	

Environmental Management			
ITEMS		Max Score	Actual Score
Noise Management* (Not applicable if exempted by NEA)	Noise Management Plan: Reviewed by acoustic consultant and updated according to the phase of work.	2	
	Implementation of Plan: Noise mitigation and monitoring measures implemented according to plan	5	
	Work scheduling: No noisy works at night and during no-work period unless approved by LTA	3	
	Deployment: Adequate deployment of sound-reduced machinery and equipment	6	
	Maintenance: Adequate maintenance of noise mitigation measures and monitoring devices	4	
	Compliance with Regulations: Noise levels rarely exceed permissible noise limits	3	
	Stakeholder Engagement: Proactive public relation efforts observed	2	
Vector Control	Vector Control Plan: Plan updated according to the phase of work	3	
	Skilled Resource: Sufficient trained manpower to carry out search and destroy efforts in accordance to schedule	2	
	Source Reduction: Efforts for rodent and fly control	2	
	Source Reduction: Efforts to prevent collection of water	5	
	Remediation Action: Adequate usage of vector control chemicals	5	
	Maintenance: Gravitraps deployed and maintained for monitoring of mosquito	2	
	Compliance with Regulations: No vector breeding observed by LTA	2	
	Inspection: Inspections conducted frequently by Vector Control Operator (VCO) and in-house vector control team	4	

Environmental Management			
ITEMS		Max Score	Actual Score
Air Pollution Control	Site Provision: Adequate provision for dust arresting measures at source	4	
	Maintenance: Adequate maintenance of machinery and equipment	2	
	Site Observation: No black smoke emission from machinery	2	
	Site Observation: Minimal dust emission from exposed earth, transferring and transporting of spoil, etc.	2	
FINAL SCORE		75 100 (With Noise Consideration)	
SCORE converted to 20% (Converted score to be assigned onto Section C item D of ESS ASSESSMENT FORM (under Environmental Management))		Actual Score x 20%	
		Max Possible Score	

LIFTING OPERATIONS

1 General

- 1.1 The Contractor shall be responsible for ensuring that all lifting operations carried out on site and any rental cranes brought onto site are done so with minimal risk of injury to persons including members of the public or damage to property.
- 1.2 Effective control must be exercised at all stages of a lifting operation through the deployment of a competent lifting supervisor, a qualified signaller, a registered crane operator and sufficiently trained riggers. Contractor may combine the role of rigger and signaller for Routine Lifting operations (refer to Code of Practice on Safe Lifting Operations in the Workplaces for definition), subjected to conduct of a detailed risk assessment and provision of adequate control measures before allowing this work arrangement.
- 1.3 All lifting machines, lifting appliances and lifting gears used on site must be suitable for the task, used within their rated safe load capacity and must be in good condition.
- 1.4 The Contractor is to submit a weekly list to the Engineer of all cranes permanently deployed on site detailing their ownership, make, identification number, maximum Safe Working Load (SWL) and the corresponding radius, lifting Machine (LM) certificate number and date of expiry.
- 1.5 The Contractor shall ensure that any lorry loader on Site is only used for the delivery to Site and collection / removal from Site of materials within its rated lifting capacity, and not for lowering any materials into a trench or excavation, or for raising any materials to a higher level. However, transporting materials or plant / machinery around Site may be permitted if the lorry loader has been tested on the site by an Authorised Examiner.

Contractor may appeal to the Engineer for use of lorry loader to support other construction activities provided:

- a) use of mobile crane is not possible due to space constraints;
- b) detailed risk assessment has been conducted and adequate control measures are implemented for this work arrangement; and
- c) lorry loader is equipped with a manufacturer approved stability control system compliant with EN12999:2011 or equivalent internationally recognised Standards

- d) the stability control system should include the Rated Capacity Limiter. This monitors the position of the stabilisers and limits the lifting capacity according to the stabiliser's deployment
 - e) the stability control system should calculate in real time the permissible working range for any slewing angle of the boom system and for any stabiliser situation. It should stop the crane at non-working range to prevent any overloading or toppling
- 1.6 All lorry loaders entering into the Site shall have an interlocking system installed to prevent a lorry loader from moving off before its articulated boom is fully retracted back to its "stored" position.
- 1.7 The boom of any lorry loader shall not be used for holding down materials or equipment and it shall be retracted to its "stored" position before it moves off.
- 1.8 Loading / Unloading operations involving lorry loader shall take place over the side of the main body and not in an arc over either the front or rear of the chassis, in accordance with safe working practices.
- 1.9 No excavator shall be used as a lifting machine on site unless it is originally designed and manufactured to also function as a lifting machine and comply with all MOM stipulated requirements. For excavators used as LMs, the operator has to attend and complete the additional training on use of excavator as a LM.
- 1.10 The Contractor shall ensure that a Permit to Lift system is operated to evaluate all routine planned lifting operations generically and all heavy or one-off lifting operations individually. This latter category of lifting operations includes the raising / lowering of items of plant in excavations. Lifting plans shall be submitted to the Engineer for acceptance in advance of any heavy or one-off lifting operations.
- 1.11 Lifting Supervisors and Riggers shall don brown and red safety helmets respectively. Riggers and signalmen shall wear reflective vest with identification tags.
- 1.12 The crane operator is to ensure that the outriggers are fully extended, and any adjustments made to the jacks to level the crane before the lifting operation commences. All lifting machine with outriggers, including lorry loader with articulating arm, shall have steel plates of minimum dimension 1m by 1m by 25mm placed under all the outriggers deployed for a lifting operation unless that crane is entirely sited on hard standing such as a reinforced concrete surface, with no void underneath. Pieces of timber are not to be used.
- 1.13 Lifting of machineries and / or equipment shall be done as per manufacturer's recommendations.

- 1.14 All works using lorry loaders for lifting shall have their outriggers fully extended. For lifting works that require the lorry loader to extend the outriggers partially due to site constraints (eg. working along the public roads), it shall have a manufacturer approved Stability Control System, compliant with EN12999:2011 or equivalent internationally recognised Standards, that is able to detect the limits of the safe working load and provide automatic cut-off upon detection of overloading, based on the different configurations of outriggers extension.

2 Lifting Machinery

- 2.1 This term includes, but is not limited to, lattice jibbed crawler mounted cranes, hydraulic variable jib mobile cranes, rail mounted gantry cranes, mobile and fixed tower cranes.
- 2.2 The Contractor shall ensure that before any lifting machine, including lorry loaders with articulating arm used for delivery to site, is brought into use on site the labels on all controls, the details on the safe working load radius chart and any other safety related notices in the cab or on the body of the lifting machine shall be written in English as well as in a language comprehensible to the crane operator.
- 2.3 Before being taken into use on site for the first time, in the case of a lifting machine which undergoes assembly on site, or following the substantial alteration of any type of lifting machine such as the jacking up of a tower crane, the lifting machine must be load tested by an Authorised Examiner and subsequently examined every six months whether it is owned by the Contractor, one of his Subcontractors or by a crane rental company. The Contractor shall make arrangements for the examination by an Authorised Examiner before the expiry date so that there is continuity of cover of LM certificate.
- 2.4 The Contractor shall ensure that no lifting operation shall be carried out on site using the auxiliary hook of a mobile crane unless the SWL of this is shown on the LM Certificate in addition to that of the main hook block, and that this SWL is not exceeded during operation.
- 2.5 The Contractor shall ensure that both the Lifting Supervisor and the crane operator are able to understand the working load chart.
- 2.6 No lifting machine over 15 years old (based on date of manufacture) shall be operated on any LTA Site.

- 2.7 Cranes fitted with a Load Radius Indicator (LRI) shall sound an audible alarm in the crane cab if its SWL is exceeded on either the main or the auxiliary hook. A second alarm connected to the LRI, shall be fitted external to the cab and shall emit a signal of a sufficient volume to make it audible above the ambient site noise levels during working hours. Visual warning shall also be provided externally to indicate safe working range and overload conditions.
- 2.8 LRI shall be fitted with a limiting device, which disables the crane from continuing with any lifting operation under overload conditions. Once disabled, the device should only permit the crane to return to the safe working range. The device shall be tamper proof, with no over-ride to disable it, and shall be maintained in good working order. In instances where there is a bypass switch for the LRI, it shall be secured by a lock and the key kept with the lifting supervisor.
- 2.9 The LRI shall be calibrated every six (6)monthly by an approved agency and verified by the Authorised Examiner during his six (6)monthly inspections. Records of LRI calibration shall be submitted to the Engineer. If there is any doubt as to the accuracy of the LRI the machine shall be taken out of use until the calibration is carried out to the satisfaction of the Engineer.
- 2.10 If the crane is down rated by the Authorised Examiner during his six (6) monthly inspections then the LRI shall also be calibrated and a new capacity chart should be drawn up and posted in the crane cab. The Authorised Examiner shall highlight the above details on the LM certificate.
- 2.11 A lifting machine shall not be used for any unsafe operation that may affect its overall integrity or stability.
- 2.12 The Contractor shall ensure that lifting machine capable of travelling / tracking and slewing, such as a mobile crane, shall be operated in such a manner that there is always an unobstructed passageway in excess of 600mm between it and any other fixture or machinery.
- 2.13 To address the risk of trapping or crushing of persons working at or near the tracks of a gantry crane, an unobstructed passageway of at least 750mm in width on each side of each rail, shall be maintained parallel to and extending the entire length of the tracks upon which any gantry crane is operated. This requirement is clearly stated in clause 15.3.1 of SS497:2011 and clause 2.11.11 of SS567:2011. Authorised Examiners are reminded to check the compliance of the above requirement during the commissioning of the gantry crane as well as the subsequent periodic statutory examinations.
- 2.14 All lifting machines that operate on LTA sites shall be installed with a rear view camera that enables the operator to have a clear view of the back of the machine.

- 2.15 The use of fly jib on any lifting machines shall be subjected to the approval of the Engineer.
- 2.16 The concurrent use of the crane's main and auxiliary hooks during lifting shall be prohibited.
- 2.17 The Contractor shall engage a specialist contractor with a wire rope inspection device for checking of wire ropes of all service cranes and diaphragm wall machines. The required inspection frequency for the wire ropes shall be based on manufacturer/supplier's recommendation.
- 2.18 The Contractor shall ensure that weatherproof camera(s) with real-time recording capabilities, enabled optical and digital zoom and linked to monitors in the operator's cabin shall be installed on the crane hook or jib head to effectively assist the crane operator. There shall also capabilities to enable the crane operator to see people and load in dark places such as under shade or night time.

3 Crane Data Logger

- 3.1 All cranes without manufacturer fitted data loggers operating on site shall be retrofitted with data loggers approved by the Engineer.
- 3.2 All cranes with either manufacturer-fitted or retrofitted data loggers shall have their data loggers enabled when operating on sites.
- 3.3 The data recorded by the data loggers shall be monitored, downloaded and interpreted by the Contractor on a monthly basis and submit electronic copy (e-copy to the Engineer as part of the SHE monthly report. The Engineer may at his discretion require the Contractor to download the data when he deems necessary.
- 3.4 The contractor shall ensure that the data logger is calibrated by an authorised personnel from the data logger manufacturer when the crane is mobilised on site for the first time and subsequently on a six (6) monthly basis. A calibration certificate shall be submitted to the Engineer.
- 3.5 The data logger shall have the following capabilities:
- (a) Detection of overloading, over-hoisting and, over-derricking, as well as bypassing of limit switches;
 - (b) Continuous recording of critical crane operational parameters;
 - (c) Data downloading feature;
 - (d) Data security and anti-tampering features;
 - (e) Real time stamping;
 - (f) Report generation feature; and
 - (g) Real time warning and alert feature.

- 3.6 The data logger shall be able to perform continuous record of the following crane operational parameters whenever the crane is in operation:
- (a) Date, time and duration of the crane's operational hours, (i.e. from the time engine starts till engine shuts);
 - (b) All unsafe lifting operations which includes overloading, over-hoisting, and over-derricking, as well as bypassing of limit switches;
 - (c) Load Moment Indication;
 - (d) Weight of load lifted;
 - (e) Crane operating capacity (Safe Working Load);
 - (f) Slewing angle;
 - (g) Boom angle;
 - (h) Boom length;
 - (i) Crane operating radius;
 - (j) Number of part lines indicating hook configuration (main or auxiliary hook);
 - (k) Crane operational hours since installation;
 - (l) Faults / settings display and
 - (m) Position of jib or boom.
- 3.7 The data logger shall have real-time alert function and shall be monitored by Lifting Engineer or the Contractor's safety team on a monthly basis. The Real-time alerts shall send to the Contractor's safety team, Lifting Engineer and the Project Manager.

4 Mobilisation and Demobilisation

- 4.1 The Contractor shall carry out a risk assessment and establish a Safe Work Procedure for the mobilisation and demobilisation process that is specific to the model of the lifting machine being used on Site. The risk assessment and SWP shall take into account factors such as the limitations of the lifting machinery as stated in the manufacturer's operation manual, physical Site constraints and weather conditions.
- 4.2 The Contractor shall ensure that the ramps used for the mobilisation and demobilisation of heavy machinery comply with the requirements stated in the manufacturer's operation manual and should not be narrower than the width of the machinery's tracks.
- 4.3 The Contractor shall consult the lifting machinery's manufacturer on the appropriate and safe method for mobilisation and demobilisation should critical factors such as angle of slope, direction of travel etc. that may limit the lifting machinery's function are not specified, or the proposed mobilisation and demobilisation method differs from the operation manual.
- 4.4 The Contractor, as and when necessary, may fabricate a ramp that is PE designed and it should be wide enough to accommodate the width of the machinery's tracks.

5 Temporary Rental Cranes

- 5.1 At least 24 hours before any rental mobile / crawler mounted crane is brought onto site the Contractor must submit to the Engineer:
- (a) The lifting plan for the operation to be carried out.
 - (b) A copy of the current LM certificate for the crane.
 - (c) A copy of the crane operator's MOM registration.
 - (d) The name of the Lifting Supervisor will be responsible for it, and
 - (e) A record of any repairs carried out since the last LM certificate was issued.
- 5.2 The Contractor shall ensure that, as far as practicable, rental cranes entering site are manned with the same operator, who shall undergo site induction training before commencing operation. If for any reason the crane rental company sends a substitute operator he shall also undergo site induction training.
- 5.3 Before any crane is accepted onto site for use it must undergo a thorough mechanical check by the Crane Maintenance Supervisor, and the findings verified by the Contractor's WSH Officer.

6 Erection of Cranes on Site

- 6.1 The Contractor shall engage only Approved Crane Contractors to install, alter, repair or dismantle any parts of a mobile or tower crane which affects the lifting capacity of that crane. A copy of the MOM approval letter shall be retained with the crane erector doing the repair.
- 6.2 The minimum strength of the team who erects / dismantles any tower crane must be one (1) approved crane erector and five (5) trained assistants, and for a mobile crane is one (1) approved crane erector and two (2) assistants.

7 Lifting Gear (LG) / Lifting Appliance (LA)

- 7.1 The Contractor shall ensure that every LG / LA brought onto site, including that accompanying rental cranes, lorry loaders, excavators, cement buckets, air receivers, skips, welding sets etc. has a valid LG / LA certificate and clearly marked with its SWL. All LG / LA shall be inspected by an Authorised Examiner once every six months.
- 7.2 The Contractor shall ensure that LG / LA is not loaded beyond its SWL and this includes multi leg chain slings being used at variable angles.

- 7.3 The Contractor shall ensure that LG / LA is not used for any purpose other than the raising or lowering of a load. If an excluded activity takes place, such as the use of a lifting chain for towing an item of plant / machinery, then the Contractor shall ensure that this item of LG / LA is no longer used for any further lifting operations.
- 7.4 If an item of lifting gear is inadvertently subjected to a force exceeding that of which it is designed to experience when lifting an object at its SWL then the Contractor shall ensure that it is taken out of use.
- 7.5 The Contractor shall implement an inspection programme to thoroughly check all LG / LA by a Lifting Supervisor prior to its first use on site and thereafter on a monthly basis. A monthly colour coding system shall be adopted. Defective LG / LA shall be discarded immediately.
- 7.6 When not in use the Contractor shall ensure that all items of LG / LA are stored in a rack sheltered from the weather and maintained regularly. Should any LG / LA be exposed to a corrosive material e.g. wet concrete, it must be washed off afterwards and re-greased.
- 7.7 The Contractor shall ensure all the lifting lugs for any equipment used on site shall be designed by a Professional Engineer (PE). Non-destructive Testing (NDT) shall be conducted on lifting lugs on heavy equipment/machinery or on any equipment/machinery as directed by the Engineer before use on site.
- 7.8 All wire rope lifting gears shall be installed with thimbles to protect the wire rope from wear and tear. No “soft eye” LG shall be allowed on site.

8 Lifting Supervisors (LS)

- 8.1 The Contractor shall ensure that a sufficient number of qualified LS are employed on site, whether by himself or by his sub-contractors, to give adequate cover for all lifting operations carried out both by day and by night including loading / unloading. The LS may supervise and co-ordinate two Routine Lifting operation when the operations are side by side and within close proximity with no obstacle, blind spot or entrapment of point during manoeuvring of the load or lifting equipment. In addition, when lifting operations are carried out near public areas, the contractor shall station at least (1) one additional worker to assist the signaller to manage flow of pedestrians.
- 8.2 The contractor shall install warning devices/ flags at least (2) two metres above top of hoarding that are alongside roads, footpaths and adjacent structure.

- 8.3 The LS shall supervise and co-ordinate all lifting operations under his/her charge. The LS shall familiarise himself with the load chart of each crane for which he is responsible and has identified himself to the operator of each such crane as being the only individual whose instructions concerning any lifting operation are to be followed. This includes the positioning of the crane prior to the lift as well as the slinging of the load.
- 8.4 Before any lifting operation involving a mobile or crawler mounted crane is carried out the LS must satisfy himself that the crane is positioned suitably close to the load and its destination to ensure that the operation can be carried out at the safest appropriate radius.
- 8.5 The LS shall ensure that the load is safely rigged, and a tag line is attached if appropriate, before signalling to the crane operator to start the lift. The LS is responsible for the load until it is safely resting at the intended destination either by taking control of the operation himself for non-routine lifts or, for routine lifting operations, by thoroughly briefing the crane operator, riggers and signaller on the safe procedure to be followed.
- 8.6 The Contractor shall put measures in place to discipline any person other than the dedicated LS, or one acting under his close supervision, who attempts to take control of any lifting operation other than those of a routine nature where a safe lifting procedure has already been established.

9 Crane Maintenance Supervisor

- 9.1 The Contractor shall appoint a full time Crane Maintenance Supervisor certified competent by a MOM approved crane supplier company to attend to all the mechanical aspects of operations involving lifting machines, lifting equipment and lifting gear on site.
- 9.2 The Crane Maintenance Supervisor shall carry out periodic planned maintenance on all lifting machines to ensure that they are in good working order.
- 9.3 The Crane Maintenance Supervisor shall be responsible for ensuring that each crane operator is competent to carry out the checks necessary before the crane is taken into use on any day / shift, and shall carry out his own weekly thorough check of all cranes on site.

10 Crane Operator

- 10.1 The Contractor shall engage only qualified crane operators with at least five (5) years of experience in operating similar types of cranes with no record of crane toppling / failure or barred from any site previously for a crane related incident.

- 10.2 The crane operator shall enter the date, types of maintenance carried out and any malfunction of the crane in a checklist or logbook. He shall not operate the crane until any such defect is rectified, and the crane's use is authorised by his LS.
- 10.3 All cranes shall be checked by its operator at the start of any day / shift using a checklist written in English and in a language comprehensible to the operator. Copies of the checklist together with LM certificate, operator certificate, and permits should be retained in the crane cabin for verification.

11 Lifting Engineer

- 11.1 To ensure that day to day lifting operations are monitored at an appropriate level of management, the Contractor shall appoint a Lifting Engineer from his staff, preferably his site engineer with a minimum of five (5) years site experience to oversee the activities of the various lifting supervisors on site. All issues concerning safety of any lifting operations shall be referred to this appointed Lifting Engineer for a final decision.
- 11.2 The Contractor shall ensure the appointed Lifting Engineers had successfully completed the "Appointed Persons – Lifting Operations Course" conducted by the Institution of Engineers Singapore (IES), or equivalent course approved by the Engineer.
- 11.3 The Contractor shall ensure that a lifting plan is drawn up and agreed with his appointed engineer responsible for lifting operations before any lifting operation is started. The engineer shall verify that the LS, the crane operator, the signaller and the riggers understand the part they have to play in ensuring that it is carried out safely. The lifting plan shall be forwarded to the Engineer for acceptance.
- 11.4 The Contractor shall ensure that weight of load is conspicuously marked on the load/equipment.
- 11.5 The Contractor shall ensure that crane access routes and working areas are designed by a Professional Engineer (PE) supported by ground evaluation and calculations incorporating a suitable safety factor. The PE shall provide layout plans that highlight any potential danger areas to avoid and indicate access routes and safe working areas for the types of mobile cranes to be used. A valid Certificate of Supervision (COS), ensuring that the deployment location(s) have been prepared in accordance with the design, shall be available.
- 11.6 The lifting engineer is responsible for checking that the proposed location of the crane for the lifting operation is sufficiently compacted to bear safely the force exerted by the crane, taking into consideration the proposed load to be lifted, and any additional forces exerted by the crane slewing or derricking.

- 11.7 The Contractor shall put in place a system for inspecting and upgrading the route over which a crawler mounted / mobile crane is to transit when it is being moved on site before any proposed lifting operation to ensure stability of the crane whilst travelling. Inspections must be conducted at least once a week or after inclement weather. The records of the inspections must be properly documented. This procedure shall also be followed when it is proposed that a crane transits carrying a load.
- 11.8 The Contractor's lifting engineer shall certify in writing, at least once a day that the crane access routes will support the force exerted by each crane and any load it may be carrying. The appointed engineer is to make an entry on a form designed for that purpose, sign it and hand it to the operator to keep in his cab before any crane is transited. Crane access checks shall be repeated after inclement weather as appropriate.

SITE TRANSPORT**1. GENERAL**

- 1.1. All vehicles driven on Site shall be maintained in roadworthy condition and be registered with the appropriate authority in accordance with the Road Traffic Act. Each driver of these vehicles shall hold a valid driving licence authorising him to drive that class of vehicle. Such vehicles include, but are not limited to cement lorries; pick-up and flat bed trucks; lorry loaders with articulating arms; and rough terrain forklifts.
- 1.2. Transportation of personnel on flat bed trucks, cranes, forklifts, dumpers and similar vehicles not designed to carry passengers is prohibited.
- 1.3. Personnel shall preferably be transported by buses. Where pick-up trucks, lorries or similar are used to transport workers, such transportation arrangement shall comply with prevailing legislative requirements. Free-standing chairs shall not be used as seating. All passengers must be seated at all times that the vehicle is in motion and shall not have any part of their body outside the vehicle. No more persons shall be carried in the cab of any vehicle than the number for which it is licensed.
- 1.4. An appropriate speed limit shall be set and enforced on site.
- 1.5. The Contractor shall appoint banksman to control reversing vehicles and congested machinery movement. The banksman shall wear a high visibility vest clearly marked "Traffic Controller" or similar and trained in the standard hand signals and always standing to the side of the driver's cab, not to the rear of the vehicle.
- 1.6. Any routes on the Site where headroom is restricted shall have appropriate warning signs posted at the approach to warn of such restriction.
- 1.7. The Contractor shall ensure that the drivers of all delivery vehicles to Site and those removing materials from Site, wear appropriate PPE including, but not limited to, safety footwear and safety helmets at all times that they are outside the cabs of their vehicles.
- 1.8. The Contractor shall ensure that there is daily co-ordination of the movement of mobile plant and vehicles on Site to minimize the potential for an incident.
- 1.9. All Site access roads used by mobile plant / vehicles shall be constructed of hard standing and suitable for its intended purpose.

- 1.10. No unauthorised parking shall be permitted on the Site anywhere other than at the designated parking area. Only cars bearing the Contractor's permit shall be allowed to park there, and those of authorised visitors.
- 1.11. Site plant / vehicles shall be parked at designated locations only so that they do not cause obstructions to Site traffic.
- 1.12. Consideration shall be given at all times to the safety of the road users and gates should be positioned so that they minimise the additional risk to traffic at such locations as road junctions, bends etc.
- 1.13. A clear line of sight shall be maintained for all drivers of vehicles using the road, taking into consideration the speed limit of that road and the position of existing street furniture and trees / vegetation, to maximise the warning distance of approach.
- 1.14. If deemed necessary by the Engineer suitable mirrors shall be positioned at these points to enhance vision of traffic movement both on the roadway and on entering / leaving the Site.
- 1.15. Where the Site gates lead directly off a public street an effective method of controlling vehicles entering / leaving the Site shall be employed. This shall be manned by workers who have been trained in traffic control and are identifiable with high visibility vests bearing the wording "Traffic Controller". They should adopt recognisable hand signals and advice should be sought from the Traffic Police if necessary.
- 1.16. If deemed necessary by the Engineer a traffic lane may be coned off to allow for safe deceleration.
- 1.17. During the hours of darkness floodlighting of these Site entrances shall be provided to enhance visibility of such traffic controllers, but care must be taken that these lights do not dazzle any on-coming traffic or pedestrians or cause a nuisance to neighbouring residents. The traffic controllers should utilise handheld light batons or traffic controller gloves incorporating reflective material.
- 1.18. Warning signs in compliance with the Code of Practice for Traffic Control at Work Zone shall be conspicuously displayed at appropriate distances before such gates into the Site as to give all drivers a clear understanding of the traffic hazard ahead.
- 1.19. If vehicles entering / leaving the Site have to cross a public footpath or pavement then a traffic controller must be deployed to control pedestrians as well as road traffic. Suitable warning signs should be deployed to alert pedestrians to possible traffic movement across the footpath.

- 1.20. Truck Mounted Attenuator (TMA) shall be deployed for works on road where legal speed limit is 70km/hr and above regardless of any advisory speed limit imposed on that road.

2. SPILLAGES ON ROADS

- 2.1. A paved truck wash bay for washing vehicles leaving the worksite onto a roadway shall be provided and maintained at each vehicular egress point before commencement of works on Site. Each truck wash bay design must be approved by the Public Utilities Board (PUB) as part of the Earth Control Measures (ECM) Plan before it can be constructed on site.
- 2.2. Washwater from the wash bays shall be directed into a water treatment plant for treatment.
- 2.3. Preventative measures shall be taken to limit the incidence of earth droppings from earth moving vehicles. In the event that any earth dropping occurs onto a public road / drain, such earth shall be removed and the roads / drains washed by the Contractor at his own expense to the satisfaction of the Engineer.
- 2.4. The contractor shall assign personnel and establish a system of checks to ensure that all vehicles and trucks leaving the worksite do not have the potential to litter the roads due to its wheels or transportation materials.
- 2.5. Where it is foreseeable that water may drain out from a load of soft marine clay or similar transported wet materials that will contaminate the road surface, the Contractor shall ensure that specially designed and constructed watertight trucks are used to transport these materials.
- 2.6. All cement mixer trucks servicing LTA sites must have a containment system or a flap installed to prevent spillage of cement. Please refer to schematic drawing and photographs below for the installation of the flap.

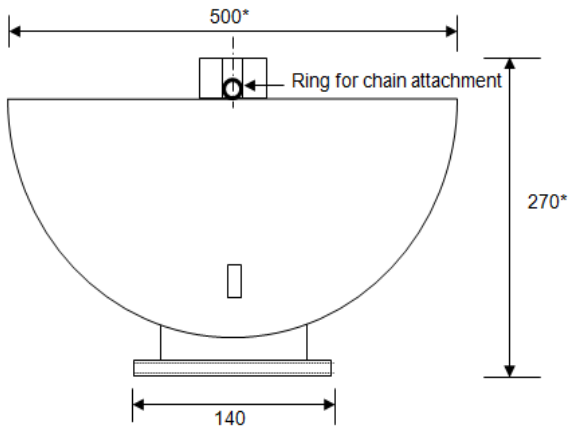

Section of Cover

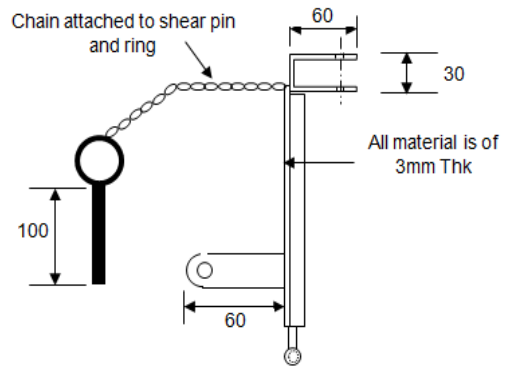

Elevation of Cover

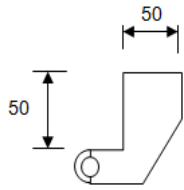

Details of bracket for cover

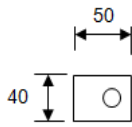

Details of Locking piece

* Dimensions varies depending on chute cover size

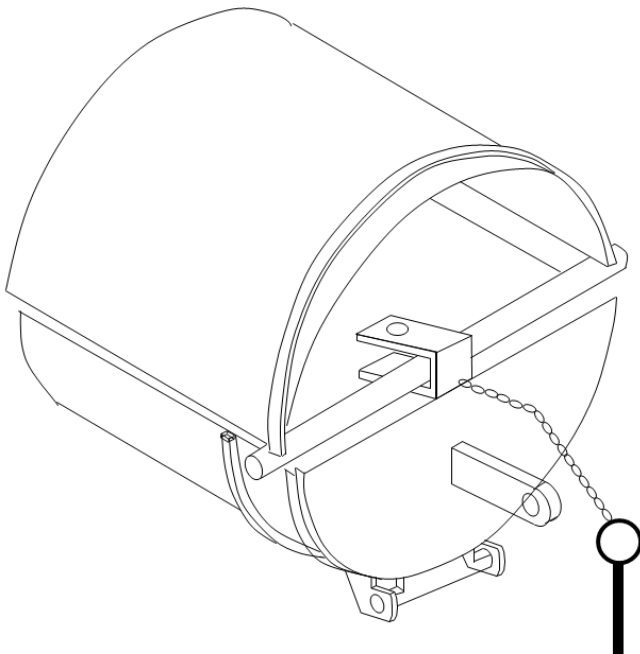

Isometric view of concrete cover with chute



Pin plate at the rear for securing the cover when opened



Pin to secure when closed



SITE SECURITY**1 GENERAL**

- 1.1 The Contractor is responsible for the security of the sites, works areas, material storage areas, site offices, facilities and the Works.
- 1.2 Security for the Site and the works shall be maintained throughout the duration of the Contract or the extended period as provided in the Particular Specification.
- 1.3 The Contractor is to provide a detailed Security Plan which includes security proposals for the various phases of the construction of the Works.
- 1.4 The security for the various phases of the Works shall include the set up phase, temporary works phase, structural works phase, E&M works and architectural works phase as well as the completion phase.
- 1.5 For each phase, the Contractor shall detail the security measures, facilities, guards and patrols to be implemented.
- 1.6 Within two (2) months or other specified period from the award of the Contract, the Contractor shall submit a fully detailed Security Plan detailing the Contractor's proposed security measures and facilities he intends to implement throughout the Contract duration. The Security Plan shall include but not limited to the followings:
- (a) Method of securing all site and works areas; offices and facilities etc.;
 - (b) The security facilities to be set up and its locations;
 - (c) Lightings, alarms, communication equipment, cameras, surveillance equipment etc.;
 - (d) Layout and site plans;
 - (e) Personnel, manpower and the organisation chart;
 - (f) Guards and patrols, numbers, locations and frequency;
 - (g) Security for various phases or stages of the Works;
 - (h) Controls to be implemented for access by authorised personnel / contractors / construction equipment / Plant / vehicles / materials;
 - (i) Control of access points for visitors and their vehicles entering the Site, issue of entry permits and maintaining records for every visitor and vehicle into the Site, including their stated purpose;
 - (k) Monthly review and reports;

- (l) Incident report and review;
- (m) Audits; and
- (n) Others.

- 1.7 The plan shall include a central security post/ office manned at all times by a competent uniformed supervising security guard and an assistant from a licensed Security Agency at an agreed location. It shall be possible to communicate between each of the satellite security posts/office and the central security post/office.
- 1.8 The Contractor shall update the Security Plan regularly and when the Works enters a new phase to ensure that the Site, facilities, and Works are adequately and sufficiently protected against theft, vandalism, wilful damages, misdemeanours, and other illegal or undesirable activities. Sufficient deterrence shall be implemented to be in tandem with the progress of the Works.
- 1.9 The Contractor shall be aware that there may be other contractors employed or engage by the Authority to carry out works within the Site. Security measures shall cover these works carried out by other contractors, their site storage and facilities.
- 1.10 Security audit shall be carried at six (6) monthly intervals to detect lapses and other inadequacies of the Security Plan. Audit reports and propose corrective actions shall be submitted to the Engineer.
- 1.11 The Contractor shall improve his site security and or implement other measures required by the Engineer when he is of the opinion that the security measures are insufficient or where there are lapses in the security system.

2 HOARDINGS

- 2.1 The safety of vehicular movement onto and off Site shall be planned before the Site hoardings are erected to allow for features to be incorporated maximising public safety in connection with Site activities.
- 2.2 A 2.4 metre high durable metal perimeter hoarding shall be provided and maintained around the perimeter of the worksite and of all satellite locations to the acceptance of the Engineer. The hoarding shall be well designed and secured in place to prevent it being blown over by gusts of wind and shall be sufficiently robust to deter anyone from removing or displacing any panels. Regular maintenance on the hoarding shall be carried out.

- 2.3 At all work areas; suitable and effective gates shall be provided and shall be locked during non-working hours / days. Guard posts shall be constructed and guards shall be stationed at these posts. It shall be illuminated to enable the guards to carry out inspections at night. The guard shall inspect persons, vehicles, materials and other equipment entering and leaving site. Intercom or other communications shall be provided and maintained between the guard post and the security guard office.
- 2.4 Where it is not practicable to post security guards at gates to satellite locations as only infrequent access is required then these gates shall be kept securely padlocked and the key held by nominated supervisors. These nominated supervisors shall be held responsible for ensuring that the gates are locked after work has ceased there temporarily and the workers have left that location. These remote sites shall be secured and guard-patrolled during non-working hours / days at non fixed intervals.
- 2.5 At strategic locations along hoardings, entrances, guard posts and other facilities, spotlights shall be installed.
- 2.6 There shall be no unauthorised openings in the perimeter hoarding. All access and egress shall be via gates which are manned by 24-hour security guards - see Clause 2.7 below.
- 2.7 If for any reason the Contractor authorises any panels to be moved to create a temporary opening then a guard must be posted to restrict access to authorised personnel / construction equipment / plant / vehicles only. It shall permanently close immediately after works is completed.
- 2.8 Should there be any risk of materials, tools, waste material or similar escaping from any part of the Site either as projectiles or falling objects etc., then an effective extension for the Site hoarding shall be designed and erected to prevent this. Where a public footpath or pavement runs alongside the hoarding, overhead protection must be provided where Site activities pose a foreseeable risk of such occurrences.

3 PERSONNEL ACCESS

- 3.1 The Contractor shall be responsible for controlling worksite security to prevent unauthorised access, maintain public safety and minimise theft, vandalism, wilful damages, arson and other offences.
- 3.2 The Contractor shall ensure that no illegal workers or unauthorised persons are allowed on Site. The Contractor shall conduct both internal and external raids to weed out any illegal workers or unauthorised persons.

- 3.3 Security of the Site shall also be maintained to ensure that only those persons who have the skills and training to work safely on Site and who are wearing the appropriate Personal Protective Equipment (PPE) may be admitted.
- 3.4 At the main Site office, the Contractor shall set up a fully equipped security guard office at the entrance to the offices. The security guard office shall be at least 6m x 3m with direct view overlooking the entrance. A visitor book shall be maintained to record visitors entering/leaving the site or offices. Workers' security passes shall also be issued to all workers entering the Site. Visitor shall be issued with temporary passes. Ingress and egress of vehicles shall be logged.
- 3.5 A similar security pass system shall also be operated at the main entrance to all the sites. This shall preferably incorporate a turnstile / swipe card reader but any other equally effective means may be utilised with the prior acceptance of the Engineer.
- 3.6 Guard posts erected at the main entrances where access is to be controlled are to be staffed by trained employees of the Contractor or employees of a subcontract licence security agency. Sufficient guards shall be on duty at any one time to give effective 24-hour coverage. These trained guards shall wear uniform to enable easy identifications.
- 3.7 All guard posts shall be equipped with a telephone / radio communication system, a panic button and an audible alarm.
- 3.8 Two-way communication equipment shall be provided to the guards to maintain communication between guards at other security posts or on patrol and the security guard office. A general alarm system shall be installed for use in an emergency. The Engineer's site offices shall be installed with intruder alarms, and protection systems. The site offices surroundings shall be well lit.
- 3.9 The access control system shall cover all staff, direct employees of the Contractor, LTA project staff, interfacing contractors and service providers such as canteen workers, cleaning workers and similar as well as all subcontract staff / workers and those of sub-subcontractors etc. including operators of rental construction equipment / plant.
- 3.10 Each security pass shall bear the photograph of the holder and his NRIC No. / Passport No. and Work Pass / Employment Pass number as appropriate. It shall be issued after completion of site safety induction training via a central registry controlled by the Contractor. Temporary visitor passes may be issued for those personnel on authorised business, in which case their names must be recorded together with times of arrival and departure plus signature.

- 3.11 The Contractor shall issue first time security passes to the interfacing contractors. The cost of subsequent replacement of security passes will be borne by the interfacing contractors.
- 3.12 Persons not wearing the correct PPE shall not be allowed onto Site, unless they identify themselves as visiting the Site office only and the Contractor has provided a designated safe access route to and from the Site access control point for this purpose.
- 3.13 Control shall also be exercised over authorised workers entering and leaving the Site during non-working hours / days to prohibit any alcohol or illegal substances from being brought into the quarters which could foreseeable lead to fights or to other incidents. Periodic spot checks shall be carried out to deter theft, vandalism, damages or illegal activities.
- 3.14 An accurate headcount shall be kept of all persons entering the worksite so that they can all be accounted for in case of an emergency.

4 VEHICULAR ACCESS

- 4.1 Effective control shall be exercised over materials entering and leaving the Site, to check on the suitability / safety of construction equipment, Plant and materials delivered to Site and to prevent theft. For all materials including waste and salvaged materials, construction equipment and plants leaving the Site a proper record of authorisations given by the respective contractors issuing such removal chits shall be maintained.
- 4.2 Wherever practicable separate access and egress gates shall be provided. The control point for access should be located a short distance inside the main gate to permit a vehicle to pull off the road before halting to be checked.
- 4.3 A security post shall be provided at each vehicular access point, sited so that the checker has a clear view of incoming vehicle registration plates and any passengers in the cabin.
- 4.4 The Contractor shall provide the following at all designated site entrances and exits for vehicular access:-
- a) Illumination of at least 100lux;
 - b) Convex mirror (32 inch / 24 inch) at entrances / exit points adjoining roads;
 - c) Revolving light (complying with BS3143 Part 4 or an approved equivalent, e.g., Code of Practice for Traffic Control at work zone); and
 - d) Vehicle lay-by at all site entrances / exits point where possible.

- 4.5 Railings or similar should be erected inside the Site to prevent workers and others on Site from walking into the path of vehicles entering / leaving the Site.
- 4.6 To prevent all lifting machines and vehicles from infringing the height limit of 4.5m in public roads. The Contractor shall install effective and robust steel height barriers at all vehicular access. The steel height barrier shall be constructed with a height infringement gauge that limits the height of lifting machines and vehicles to less than 4.5m
- 4.7 Security drop-bars shall be maintained in the closed position at all vehicular entry and exit points to the Site and every vehicle shall be stopped outside the barrier. The barrier should only be raised after authority has been given to the driver of the vehicle to proceed. Hump shall also be constructed at exits.
- 4.8 The registration numbers of all vehicles entering and leaving the Site shall be recorded.
- 4.9 No goods shall be off-loaded at the Site entrance in a manner that creates a hazard to other vehicles entering / leaving the Site.
- 4.10 Vehicles waiting to get in to the Site should be directed to a designated holding area which minimises obstruction to other road users, and called forward by a flagman.
- 4.11 The main gates shall be closed and locked after construction work has ended for the day.
- 4.12 The main gates and control points are to be well lit during the hours of darkness.

5 SITE PATROLS

- 5.1 Security guards shall patrol the Site regularly during the night, non-working days and public holidays covering all locations within the Site perimeter to deter, detect and follow up any undesirable event such as theft, robbery, violence, damage to any property, trespass, etc. The areas to be covered shall include, but not be limited to Site offices, housing quarters, canteen area, materials stockyards and perimeter hoarding.
- 5.2 Clocking points shall be installed to record their presence. Guard patrols shall visit designated clocking points within the station and the perimeter of the station site at least four (4) times during the night and extra five (5) times during the day on non-working day. A register is to be kept to record the guards visits.

- 5.3 In addition to the above when the Works are near completion, guards shall patrol inside the station and clock at pre-determined clocking points at fixed intervals. Only one (1) or two (2) access points into the station shall be used and manned. All persons entering or leaving the station shall sign in or out and record their works or purpose. All materials and equipment (including those belonging to the interfacing contractors) brought into or out of the station shall be recorded. No materials or equipment shall be taken out of the station without authorisation.
- 5.4 All incidents shall be recorded and reported to the Engineer. In cases of emergency, the correct persons or appropriate emergency services shall be notified.

6 SECURITY GUARDS

- 6.1 Guards shall wear uniforms so that they can be readily identified. They shall be able bodied, adequately trained, approved by relevant authorities and shall have no criminal records. Guards on patrol shall work in pairs.
- 6.2 Personal Protection Equipment (PPE) shall be provided to the guards by the Contractor and they shall wear them when patrolling or visiting the sites. They shall also attend the safety induction course.
- 6.3 Guards shall be fully trained to handle various situations such as unauthorized entry into site, theft, vandalism, fire, accident, etc.
- 6.4 A full-time guard supervisor/superintendent shall be assigned to supervise and check on the guards. He shall be trained and well versed in security procedures, measures and system, including preparing monthly reports, incident reports, reviews and audits. He shall conduct security briefings, site security campaigns, provide information to workers on security and other preventive measures or deterrents.

CIVIL ENGINEERING / DEEP EXCAVATIONS**1 Excavations/Deep Excavations**

- 1.1 The Contractor shall appoint sufficient number of banksman to coordinate excavation activities at the pit and the haulage activities from the pit to the bank. The banksman shall be appointed in writing and should have attended signalman training course approved by MOM. The banksman shall be properly identified on site, stationed at-grade and have overall control of the excavation works.
- 1.2 For excavations exceeding four (4) metres in depth, the Contractor shall appoint at least one banksman within 30 metres length of excavation. If deemed necessary by the Engineer, the Contractor shall appoint additional banksman. For excavations exceeding 10 metres in depth, the Contractor shall appoint one (1) banksman for every long-arm or telescopic excavator at the bank.
- 1.3 Proper means of communication in the form of walkie-talkie sets should be established between the banksman and the excavator operators. No one shall be within any excavator's swing radius. In addition, all excavators shall be installed with rear view camera that enables the operator to have a clear view of the back of the machine.
- 1.4 Long arm excavators shall be provided with an extended reflective mirror in front of the operator's cabin to enhance operator's visibility and shall not operate without the presence of the banksman.
- 1.5 Excavators within the excavation pit shall have suitably reinforced cabin roofs capable of withstanding impact from falling objects from the top of the excavation and its movement coordinated by one of its operator, who shall be appointed as a leader by the Contractor.
- 1.6 The designated locations at walers and struts used by the instrumentation contractor for instrumentation reading and monitoring shall be provided with two (2) rows of horizontal rigid guardrails to prevent persons falling from height. Openings within struts are to be covered. The vertical distance between the two (2) rows of horizontal guardrail shall be not more than 600mm. Toe boards are to be provided accordingly.
- 1.7 An alternative source of power and emergency lighting system shall be provided to allow emergency securing operations and evacuation safely in the event of a primary power failure. An adequate number of lamps shall be located at key points underground.

2 Pipe Jacking

- 2.1 No person shall enter a pipe jack of less than 1,200mm in diameter.
- 2.2 All work within a pipe jack shall follow strictly the procedures for work within a confined space and a permit to enter procedure shall be followed.
- 2.3 All persons shall be out of the tunnel when jacking is taking place and shall not re-enter until the ram is no longer in motion.

3 Hand Driven Tunnels

- 3.1 Excavation by hand of a full tunnel face shall be from the top downwards, taking the face out in steps or benches and securing the top and face as soon as they are exposed. Wherever practicable, an open shield, extended in the crown with a hood, shall be used to provide initial support and protection unless otherwise acceptable to the Engineer. Faceboards held in place by hydraulic jacks may be necessary in soft ground conditions, if applicable.
- 3.2 Rings of segments shall be installed as close as practicable behind the working area in a pre-determined sequence by a mechanical erector, or by hand for smaller diameter drives, and the shield jacked forward off the completed segment lining.
- 3.3 Properly designed and installed working platforms shall be provided close to the face in tunnels over two (2) metres in diameter and work sequence controlled so that workers in the invert are exposed to the minimum of falls of soil or rock.
- 3.4 Hand mucking shall be employed at the face, with mechanical means for muck removal following close behind, where the diameter of the drive permits.

4 Emergency Plan

- 4.1 The Contractor shall identify all possible emergency situations specific to the contract and submit an emergency plan to the Engineer for approval.
- 4.2 The plan shall address the emergencies specifically for the various locations within the contract in terms of assembly areas, emergency equipment, access / egress, and etc. Review levels (alert levels and work suspension levels) from instrumentation monitoring works shall form part of the emergency evacuation criteria.
- 4.3 The Contractor shall work with the Singapore Civil Defence Force (SCDF) to develop the emergency plan. The plan shall be communicated to all the personnel within the Site.

4.4 The Contractor shall, once every six (6) months, organise tabletop emergency exercises based on likely site scenarios in which the key site personnel work through their emergency response roles. SCDF shall be included in the emergency drills. LTA's CSEP Division shall be invited to this exercise as an observer.

4.5 The Contractor shall conduct in-house emergency exercises and drills on a quarterly basis and conduct joint emergency exercises and drills with the SCDF at least twice (2) per year.

5 Escape Staircase and Walkways

5.1 The Contractor shall provide at least two (2) staircases as a minimum. The staircases shall be positioned in such a manner to facilitate the evacuation of all personnel within 10 minutes from the excavation area.

5.2 The emergency escape staircases shall comply with Clause 31.3 (Emergency Preparedness) of Appendix A. The use of similar staircases to the drawing attached in this annex or otherwise shall be approved by the Engineer.

5.3 At least two (2) sets of emergency alarm shall be provided from independent power source, such that the second emergency alarm can be activated upon the first alarm failure.

5.4 The Contractor shall provide proper walkways along struts and walers for access and egress. Walkways shall also be provided on planned emergency escape routes.

5.5 The Contractor shall ensure that all staircases have anti-slip strips / paint to prevent slip and fall. Weekly inspections to be carried out to check and replace all worn out anti-slip strips / paint and damaged steps. Daily housekeeping to keep the staircases clean and free from oil, grease, dirt or mud.

5.6 The Contractor shall educate the workforce on the use of 3-point contact when using staircases.

6 Man cage for Emergency Rescue

6.1 The Contractor shall provide at least one (1) man cage at each excavation area for emergency rescue operation. The man cage(s) shall be located at a place accessible or available within five (5) minutes from any accident location within the excavation area.

7 Instrumentation and Monitoring Meetings

- 7.1 The Contractor's WSH Officers shall attend all site monitoring meetings to be updated with the instrumentation readings of the Works so that he can advise the Contractor on the appropriate actions to be taken.

8 Radio Frequency Identification (RFID) Tracking System

- 8.1 The Contractor shall implement a RFID based personnel tracking system for all deep excavation works, underground stations and tunnels on site. The system shall track the movement of workers going in and coming out of these areas.
- 8.2 The system shall not require the deliberate action of the worker in order that his presence and movement be sensed, such as close proximity sensing using Ultra High Frequency (UHF) RFID technology, swiping of magnetic strip ID cards. The system shall allow bi-directional tracking at each access point and location tracking with one or more access points to a location. This shall include the tracking of the worker's last known location to facilitate emergency rescue works.
- 8.3 The system shall also provide instant information update and allow users to view the information using standard web browser: real-time count of workers in one or more locations, trace entry and exit timings of workers at access points, duration of stay at each locations for each period for individual workers, the total time that is spent by workers of each trade, additional information such as personnel name, ID, location and entry time stamp.

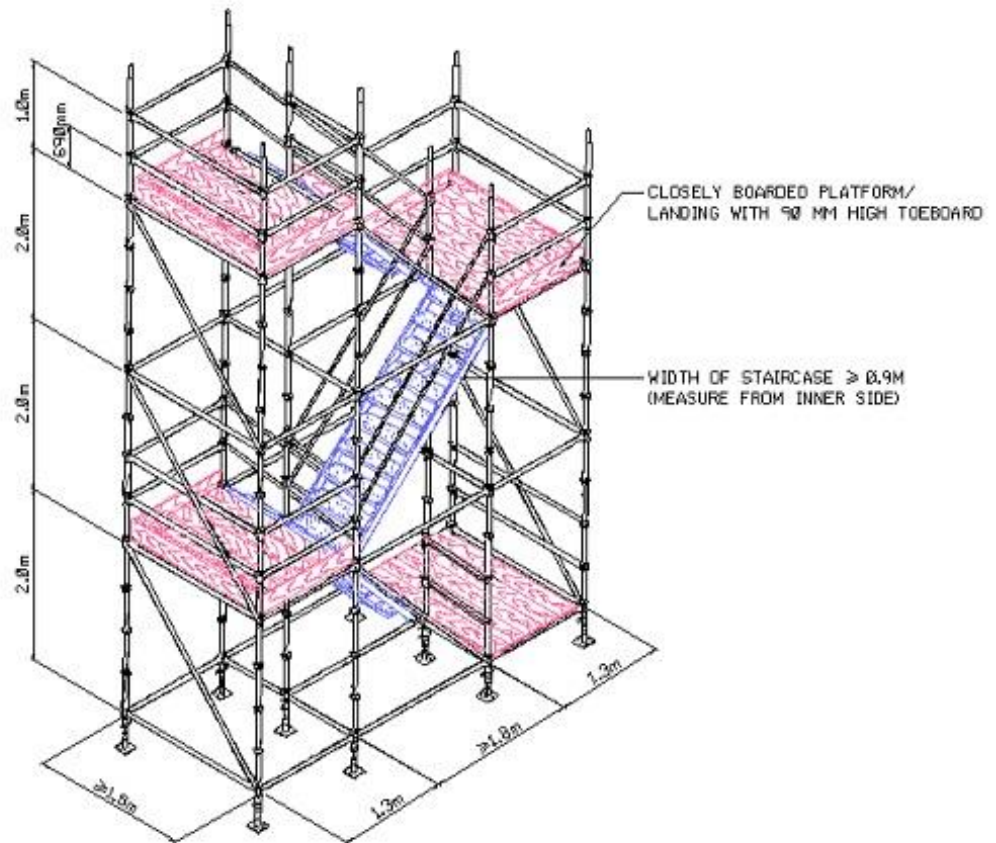

KEY DIMENSIONS OF MODULAR STRUCTURAL STAIRCASE FOR DEEP EXCAVATION

NOT TO SCALE

TEMPORARY HOUSING QUARTERS

- 1.1 The Contractor shall obtain the Engineer's approval before planning to house workers within the boundary of the construction site.
- 1.2 The Contractor's housing quarters shall comply with SS547: 2009, Code of Practice for Temporary Housing Quarters on Construction Sites.
- 1.3 The Contractor shall provide a separate canteen and provide meals for all his workers on site and ensure that workers do not cook within the housing quarters.
- 1.4 The Contractor shall appoint a quarter supervisor and a team of housekeeping workers to maintain discipline, quarter rules and control of illegal workers and housekeeping of all facilities including the washing areas, toilets, bathing facilities etc.

APPROVAL PROCEDURE FOR USAGE OF NEW HEAVY EQUIPMENT IN LTA WORKSITES

Introduction

1 All **New Heavy Equipment** entering LTA worksites shall require approval by the LTA Project Director (PD) before it is mobilized to the Contractor's worksite. The definitions for **New** and **Heavy Equipment** are given below:

1.1 **New** refers to:

- i. New machine (not used before in LTA worksites); or
- ii. New model (of an existing brand of machine in LTA worksites); or
- iii. New operator (of an existing model of machine in LTA worksites or change in operator of an existing model of machine in LTA worksites); or
- iv. New modifications (made to an existing model of machine in LTA worksites)

1.2 **Heavy Equipment** refers to:

- i. Any equipment with a high Centre of Gravity (CG), including all Lifting Machineries (LM) such as Boring Rigs, Trench Cutters and Grouting Machines (e.g. Deep Soil Mixing Machines, Wet Soil Mixing Machines) etc; or
- ii. Any type of heavy equipment not commonly used in LTA worksites.

Procedure (See also Flow Chart – Annex A-f1)

2 If the Contractor intends to use a **New Heavy Equipment**, he will first notify LTA Project Team (PT) of his intention and submit Method Statements pertaining to the **New Heavy Equipment** and type of work involved **at least three (3) months** before work starts. The submissions should include (but not be limited to) the following:

2.1 Equipment Details:

- a) Technical specification and operator's manual
- b) Catalogue
- c) Safe Work Procedures¹
- d) Risk Assessment¹
- e) Certification of Equipment by Authorized Examiner (*if any*)
- f) Maintenance Records (*if any*)

- 2.2 Operator and Mechanic Details:
- a) Training materials
 - b) Training frequency and duration
 - c) Assessment and certification procedures
 - d) Names and certification records

The Contractor should also provide any other materials or information which he opines will further support his application.

- 3 The Methods Statements will be reviewed by LTA PT and CSEP Division. The Contractor shall also be able to furnish, from time to time, any other materials or information which the PT or SD requires.
- 4 Once the submission is in order, the LTA PT shall notify the Contractor to arrange for a presentation by the **New Heavy Equipment** Manufacturer or Principal Agent on the suitability and safety of the proposed Equipment. The LTA PT, PD, SD, Main Contractor and the approving Authorized Examiner (AE) shall be present during the presentation. The manufacturer or principal agent shall cover (but not be limited to) the following topics in his presentation agenda:
 - a) Safety Features of the Equipment
 - b) Location of Centre of Gravity (CG) (*for Lifting Machineries*)
 - c) Operating radius and limitations
 - d) Previous incidents or accidents involving the Equipment (*if any*)
 - e) Permitted modifications to the Equipment
 - f) Recommended maintenance regime

The manufacturer or principle agent should also include, in his presentation, any other details which he opines will be useful. The manufacturer or principle agent, and the Main Contractor shall be prepared to answer any queries and clarifications posed by LTA PT, PD, SD and / or AE.

- 5 Following the presentation, the Contractor shall arrange for an interview with the proposed operator and mechanic to assess their competency in operating and maintaining the **New Heavy Equipment**. The interview shall be conducted by LTA PT and SD and any other personnel deemed suitable by the interviewers. The operator and mechanic shall be assessed based on the following:
 - a) Competency in operating / maintaining the proposed equipment
 - b) Relevant experience in operating / maintaining the proposed equipment
 - c) Relevant and appropriate training by manufacturer or principle agent
 - d) Any debarment records
 - e) Records of certification for specific model by manufacturer or principal agent

- 6 Once the above processes have been completed, LTA PT will proceed with the submission for approval. If LTA PM / SPM / PRPM is not satisfied with the Contractor's proposal, he shall reject the application and state the reasons for his rejection. The Contractor shall then either propose an alternative operator or equipment for use, depending on the reasons for rejection.
- 7 If LTA PM / SPM / PRPM is satisfied with the Contractor's application, he shall proceed to complete Part 1 of the **New Heavy Equipment** Application Form (Annex A-f2) and circulate it to SD for review and to fill up Part 2.
- 8 Upon PD's approval in Part 3 of the Form, the LTA PT will then notify the Contractor to mobilise the **New Heavy Equipment** into his worksite. Should there be any discrepancy between SD and PD's decision, the decision of the PD is final.

FLOW CHART FOR USE OF NEW HEAVY EQUIPMENT IN LTA WORKSITES

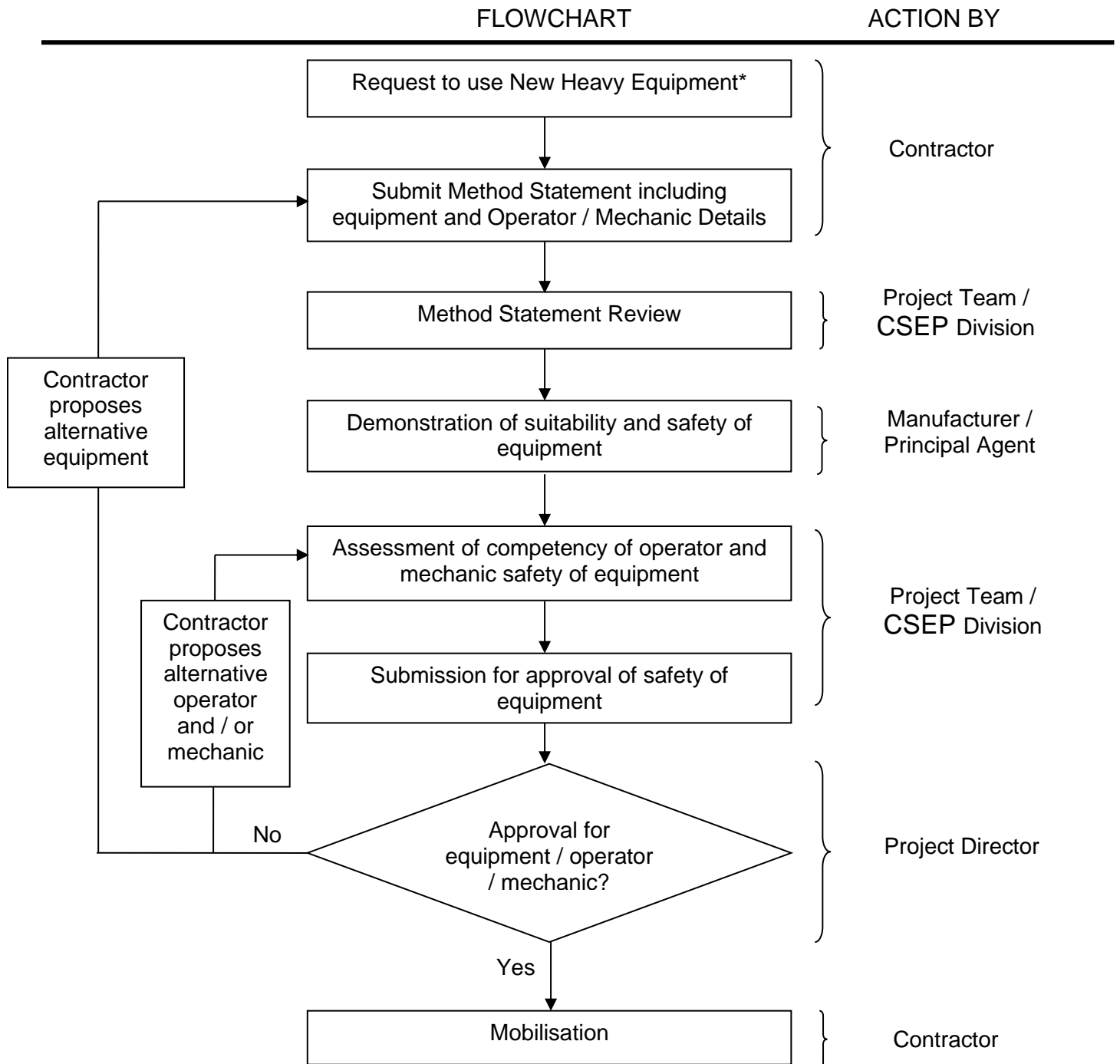

*Heavy Equipment includes Lifting Machineries (LM) such as Boring Rigs, Trench Cutters and Grouting Machines (e.g. Deep Soil Mixing Machines, Wet Soil Mixing Machines).

APPLICATION FOR USE OF NEW HEAVY EQUIPMENT	
Part 1 (To be completed by LTA PM / SPM / PRPM)	
Contract No. / Contractor	
The Contractor has effectively demonstrated the suitability and safety of his New Heavy Equipment and the competency of his proposed Operator and Mechanic, and submitted the following documents:-	
<input type="checkbox"/> Justification on the required model of Heavy Equipment; <input type="checkbox"/> RA, SWP, Technical Specifications and Operator's Manual of Heavy Equipment; <input type="checkbox"/> Competency and training certificates of Operator / Mechanic for the Heavy Equipment; <input type="checkbox"/> Training materials for Operator training; and <input type="checkbox"/> Records of past maintenance carried out for the Heavy Equipment <i>(if any)</i> ; Submission is endorsed / not endorsed* (state reasons):	
PM / SPM / PRPM's Name:	Signature:
Contact No:	Date:
Part 2 (To be completed by LTA CSEP Division)	
Submission is supported / not supported * (state reasons):	
Reviewed by Name / Signature:	Date:
Verified by DDCSEP / Signature:	Date:
Part 3 (To be completed by the LTA PD#)	
Submission is approved / not approved* (state reasons):	
PD's Name:	Signature:
Contact No:	Date:

*Delete whichever not applicable

#The Deputy Director may approve on behalf of the PD if there are valid reasons for doing so.

ENVIRONMENTAL CONSIDERATIONS

1. GENERAL

- 1.1 The Contractor shall be responsible to identify, manage and mitigate all environmental impacts which result from his construction activities. Such impacts include any form of pollution and excessive noise affecting those outside the site boundary.
- 1.2 The Contractor shall comply with all relevant Acts, Regulations and Codes of Practice of Singapore including any amendments or re-enactment thereto including but not limited to:-
- Code of Practice on Environmental Control Officer (ECO);
 - Code of Practice on Environmental Health;
 - Code of Practice for Noise Control on Construction and Demolition Sites
 - Code of Practice on Pollution Control;
 - Code of Practice on Surface Water Drainage;
 - PUB's Guidebook on Erosion & Sediment Control at Construction Sites; and
 - NEA's Handbook of Scope of Works for Mosquito Control.
- 1.3 The Contractor shall adopt the best environmental practices highlighted in the following:-
- Guidebook for Best Environmental Practices: Construction Waste Management at LTA Sites;
 - Guidebook for Best Environment Practices: Noise Control at LTA Sites;
 - Guidebook for Best Environmental Practices: Vector Control at LTA Sites;
 - Guidebook for Best Environmental Practices: Water Resource Management at LTA Sites; and
 - All other LTA environmental guidebooks and guidance (e.g. (i) Noise Guidance: Developing a Noise Management Plan in LTA Projects and (ii) Workplace Safety, Health and Environmental Good Practices Handbook)
- The LTA guidebooks and guidance are available for viewing during the Tender Stage. A copy of the guidebooks will be issued to the Contractor upon award of the Contract.
- 1.4 If a Project Environmental Study (PES) was conducted for the project, the Contractor shall:
- a) Comply with the recommendations in the PES Report. In the event of differences between the PES Report and other relevant authorities' requirements, the Contractor shall adopt the more stringent requirements;

- b) Conduct an Environmental Impact Workshop within the first two (2) months upon the signing of Contract or as subjected to the Engineer's approval to establish site specific environmental management. The Contractor's Project Manager shall organise and lead the Environmental Impact Workshop to update and discuss with the Engineer on what has/will be implemented in response to the impacts and mitigation measures identified in the PES Report;
- c) Provide justifications and alternative solutions to reduce the impacts to as low as reasonably practical, subjected to approval by the Engineer in the event that the requirements of the PES Report cannot be implemented;
- d) Submit site-specific Environmental Impact Register in the format stated in Attachment A-6, according to the phases of construction. The Contractor shall document the mitigation measures that will/have been implemented to address the environmental impacts identified in the PES Report; and
- e) Manage and implement the Environmental Impact Register on a regular basis, or when necessary.

1.5 The Contractor shall submit site-specific environmental management plans which takes into consideration the relevant Regulations, Codes of Practice, LTA environmental guidebooks, guidances, and recommendations stated in the PES Report (if a PES had been conducted). These management plans shall be submitted to the Engineer for approval within three (3) months of contract award or as subjected to the Engineer's approval:

- a) Air Pollution Control Plan (shall include at minimum, requirements of air pollution control stipulated in Clause 5 of (y) summary of noise);
- b) Vector Control Plan (shall include at minimum, requirements of rodent control and mosquito control stipulated in Clause 7 of Annex A-g);
- c) Waste Management Plan (shall include at minimum, requirements of solid waste management stipulated in Clause 8 of Annex A-g);
- d) Noise Management Plan (shall include at minimum, requirements of noise control stipulated in Clause 9 of Annex A-g);
- e) Earth Control Measures Plan (shall include at minimum, requirements of ECM stipulated in Clause 10 of Annex A-g); and
- f) Environmental Impact Register (if applicable)

1.6 The details and comprehensiveness of the plans shall be relevant to the complexity and scope of Works.

- 1.7 The Contractor shall continuously review and revise these management plans and they shall be submitted at least six (6) weeks prior to commencement of work due to:
- Change in site location,
 - Change in construction phase,
 - Change in construction activities, or
 - As and when necessary.
- 1.8 The Contractor's environmental team shall comprise sufficient workers (i.e. at least 2) solely for the upkeep of environmental control and maintenance. These environmental workers shall be easily identifiable by attire, e.g. a different safety vest or helmet. In the event that environmental non-compliance is found or the site condition does not meet the required performance standards as deemed by the Engineer, the Contractor shall deploy additional workers to support the environmental team. These additional workers have to be trained in environmental control and maintenance, and shall be pre-identified by the contractors, and they can be employed to work as part of the construction.
- 1.9 The ECO shall attend professional courses, trainings, workshops or seminars recommended by the Engineer or published by NEA, PUB, Institute of Engineers, Singapore (IES), other relevant authorities or professional bodies. The ECO must ensure that the team of environmental workers have adequate training and knowledge of their job scope, and training records of these personnel are to be kept.
- 1.10 The ECO shall be registered with the National Environment Agency (NEA) and have at least three (3) years of post-registration and practical experience relevant to the scope of Works of the Contract. If this requirement is not met, the Engineer may require that the proposed ECO to be employed on a six (6) month probation basis. Commencement of permanent employment is dependent on the performance of the ECO during the period of probation.
- 1.11 The Contractor shall put in place additional measures and resources as required by the Engineer if current measures/ resources are deemed insufficient. The Contractor shall deem to have considered means and included all costs to ensure that their operations are conducted in compliance to local environmental regulations and in an environmentally responsible manner. Any variation claims or claims for extension of time will not be permitted.

2. RESOURCE CONSERVATION AND MANAGEMENT

- 2.1 The Contractor shall reduce energy and water consumption of the attached site offices by using energy-saving and water conservation appliances, adopting conservational practices and monitoring consumptions through smart meters.
- 2.2 For contracts above \$20 million, the Contractor shall appoint a Water Controller as per PUB's requirements on site. The Water Controller should at least be of an Engineer level and shall monitor water consumption on site and submit a Water Efficiency Management Plan yearly. The Contractor shall document and maintain all appliances and conservation practices.

Electrical Appliances

- 2.3 Electrical appliances such as refrigerators and air conditioners shall be procured from registered suppliers supplying registrable goods affixed with the Energy Label where the Energy Label shall be affixed only after the NEA has issued the Certificate of Registration (COR) for the model purchased.

Note: Registrable goods refer to goods listed under the Energy Labelling Scheme as specified by NEA.

- 2.4 The appliance shall have its energy efficient rating rated "Excellent". Air conditioners at site offices are required to have a Global Warming Potential (GWP) of ≤ 750 .
- 2.5 The Contractor shall ensure that air conditioners are serviced regularly at a frequency of at least once a year to ensure the efficient running of the air conditioner. Air conditioners temperature is to be maintained at ≥ 25 degree Celsius.
- 2.6 Energy efficient lightings shall be used. Lights in the toilets are to have motion sensor feature.

Water Efficient Products

- 2.7 The Contractor is required to install water efficient products based on the Mandatory Water Efficiency Labelling Scheme (Mandatory WELS) as well as from the Voluntary Water Efficiency Labelling Scheme (Voluntary WELS) implemented by PUB.
- 2.8 Water efficient products used in site office such as basin taps and mixers, low-capacity flushing cisterns, urinal flush valves and shower heads shall be rated with three ticks.

- 2.9 For contracts above S\$20million, the Contractor shall install private water meters at various water usage areas to track and monitor water consumption on site and workers' dormitory (if any) in accordance with Public Utilities (Water Supply) Regulations.
- 2.10 The Contractor is to use recycled water obtained through ECM treatment plants for non-potable water usage, where possible.

Paper Saving

- 2.11 The Contractor shall as far as possible, where printing is necessary, print on both sides of the paper.
- 2.12 The Contractor shall procure site office items accredited with green label (e.g., SGLS+ for printing paper).

3. SUBMISSION OF ENVIRONMENTAL INFORMATION

- 3.1 The Contractor shall submit operating and pollution data for his proposed plant and equipment when required by the Engineer.
- 3.2 The Contractor shall also maintain and make available resource usage data of the project. The data shall be in accordance with the scope of assessment defined in Attachment A-7 or as specified by the Engineer.
- 3.3 The Contractor shall be responsible for the accuracy of the data and auditable records shall be kept for verification or as requested by the Engineer.

4. CLIMATIC AND TIDAL CONDITIONS

- 4.1 In planning the control measures necessary to minimize environmental pollution, the Contractor shall take into account the climatic conditions in Singapore. Detailed statistics can be obtained from NEA's Meteorological Service Division.
- 4.2 Where the state of the tide would affect the control measures being implemented to minimize environmental pollution, the Contractor shall make reference to the tidal information available from the Maritime and Port Authority (MPA) of Singapore.

5. AIR POLLUTION CONTROL

- 5.1 The Contractor is required to implement all necessary measures to prevent and control any atmospheric pollution (in the form of smoke, fumes, vapours, dust and other pollutants) on site. Accordingly, the Contractor shall undertake the following but not limited to:
- a) Submit a detailed air pollution control plan with the reporting format as specified in Attachment A-8 within three (3) months of Contract Award or as subjected to the Engineer's approval;
 - b) Ensure all air pollution control requirements such as the concentration and rates of emission of air pollutants are within legal limits;
 - c) Shield and / or arrest air pollutants with appropriate means, e.g. use of mechanical means, at source;
 - d) Pave all vehicular access with suitable materials such as concrete, mill waste or hardcore; and
 - e) Cover all temporary stockpiles with canvas sheets or erosion control blankets.
- 5.2 The Authority reserves the right to request for a newer machine or an emission control device to be installed if any machine or plant is deemed to be producing excessive smoke.

6. WATER AND LAND POLLUTION CONTROL

- 6.1 No trade effluent other than that of a nature or type approved by NEA Director-General shall be discharged into any watercourse or land.
- 6.2 All activities involving repair, servicing, engine overhaul works etc. shall be carried out on an area which is appropriately contained (e.g. concreted area and with steel plates) and all wastes shall be channelled for appropriate treatment or disposal to meet the regulations. Oil removers/interceptors shall be provided to treat oil waste from workshop areas.
- 6.3 Diesel drums and chemicals shall be stored under shelter within concrete bund walls or in storage containers with good ventilation. Spill trays shall be provided for all drums, plants and machineries and potentially pollutive substances used on site. Spill trays shall be regularly maintained to prevent rain from washing out the pollutive substances.
- 6.4 The Contractor shall put in place a response plan to cater for accidental spillages into any watercourse. This plan shall be communicated to all project personnel.
- 6.5 The Contractor shall conduct an emergency spillage exercise at least once per year.
- 6.6 Emergency spill kits shall be provided on site in the event of any chemical spillages. Emergency response teams shall also be competent in the use of these spill kits.
- 6.7 All accidental spillages and trade effluent discharges shall be investigated and reported to the Authority.
- 6.8 Use of diesel on site shall also follow Clause 29.5 to 29.8 of Appendix A.

7. VECTOR CONTROL

- 7.1 The Contractor is required to implement comprehensive vector surveillance and control on site, including all necessary measures to prevent the site from becoming favourable to the breeding and harbouring of vectors.
- 7.2 The Contractor shall submit a Vector Control Plan with the reporting format as specified in Attachment A-9 within three (3) months of Contract Award or as subjected to the Engineer's approval. Chemicals to be used for application are subject to the Engineer's approval.
- 7.3 The Contractor shall form an in-house pest control team to carry out vector surveillance and control work. Personnel involved in vector surveillance and control shall undergo relevant trainings which include but not limited to:

- Joint ITE-NEA Certificate in Pest Management for ECO or in-house pest control team supervisor;
- Joint ITE-NEA Certificate in Pest Control for in-house pest control team; and
- Trainings on understanding vector-borne diseases, identifying potential vector breeding grounds and measures to prevent the propagation of vectors for general workers.

7.4 The Contractor shall engage an external NEA-licensed Vector Control Operator (VCO) to supplement the in-house vector surveillance and control. The VCO shall carry out vector control and surveillance at least once a week. Additional VCO services will be required during epidemic periods and incremental costs to provide for additional VCO services are deemed to have been included.

7.5 During the construction period, the Contractor or his hired VCO must maintain a site register which gives an up to date account of surveillance and control work that has been carried out. This register must be made readily available upon request.

7.6 Any person found on site to be a carrier of or contracted with the dengue/dengue haemorrhagic fever, zika, malaria, Chikungunya or any other vector-borne disease shall be removed from site to prevent transmission of the disease. The Contractor shall develop a response plan specifying the measures to be taken in the event that any person found on site is discovered to be a carrier of or contracted with any vector-borne disease.

Mosquito Control

- 7.7 Source reduction shall be the main form of mosquito control on site, which includes but not limited to the following control measures:
- Keep good housekeeping;
 - Construct and maintain a proper drainage system;
 - Dispose unwanted receptacles;
 - Remove stagnant water from canvas sheet, water tanks and containers;
 - Trim excessive vegetation; and
 - Check for defects of potential breeding grounds and rectify (e.g. fill up ground depression).
- 7.8 In the event stagnant water cannot be thoroughly removed, larvae and pupae control shall be carried out to eliminate or prevent mosquito from breeding, through the application of anti-mosquito oil, non-restricted larvicide, and *Bacillus thuringiensis israelensis* (Bti) or equivalent. The Contractor shall ensure control measures are administrated to all potential areas of breeding. Pesticides classified under “Restricted Use” shall only be handled by licensed VCO, and the Contractor’s in-house pest control team shall not be involved in the use of such restricted items.
- 7.9 Prior to the commencement of site clearance, the Contractor shall identify any irregularities within the site for potential pre-existing vector conditions. VCO shall be engaged to review, propose and carry out intervention/supplementary measures for the control of mosquito breeding and rodent infestation. In the event of pre-existing vector conditions, the Contractor shall provide supporting documents and consult NEA for control measures.
- 7.10 The in-house pest control team shall carry out search and destroy activities of any potential breeding grounds, especially after every rainfall, using the “zoning method”. The team shall:-
- a) Divide the construction site into a maximum of three (3) zones for vector control particularly for mosquito control;
 - b) Carry out vector surveillance and control activities in at least one (1) zone per day; and

- c) Ensure that sub-contractors are carrying out proper housekeeping at their individual work zones to complement the in-house pest control team's effort.

- 7.11 The Contractor shall regularly monitor the adult mosquito population using well-maintained gravitraps. Gravitrap shall be placed in an area with good housekeeping, under shade and on a levelled ground for it to be effective. The records shall be documented and submitted to the relevant agency when requested.
- 7.12 Thermal fogging shall only be carried out when there is high population of adult mosquitoes and / or when the sites are located in dengue / zika clusters. The Contractor shall ensure that the VCO has obtained approval from NEA before fogging is carried out on site.
- 7.13 All site offices / containers must have a sloping / pitched roof installed with the sides adequately shielded from rain. Containers for office or storage purposes on site shall be sited on concrete paved ground with perimeter drains for effective surface water drainage.
- 7.14 The Contractor shall ensure that no puddles of water are formed on the ground by using appropriate cover such as concrete paved, milled waste or steel plates.
- 7.15 The Contractor shall adopt the LTA Dengue Contingency Plan (specified in Section 6 of Attachment A-9) and shall report all suspected dengue / zika cases to the Authority based on the response plan.
- 7.16 In the event where mosquito breeding is discovered on site by NEA, the Contractor is to carry out a Vector Control Time-out. The Time-out shall involve thorough search and destroy effort to eliminate any potential breeding grounds.
- 7.17 The Contractor shall implement a system of tracking and maintain an updated list of all personnel entering the site. The information shall include at a minimum the personnel's nationality and residential address.
- 7.18 The Contractor shall have isolation procedures and a room on site to isolate worker(s) suspected to have contracted dengue / zika. This room shall be designed to prevent mosquitoes from entering and shall also be well-ventilated.

Rodent and Fly Control

- 7.19 Source reduction shall be the main form of rodent and fly control. Food shall be properly stored in rodent-proof container with close-fitting lids in designated food storage area, and consumption must be strictly restricted to designated canteen or worker rest areas where lidded rubbish bins are available.
- 7.20 Food waste shall be contained in plastic bags before disposal into bins. Food waste shall be removed daily and the bins shall be cleaned regularly to prevent fly and rodent infestation.
- 7.21 In-house pest control team and NEA-licensed VCO shall also look out for evidences of rodents and their burrows during their rounds. Also, the in-house pest control team shall seal up cracks and holes on site to deter rodents' ingress.

8. WASTE MANAGEMENT

- 8.1 The Contractor is required to identify all types of waste (e.g. tunnelling waste, chemical waste, wood waste, metal waste etc.) and implement a comprehensive waste management system at the site in order to minimise wastage, ensure proper disposal and prevent pollution to the environment.
- 8.2 The Contractor shall submit the waste management plan to the Engineer for comments within three (3) months of Contract Award or as subjected to the Engineer's approval. The waste control plan shall be in line with reporting format in Attachment A-10.

Solid Waste Management

- 8.3 The Contractor shall carry out effective on-site sorting of construction and demolition waste, for example, separate skip bins for construction waste; wood waste; metal waste, etc. (to recover inert, reusable and / or recycle-able portion shall be provided). These skip bins shall be properly labelled.
- 8.4 The system of on-site sorting and temporary storage of construction and demolition waste shall include but not limited to the following:
- a) Metals shall be recovered for collection by recycling contractors;
 - b) Cardboards and paper packaging shall be recovered, properly stockpiled in dry and covered conditions to avoid cross contamination by other construction and demolition materials; and
 - c) Excavated materials shall be sorted to recover inert portions (e.g. soil and crushed rocks) for re-use on site or disposal to designated filling areas.
- 8.5 An adequate number of bins of capacity not less than one (1) cubic metre shall be provided on site for the storage of all inorganic waste such as building debris, scrap metal, dust, dirt and litter.
- 8.6 An adequate number of bins with air-tight covers of not less than 85 litres shall also be provided for the storage of organic waste on site, especially at canteens and rest areas.
- 8.7 All bins containing the site waste shall be cleared regularly to prevent build-up in these bins. They shall be removed from site and replaced / emptied once they have been filled.

- 8.8 All construction debris (under category C&D) shall be disposed of at the gazetted Government dumping grounds or at such other sites or locations as directed by NEA. Disposal of domestic refuse may be arranged with the Environmental Public Health Division (EHD). The Contractor shall pay all tipping fees at the gazetted dumping grounds.
- 8.9 The Contractor shall conduct housekeeping at least once a day to ensure that all litter is cleared from site.
- 8.10 All waste listed in the Environmental Public Health Regulations (i.e. General Waste and Toxic Waste) shall be disposed in accordance to the regulations and by NEA licensed waste operator/collector. Records of the disposal of these wastes shall be kept for audit purposes.
- 8.11 The Contractor shall not allow animals e.g. dogs to be present on site. All food waste shall also be protected from animals scavenging for food.

Wastewater Management

- 8.12 The Contractor shall ensure that discharge of wastewater complies with all applicable statutory regulations, including the Sewerage and Drainage Regulations and Environmental Protection and Management Regulations.
- 8.13 The Contractor shall submit the process for wastewater management as part of the Waste Management Plan as specified in Attachment A-10.
- 8.14 For wastewater (such as wastewater laden with chemicals from boring, diaphragm wall construction, EPB / slurry tunnelling, washing activities, etc.) generated due to the Contractor's work, the Contractor shall provide adequate separate containment, apart from surface runoff, and either treat in-situ to allowable discharge limits before discharging or dispose via licensed waste collector. The Contractor shall note that Earth Control Measures (ECM) are meant for the containment and treatment of silty rainwater runoff only, and not meant for the treatment of process water, such as oil, grease, cement and bentonite from tunnelling activities.
- 8.15 The Contractor shall minimise the volume of wastewater generated at source. Methods shall include reducing groundwater ingress into work areas, such as station, tunnel and shaft; reducing water usage for washing of tunnel and opting for manual scooping of spilled muck; minimising mixing of rainwater with wastewater; providing secondary containment for chemical drums inside TBM, etc.

- 8.16 For wastewater that is treated in situ on site, the Contractor shall seek the approval of the relevant authorities, including PUB and NEA, prior to discharging the treated wastewater into the sewer, watercourse or controlled watercourse. The Contractor shall engage a wastewater solution provider to design, install and maintain adequate treatment system to treat the wastewater to meet the respective allowable limits for the relevant parameters, such as pH, total suspended solid, total dissolved solid and chloride, before discharging the wastewater.
- 8.17 The Contractor shall also send samples of the treated wastewater at the final discharge point to an accredited laboratory for analysis to determine compliance with the applicable Environmental Protection and Management (Trade Effluent) Regulations or Sewerage and Drainage (Trade Effluent) Regulations, depending on the location of the discharge point, on a quarterly basis, or as and when requested by the Engineer. The Contractor shall maintain a proper record of all the sampling reports.

9. NOISE MANAGEMENT

- 9.1 A Noise Management Plan (NMP) relevant to the scope and complexity of the project shall be developed and submitted to the Engineer within three (3) months of contract award or as subjected to the Engineer's approval.
- 9.2 For contracts above S\$20 million, the Contractor shall appoint an acoustic consultant with at least three (3) years of relevant experience, subject to the Engineer's approval, to prepare the NMP on behalf of the contractor and shall adopt the reporting format as specified in Attachment A-11a. For contracts below S\$20 million or subjected to Engineer's approval, the NMP may be prepared by the Contractor as specified in Attachment A-11b.
- 9.3 This NMP shall be developed, where applicable, from making reference to the PES, where impacts and recommendations are described in the Noise Impact Assessment, as mentioned in clause 1.4. The NMP shall be site-specific and in accordance to the respective construction phases of work. It shall be implemented once approved. The proposed NMP shall include but not limited to the following requirements:
- a) A baseline survey of noise levels conducted on a continuous basis for a period of one week (refer to clauses 9.43 - 9.47). The survey period shall include at least a weekday and a weekend.
 - b) Site-specific mitigation measures (refer to clauses 9.16 - 9.42) including but not limited to acoustic enclosure(s) in accordance with the respective construction phases.
 - c) Noise simulation (for contract sum S\$10 million and above, and of structural and building work scope) by first taking into account the baseline survey of noise levels and Noise Sensitive Receivers (NSRs). Subsequently simulation shall be conducted using sound modelling software such as CadnaA, SoundPlan or equivalent, to determine the predicted noise levels during each construction phase (including major traffic diversion). Finally, simulation shall be conducted to determine the noise levels after the installation of proposed mitigation measures, which shall meet the allowable noise limits for all NSRs.
 - d) A public relations and feedback management plan shall be established.

- 9.4 The Noise Management Plan shall be submitted and presented to the Engineer for approval prior to the implementation of mitigation measures. If noise levels recorded are found to breach the permissible limits set out by the relevant authority, the mitigation measures shall be reviewed and the Noise Management Plan shall be re-submitted to the Engineer for approval.
- 9.5 The Acoustic Consultant (where applicable) shall propose and conduct regular site inspections on the implementation of the noise mitigation measures. During the inspections, noise monitoring shall be conducted to test the effectiveness of the mitigation measures. A report shall be submitted at the end of every inspection and review of measures shall be done when the measures are deemed inadequate by Consultant.
- 9.6 The Contractor shall monitor and measure the effectiveness of the mitigation measures throughout the construction phase of the project.
- 9.7 The Contractor shall notify the Engineer immediately and keep a copy of all fines/complaints/ stop work orders received.

Consideration for School Examination Periods and Public Feedback

- 9.8 The Contractor shall note that all construction works, which generate substantial noise, shall not be carried out during the school examination periods.
- 9.9 The Contractor shall obtain an official confirmation of the examination schedules from the School Administrator including revision of schedules.
- 9.10 The Contractor shall note that the Engineer has the right to give instructions to stop construction work activities temporarily during school examination periods, near to any educational institutes or schools.
- 9.11 The Contractor shall deem to have scheduled his work programme accordingly so as to avoid delay. Any claim for extension of time will not be permitted.
- 9.12 The Contractor shall commit sufficient resources into public relations work to establish good rapport with the community. The Contractor shall engage stakeholders and the community before commencement of Works and regularly throughout the work duration. Such activities shall be subject to the Engineer's approval.

- 9.13 The Contractor may be directed by the Engineer to suspend works immediately due to public feedback of noisy activities arising from the Works. The Contractor shall take adequate measures to protect all uncompleted works. Where the relevant works are temporary suspended under this clause, the Contractor shall deem to have included such incidents in his tender accordingly. The Contractor shall not be entitled to any extension of time and any loss and expenses incurred arising from such temporary suspension of the works.
- 9.14 Upon receiving feedback, the Contractor shall provide information with regards to works carried out during the period of time where the complaint was lodged and the additional mitigation measures implemented. This information shall be disseminated to the Engineer as well as to CSEP Division.
- 9.15 The Contractor's PRO shall follow up with complainant and the outcome of the engagement shall be reported back to the Engineer as well as to CSEP Division.

Noise Mitigation Measures (Source Reduction)

- 9.16 The Contractor shall ensure that excessive noise is avoided at all times to protect nearby residents/ occupants and site personnel.
- 9.17 The Contractor while preparing the programme for the Works, shall take into account the non-working restriction and the site layout in order to minimise noise for as far as possible, including but not limited to the consideration of using materials and other intermediate stages of construction such as noise barriers, etc.
- 9.18 While planning for the Works, the Contractor shall review the working hours and consider the effects of construction noise on personnel working in or around the site as well as the neighbourhood within proximity of the site. The Contractor shall take into account the nature of the land use in the area, duration of works and the effect of lengthening works period or other nuisances which may affect the neighbourhood.
- 9.19 Sensitive receivers shall be identified and mitigation measures implemented before work commences. The Contractor shall take all practicable measures as outlined in this Annex as well as SS 602 to reduce noise arising from site activities to a minimum.

- 9.20 The Contractor shall note that the construction equipment and methods of work which cause excessive noise will not be allowed to be used on site. The Engineer has the discretion to require the Contractor to take necessary precautions, whether specified herein or not, to maintain or to repair such construction equipment or to instruct their removal from site when it is determined that the noise level generated from the construction works fails to comply with regulations and standards as stated in this Annex. Machinery and equipment shall be enhanced acoustically as directed by the Engineer.
- 9.21 Where available, only sound-reduced machinery and equipment (as per manufacturer's specifications) are allowed to be used on site. Examples include:
- All compressors, generators, welding sets etc. shall be of sound reduced models fitted with properly lined and sealed acoustic covers which shall be kept closed whenever the machines are in use and all ancillary pneumatic percussive tools shall be fitted with mufflers or silencers of the type recommended by the manufacturer.
 - Rotary drills and busters actuated by hydraulic or electrical power shall, where practicable, be used for excavating hard material. Noisy construction plants, such as cement batching plant, shall be sited as far away as possible from occupied buildings with noise barriers erected, specifying the proposed location for the noise barriers.
 - Quieter soil dislodgement methods shall be adopted during bored piling, such as the use of modified auger bucket, auger cleaner, noise dampening Kelly bar etc. (as per Annex A-r).
 - Silencers, where practicable, shall be fitted at the end of the ventilation fan of the type recommended by the manufacturer.
- 9.22 It is the Contractor's responsibility to ensure that the machinery / equipment are maintained and operating to the standards indicated in their respective specifications.
- 9.23 Ventilation fan shall be housed in celcon block walls with built-in rock wool, unless otherwise counter-proposed with better acoustic alternative and subjected to the Engineer's approval. Due considerations for health and safety shall also be given for the usage of rock wool on site.
- 9.24 All machinery in intermittent use shall be shut down or throttled down to a minimum in the intervening periods between works.

- 9.25 The Contractor shall only use power supplied by PowerGrid. Where this is not possible, the Engineer may require that sound-reduced generator sets housed in acoustic sheds be used.
- 9.26 Care shall be taken when loading or unloading vehicles, dismantling scaffolding or moving materials to reduce impact noise. Access to the working areas shall be such as to ensure minimum disturbance to persons in occupied buildings. The Contractor shall not execute any of the works or carry out maintenance of construction plant in such a manner as to cause nuisance unless the work is absolutely necessary for the saving of life of property or for the safety of the works, in which case the Contractor shall immediately advise the Engineer.
- 9.27 No piling works will be allowed from 10pm to 7am unless both machinery and method are of a quiet nature (as substantiated by manufacturer's specifications and measured noise levels from a trial test where representatives from both the Contractor and the Engineer are present).

Noise Mitigation Measures (Barriers and Enclosures)

- 9.28 The Contractor shall take into account during design stage to avoid holes / gaps, etc. through or beneath the proposed noise barriers or full acoustic noise enclosures as these will affect the effectiveness of acoustic performance. Any damages to the noise barriers or acoustic enclosures during construction resulting in holes/gaps, etc. shall be repaired immediately.
- 9.29 Prior to the erection of full length perimeter noise barriers, temporary barriers with a minimum of Sound Transmission Class (STC) 18, unless otherwise justified to be non-implementable due to site constraint or safety reason to the Engineer, shall be used around noisy activities.
- 9.30 Full length noise barriers shall be erected at immediate site boundaries facing any affected buildings as stated in Environmental Protection and Management (Control of Noise at Construction Sites) Regulations as specified by NEA before work commences, unless otherwise justified and accepted by the Engineer. Such barriers shall have been tested to have a minimum of Sound Transmission Class (STC) 20, erected with a 45 degree cantilever extension at the top of the barriers as per Attachment A-11C. The detailed design will be issued to the Contractor after the award of Contract and upon the execution of a non-exclusive licence agreement with LTA and its collaborator. The barriers shall be at least 12m in height excluding the cantilever or break the line of sight from receiver to noise source. Lightning protection shall be provided.

- 9.31 Should the noise mitigation measures be deemed inadequate to meet the regulations, the Contractor shall provide additional measures to meet the regulations.
- 9.32 Noisy construction activities arising out of the Works that may exceed the construction noise permissible limits shall be barricaded with localised portable acoustic panels unless otherwise justified and accepted by the Engineer. Such panels shall have been tested to have a minimum of Sound Transmission Class (STC) 18. For piling rigs, a 2-layer localised noise enclosure with a cantilever extension shall be erected to cover the rotary head as per Attachment A-11C. The detailed design of the 2-layer localised noise enclosure with a cantilever extension will be released to the Contractor after the award of the Contract and upon the execution of a non-exclusive licence agreement with LTA and its collaborator.
- 9.33 All launch shafts, including muck pits, and slurry treatment plants shall be housed within a full acoustic enclosure (i.e. top-and-4-side covered), unless otherwise justified non-implementable due to site constraint/ safety reason or not facing any affected buildings as stated in Environmental Protection and Management (Control of Noise at Construction Sites) Regulations as specified by NEA and subject to the Engineer's approval. Where a full enclosure is not possible, an acoustic enclosure with the opened face oriented away from any residential / sensitive premises and covered with retractable acoustic rolling shutters shall be considered. Pipes transporting bentonite shall also be shielded by acoustic materials. Related works such as trucks removing tunnelling waste (slurry / muck) from site shall be carried out during daytime only, unless otherwise approved by the Engineer.
- 9.34 Full enclosures shall be of sufficient height and width to accommodate for machinery / equipment housed within it. It shall regard space requirements related to construction activities carried out within the enclosure and all considerations related to safety and health precautions. This includes but is not limited to: the latest Fire Safety Act and Fire Code issued by Singapore Civil Defence Force (SCDF) and Fire Safety and Shelter Department (FSSD).
- 9.35 The proposed full acoustic enclosures shall achieve noise level reduction by at least 10 db(A) when measured outside the noise enclosure and ensure that the noise level generated during construction works are within the permissible limits set out by the relevant authority.
- 9.36 The design of the full enclosure shall include, but not limited to the following elements: material, dimension and orientation of enclosure. The Contractor shall also specify details of the above factors in the Noise Management Plan (Attachment A-11a or A-11b) and submit to the Engineer for acceptance.

- 9.37 The layout of the full enclosures shall be designed to facilitate easy means of evacuation during emergencies with exit points clearly marked.
- 9.38 Highly flammable substances shall not be stored within the full enclosures.
- 9.39 Where possible, all permanent work areas shall be housed in an acoustic enclosure with the openings oriented away from any residential / sensitive premises.
- 9.40 Noisy activities such as bore piling works shall be barricaded with localised portable acoustic panels whenever possible.
- 9.41 Preparation for traffic diversion work must be carried out during the day and only the actual diversion will be allowed to carry out at night. Where activities have to be carried out at night (as approved by the Engineer), portable acoustic barriers must be set up in advance of such works. Residents must also be informed in advance of traffic diversion works.
- 9.42 For milling and patching works to be carried out at night, portable acoustic panels / enclosure must be deployed before commencement of such works.

Noise Measurement

- 9.43 The Contractor shall provide all necessary competent and qualified personnel and suitable equipment for all measurements and recordings of noise levels.
- 9.44 Locations of such noise measurements shall be at buildings likely to be affected by the construction works or as directed by the Engineer.
- 9.45 At any time during the Contract period as directed by the Engineer and after the project is completed and opened to traffic, the noise survey or part of it shall be repeated to establish any change in the noise levels.
- 9.46 The Contractor shall ensure that the baseline survey is representative of the baseline situation. Noise measurements taken for baseline survey will be required for buildings within 150m from the boundary of the construction site. Noise levels at buildings shall be measured 1m away from the nearest façade of the building facing the site and readings shall be taken from the location where the real time noise meters will be installed (typically at top storey) or as directed by the Engineer. Noise levels may also be required at locations other than buildings.

- 9.47 Noise measurements are to be taken at least 1.5m above grade without any obstructions / obstacles in the direction of measurement.
- 9.48 The Contractor shall install real time “live” monitoring devices to monitor the noise levels for the entire construction period, unless exempted by NEA. This system shall be equipped with a SMS “alert” feature when allowable limits are exceeded. Access to the system shall be made available to the Engineer.
- 9.49 In addition, the Contractor shall monitor the noise levels for the whole duration of noisy activities, night works and works carried out over the weekends using portable noise meters when the real-time noise meter is not available.
- 9.50 The real-time, baseline survey and portable monitoring devices shall be of Class 1 standard.
- 9.51 All machinery and equipment on site must have both the noise emission levels of: a) engine noise and b) operational noise under normal operating conditions, clearly indicated on a weather-proof sticker pasted at the side of the machinery. Such emission levels should be measured at source (1m to 3m away).

10. EARTH CONTROL MEASURES

- 10.1 The Contractor shall be responsible for preventing silt from being washed into public drains by implementing Earth Control Measures (ECM) for the construction site. The discharge into public drains shall not contain Total Suspended Solids (TSS) in concentration greater than the prescribed limits under Regulation 4(1) of the Sewerage and Drainage (Surface Water Drainage) Regulations.
- 10.2 The Contractor shall note that the ECM are for the containment and treatment of silty discharge due to the impact of rainwater. ECM are not meant for the treatment of wastewater due to construction activities (such as slurry from tunnelling, pipe-jacking and bore-piling works) which shall be treated to comply with the requirements under Environmental Protection and Management Act (Chapter 94A).
- 10.3 No earth works shall commence without adequate ECM facilities to ensure no discharge containing TSS in concentration greater than the prescribed limits under Regulation 4(1) of the Sewerage and Drainage (Surface Water Drainage) Regulations throughout the project, especially during the site clearance stage.
- 10.4 In his tender submission, the Contractor shall submit his schematic ECM plans of the construction site for the contract duration taking into account the different phases of construction activities, including site clearance. He shall also provide the name of the Qualified Erosion Control Professional (QECP) who will be endorsing the ECM plan after the tender is awarded.
- 10.5 These schematic ECM plans shall make the Contractor aware of the ECM requirements and the cost to implement an effective ECM. Notwithstanding the submission of these schematic ECM plans, the Contractor shall deem to have priced for the ECM in the contract sum.
- 10.6 Before construction works commence on site, the Contractor shall engage a QECP to plan and design the ECM, and he shall install the ECM according to the QECP's design.
- 10.7 The Contractor shall submit the ECM proposal duly endorsed by his QECP to the Engineer for comments. The comments shall be addressed before submitting to the relevant Authority for records. The ECM proposal shall consist and follow the format seen in Attachment A-12 and shall be submitted within three (3) months of contract award or as subjected to the Engineer's approval.
- 10.8 The Contractor shall ensure that their engaged QECP conduct monthly site inspection to verify ECM implementation and its effectiveness during construction and submit an ECM inspection report with the format specified in Attachment A-13 unless otherwise exempted by the Engineer.

10.9 For construction sites involving earthworks with site area of 0.5ha and above, the Contractor shall have an ECO with Earth Control Measures Officer (ECMO) qualification on site to ensure that the implementation, maintenance and inspection of ECM are in accordance to the QECP's design. The ECMO shall also monitor the effectiveness of ECM throughout the various stages of construction.

10.10 The Contractor shall also ensure that a Certificate of Clearance is obtained from PUB and the ECM be installed according to the endorsed plan before commencement of works.

10.11 During construction, the Contractor shall ensure the following measures are implemented on site, where applicable:

Erosion Control Measures

- a) Sequence and schedule of the earthworks / demolition works in stages and progressively with the subsequent construction activities and building works;
- b) Minimise site disturbance by keeping site clearance works to a minimum by retaining as much of the existing vegetation as possible;
- c) Pave up bare surfaces and all construction access by concrete or milled waste or other materials deemed suitable by the Engineer;
- d) Protect bare slopes with close-turfing, concrete grouting, erosion control blanket or canvas;
- e) Protect earth stockpiles with erosion control blanket or canvas;
- f) Restore ground cover over disturbed areas, which are or have become bare, as soon as possible;
- g) Carry out trench excavation work in sequence with the progress of permanent works to minimise impact on the environment;

- h) Identify the exposed bare surfaces and slopes for turfing or paving operation before the start of each phase of the project and restore ground cover over disturbed areas as soon as possible; and
- i) Implement the appropriate covers, such as vegetation, hardcore, milled waste, concrete and erosion control blanket, to minimise the extent of any exposed earth surfaces.

Sediment Control Measures

- a) Minimum C7 precast channel or concrete-lined cut-off drains shall be constructed within the construction sites;
- b) Silt fences shall be erected in front and along cut-off drains. The silt fence shall be embedded firmly into the ground and constructed from an approved geotextile filter fabric to capture the sediment from storm water runoff. The sediment built-up behind the silt fence must be regularly removed;
- c) Intermediate silt traps of suitable size shall be installed at regular intervals along the perimeter lined cut-off drain. Within the intermediate silt traps, suitable geotextile filter fabric or equivalents shall be installed across the full depth and width and / or coagulation-assistance materials shall be placed. Silt traps relying primarily on hardcore, granite chips or sands for filtration are not acceptable;
- d) The bio ball filtration system and / or other appropriate methods as approved by Engineer shall be used as part of the filtration system to control sediment;
- e) Sedimentation basin and / or storage pond/tank of adequate size and sufficient numbers shall be provided before treatment. It shall be minimum concrete lined and designed with storage capacity which complies with the design criteria specified in the Code of Practice on Surface Water Drainage;
- f) Suitable water treatment system / unit of adequate size and sufficient number shall be installed to treat only stormwater runoff before the discharge points into public drain;
- g) Water treatment system shall be equipped with a continuous, real-time, "live" monitoring of turbidity and TSS before any final discharge point and an on-line CCTV system at the public drain downstream of their final discharge outlet(s) to the public drain. This system should consist of a SMS "alert" feature when allowable limits are exceeded. The Contractor shall also submit the monitoring system proposal to the Engineer for acceptance. Access to the system shall be made available to the Engineer;
- h) The CCTV system shall comply with the Code of Practice on Surface Water Drainage under Regulation 4(2) of the Sewerage and Drainage (Surface Water Drainage) Regulations;
- i) The TSS monitoring meter shall be calibrated on a yearly basis.

- 10.12 As part of the maintenance regime, the Contractor shall monitor the TSS value of discharged water using a portable TSS meter and compare the reading against the value provided by the real-time TSS meter of the treatment plant to determine if it is working properly. This shall be recorded and made available upon request. The portable TSS meter shall be made available for ad hoc monitoring / upon request.
- 10.13 The Contractor shall ensure all excavated materials and spoils are removed from site by the end of the day.
- 10.14 The Contractor shall ensure the designed and installed ECM is continuously reviewed by the QECP for every stage of the construction and earthworks.
- 10.15 The Contractor shall maintain the ECM for the whole duration of the contract to ensure that it is effective at all times. Proper records detailing the maintenance works, supported by dated photographs, shall be kept by the Contractor for verification.
- 10.16 In the event that there is any accidental discharge of silty water, the Contractor shall immediately activate emergency response measures to prevent the spread and to clean up the affected area. If the silty discharge is discovered by the relevant enforcement authority (i.e. PUB), the Contractor shall follow the PUB-LTA Working Response Protocol Framework (specified in Section 6 of Attachment A-12) to provide prompt investigation reporting to the Engineer and PUB.
- 10.17 The Contractor shall not remove the ECM until all works are completed and upon the advice of his QECP. The Contractor shall inform PUB and the Engineer prior to removal of ECM on completion of the project.

11. TURBIDITY CURTAIN

- 11.1 For water bodies which are raw water sources for potable water and / or need for recreational purposes, high turbidity of the water in the water body will affect the treatment costs for potable water and / or the recreational use.
- 11.2 For works in such water bodies, turbidity curtains shall be installed. The works including the design, fabrication, and installation of the primary and secondary turbidity curtains shall ensure that the turbidity of water in the water bodies around the works shall not exceed the pre-existing levels or 50mg/l, whichever is greater.
- 11.3 The works in this Specification consists of all construction operations relating to the turbidity curtain. These construction operations include, but are not necessarily limited to the following:
- a) Design, manufacture, install and maintain primary and, if necessary, secondary turbidity curtain(s) around the areas of marine construction, either across the water body to enclose the entire work area, or individual curtains within / around / along the water body to enclose work areas;
 - b) Curtain(s) shall remain in place during excavation, installation of piles, foundations etc and backfilling works. The Contractor shall ensure that the curtain(s) is / are in good working condition for the duration of construction works. The turbidity curtain(s) shall not be removed until all operations have been completed and the water quality within the confines of the turbidity curtain meets the standards; and
 - c) The primary turbidity curtain shall be installed as specified. The secondary curtain(s) shall be installed as and when necessary to meet the requirements of these specifications.
- 11.4 The purpose of the curtain(s) is to meet the water quality standards by minimizing the transport of turbidity and other constituents generated by construction activities in the water body. This includes excavation, wet recovery of micro tunnel equipment, bentonite slurry use, tremie concrete operations, backfill and all other construction activities conducted in or near the water body. The turbidity curtain system shall provide sufficient residence time to allow soil or bentonite slurry particles to fall out of suspension, reduce turbidity, and meet the water quality standards.
- 11.5 Since it will require time to install additional, secondary turbidity curtain(s), the Contractor shall take turbidity measurements at specified distances from the edge of each outermost installed curtain to allow time to install secondary curtain(s) before the turbidity limit is exceeded.

- 11.6 The Contractor shall develop a plan to monitor the turbidity throughout the water column at three distances from the edge of each outermost installed turbidity curtain. Make initial measurements at a distance of 30m, 60m, and 100m from the edge of the primary curtain with turbidity measured at four (4) depths in the water column, then adjust distance and depth as appropriate based on direction of the plume, plume velocity, and the change in turbidity with distance from the work area. Initial measurement shall be made three (3) times a week.
- 11.7 The Contractor shall ensure the approved design of secondary curtain(s) is available before starting the excavation. Furthermore, for each area surrounded by a primary turbidity curtain, have at least one (1) secondary curtain available onsite and ready for installation after the turbidity limit is exceeded at a distance of 60m from the edge of the installed primary curtain.
- 11.8 The above requirements shall be met before construction activities begin.

Submission

- 11.9 Prior to manufacturing the primary and secondary curtain(s), submit the details of the primary and secondary curtain fabrication including:
- a) Material certifications and data on physical properties and ultraviolet resistance of permeable and impermeable curtain fabrics;
 - b) Shop Drawings for curtain and appurtenances;
 - c) Design analyses and calculations;
 - d) Installation plan and configuration;
 - e) Flotation and anchoring plan;
 - f) Maintenance plan;
 - g) Methods for providing entry and exit through curtain(s) as necessary for construction of all offshore work;
 - h) Manufacturer / Supplier qualifications; and
 - i) Profile of water body bed along curtain alignments.

Curtain Specifications

- 11.10 Primary Turbidity Curtain

- 11.10.1 Curtain Section: Curtain shall be a combination of permeable or impermeable materials. Curtain shall be heavy-weight, flexible, nylon-reinforced, polypropylene filter fabric, or flexible nylon reinforced thermoplastic as necessary to control turbidity created during construction, sewn into panels, hemmed, and edges finished to prevent raveling.
- 11.11 Secondary Turbidity Curtain(s)
 - 11.11.1 Curtain Section: As hereinbefore specified for primary curtain or as necessary to control turbidity in the vicinity of the construction.
- 11.12 Connectors
 - 11.12.1 Provide the curtain with appropriate galvanized steel snap hooks and rings for connecting load lines.
- 11.13 Flotation
 - 11.13.1 Provide a sufficient number of expanded polystyrene floats sufficient to keep the top of the curtain above the water surface with a minimum of 150mm of freeboard at all times.
- 11.14 Ballast and Anchorage
 - 11.14.1 Each curtain shall be equipped with a galvanized steel chain integrated into the bottom of the fabric to keep the curtain vertical and in contact with the bottom of the water body. Each curtain shall also be anchored to the water body bed to prevent excessive displacement from wind, waves and currents. The ballast, anchorage, and flotation shall be designed by the curtain manufacturer for the wind and wave conditions, bottom profile, and changes in water level. Anchors shall be spaced as necessary to secure each curtain and keep it stable in all conditions. Anchorage and/or flotation shall be designed to keep the top of each curtain above the water surface when subjected to wind or wave forces.
 - 11.14.2 Design, provide, and install shore anchoring where each curtain is attached to the shoreline. Design, provide, and install marine anchorages as necessary to secure each curtain.
- 11.15 Load Line
 - 11.15.1 Fit the curtain(s) with galvanized wire rope with vinyl coating of sufficient strength to resist all internal and external loading.
- 11.16 Oil Booms
 - 11.16.1 Oil booms, skimming devices, and pollution containment devices shall be provided as and when necessary to prevent contamination of the water.

11.17 Pre-installation Profile

11.17.1 Prior to manufacturing the curtain(s), develop a profile of the water body bed for each curtain location. Verify the depth of curtain, especially if the curtain is to be anchored to the shoreline to confirm the bottom profile at the exact location of curtain placement.

11.17.2 The curtain manufacturer shall use this information to dimension the curtain(s) with allowances for water level changes.

11.18 Curtain Design

11.18.1 The curtain and oil boom systems shall consist of a primary impermeable curtain, plus secondary curtain(s) as necessary to meet the water quality standards specified.

11.18.2 Each primary curtain shall have an impervious section that is full depth and is in contact with the bottom of the water body.

11.18.3 Each secondary curtain, if used, shall consist of an impervious section that extends up to a height as necessary to control turbidity.

11.18.4 Design each curtain for a useful life of at least the duration of the project.

11.18.5 Design curtain system for all temperature, wind, wave and current conditions at the project site as well as the anticipated varying water levels.

11.18.6 Design curtain system to meet the water quality standards.

11.19 Curtain Fabrication

11.19.1 Each curtain shall be manufactured / supplied by a specialty subcontractor with experience in turbidity curtain design and fabrication.

11.19.2 Design curtain to accommodate expected water level variations. If necessary, provide each curtain with additional longitudinal panels that can be added when the water level rises and with removable panels that can be pulled out when the water level drops.

11.19.3 Access Gate: Provide means for movement of equipment or materials through the curtain as may be required for operations.

Curtain Installation

11.20 Primary Curtain Installation

- 11.20.1 The exact locations shall provide sufficient working space compatible with the construction methods and also within the work limits of the contract. Install primary curtain before commencement of any works in or around the water.
- 11.20.2 Deploy the curtains in conformance with the manufacturer's recommendations.
- 11.21 Secondary Curtain Installation
 - 11.21.1 If the turbidity measured 60m from the primary curtain exceeds the water quality standards, install secondary curtain(s).
 - 11.21.2 Have the assembled curtain materials on site and install secondary curtain within 2 days of the day the turbidity exceeds the water quality standard.

Maintenance

- 11.22 Maintain, repair, and adjust the curtains as necessary throughout all construction activities.
- 11.23 Visually inspect the turbidity curtain(s) at least weekly. A written copy of the inspection report shall be submitted.

Curtain Removal

- 11.24 At the completion of all construction activities remove all turbidity curtains in their entirety. This includes all anchoring devices.
- 11.25 The Contractor shall not remove the curtains until the water inside the enclosed area meets the water quality standard.
- 11.26 The Contractor shall obtain approval before removing curtains.

ENVIRONMENTAL IMPACT REGISTER

Environmental Aspect	Description of Receptor		Description of Potential Impact		Proposed Mitigation Measures	Description of Residual Impact	Close Up Actions
	Receptor	Value/Sensitivity	Impact	Significance of Potential Impact	Summary of Mitigation Measures	Significance of Residual Impact	Close Up Actions
Category	Brief description of receptor	Very high/High/Medium/Low/Negligible	Brief description of impact	Major/Moderate/Minor/No Impact/Positive/Negative	Brief description of mitigation measures	Major/Moderate/Minor/No Impact	Brief description of close up actions
Water quality	Singapore River	Low	Degradation of receiving water body quality due to discharge of silt from site	Moderate Negative	Minimise bare earth surface areas to 0.1ha at any one time	Minor	Factored into Earth Control Measures (ECM) Plan, Document xxx. ECM plan to be reviewed when there is a change of phase in construction works.
Noise	Blk 51, 52 and 53	Medium	Noise disturbance to residents during construction works	Moderate Negative	Construct 10m noise barrier in front of the block	Minor	Noise barrier will be constructed in front of the blocks by 25 July 2015. Refer to Noise Management Plan Document xxx. NMP to be reviewed when there is a change of phase in construction works.

PS-A-165
ATTACHMENT A-7

CARBON ASSETS INVENTORY FORM

Carbon Assets Inventory

Contract No:	Year:
Main Contractor:	
Person Responsible of Compilation (Designation):	

Important:
To ensure accuracy, please refer to and familiarise with the instructions and definitions before inputting of values.
Contractor shall be responsible for the accuracy of the input. Any assumptions made for estimating purposes should be consolidated under the **Comments** tab.
Information requested covers all resources consumed within the physical boundary of the contract.

Offices		Units	ADMINISTRATION												Total	Comments		
			Jan	Feb	Mar	Apr	May	Jun	Jul	Aug	Sep	Oct	Nov	Dec				
1	Grid Electricity	kWh															0.0	
2	Water																0.0	
		PUB New Water	Litres														0.0	
		PUB Metered Water	Litres														0.0	
3	Refrigerant (Indicate type e.g. R-422a)	kg														0.0		
4	Fuel (for transportation within site only)	Diesel	Litres													0.0		
		Petrol	Litres													0.0		
		Biodiesel	kg													0.0		
		<i>If using alternative fuel, please indicate here:</i>														0.0		
5	Total No. of Persons in Site Office - Inclusive of LT A, GPS, Contractor Staff (for entire month) E.g. 5 persons x 20 (working days) = 100 person.days	person.days														0.0		
6	No. of days in operation/at work	no.														0.0		
7	Gross Floor Area	m ²														N.A.		

Machinery		Units	OPERATION												Total	Comments	
			Jan	Feb	Mar	Apr	May	Jun	Jul	Aug	Sep	Oct	Nov	Dec			
1	Grid Electricity	kWh														0.0	
2	Fuel	Diesel	Litres													0.0	
		Petrol	Litres													0.0	
		Biodiesel	kg													0.0	
		<i>If using alternative fuel, please indicate here:</i>														0.0	
Materials		Units	Jan	Feb	Mar	Apr	May	Jun	Jul	Aug	Sep	Oct	Nov	Dec	Total	Comments	
1	Water	PUB New Water	Litres												0.0		
		PUB Metered Water	Litres												0.0		
2	Asphalt	kg													0.0		
3	Mortar (Select mix ratio from drop down list below)	Mortar (1:4 Cement:Sand f	kg												0.0		
		Mortar (1:5 Cement:Sand f	kg												0.0		
															0.0		

PS-A-166
ATTACHMENT A-7

4	Ready Mixed Concrete																					
	Type: Ordinary Portland Cement																					
	Concrete (Below Grade 20)	kg																		0.0		
	Concrete (Grade 20)	kg																		0.0		
	Concrete (Grade 25)	kg																		0.0		
	Concrete (Grade 30)	kg																		0.0		
	Concrete (Grade 35)	kg																		0.0		
	Concrete (Grade 40)	kg																		0.0		
	Concrete (Grade 50)	kg																		0.0		
	Concrete (Above Grade 50)	kg																		0.0		
	<i>If using grades not listed, please indicate here</i>		kg																		0.0	
	Type: Portland Blast Furnace Cement																					
	Concrete (Below Grade 20)	kg																			0.0	
	Concrete (Grade 20)	kg																			0.0	
	Concrete (Grade 25)	kg																			0.0	
Concrete (Grade 30)	kg																			0.0		
Concrete (Grade 35)	kg																			0.0		
Concrete (Grade 40)	kg																			0.0		
Concrete (Grade 50)	kg																			0.0		
<i>If using grades not listed, please indicate here</i>		kg																			0.0	
Type: Others (please indicate: _____)																						
Concrete (Grade 20)	kg																				0.0	
Concrete (Grade 25)	kg																				0.0	
Concrete (Grade 30)	kg																				0.0	
Concrete (Grade 35)	kg																				0.0	
Concrete (Grade 40)	kg																				0.0	
Concrete (Grade 50)	kg																				0.0	
<i>If using grades not listed, please indicate here</i>		kg																			0.0	
5	Pre-Fabricated Concrete (Compulsory to provide in units of kg)	Concrete content	kg																		0.0	
		Steel content	kg																			0.0
6	Steel	Fabric Reinforcement	kg																			0.0
		Bar Reinforcement	kg																			0.0

		WASTE GENERATION														
		Units	Jan	Feb	Mar	Apr	May	Jun	Jul	Aug	Sep	Oct	Nov	Dec	Total	Comments
1	Site Office															
	Total Recycled Waste	kg	0.0	0.0	0.0	0.0	0.0	0.0	0.0	0.0	0.0	0.0	0.0	0.0	0.0	0.0
	Paper	kg														
	Glass	kg														
	Plastic	kg														
	Aluminium cans	kg														
<i>Other recycled waste (please indicate under comments):</i>		kg														

ATTACHMENT A-7

	Total Disposed Waste	kg	0.0	0.0	0.0	0.0	0.0	0.0	0.0	0.0	0.0	0.0	0.0	0.0	0.0	0.0	0.0
	General Construction Waste	kg															0.0
	<i>Other Disposed Waste (please indicate under comments):</i>	kg															0.0

SOLAR ENERGY																
	Units	Jan	Feb	Mar	Apr	May	Jun	Jul	Aug	Sep	Oct	Nov	Dec	Total	Comments	
1 Solar Energy Yield																
	Site Office (metered readings only)													0.0		
	Construction Site (metered readings only)													0.0		
	Site Office (non-metered readings only)													0.0		
	Construction Site (non-metered readings only)													0.0		
2 Solar Energy Sold Back to Grid (if applicable)	kWh													0.0		

ELECTRIC VEHICLES																
	Units	Jan	Feb	Mar	Apr	May	Jun	Jul	Aug	Sep	Oct	Nov	Dec	Total	Comments	
1 Electricity Consumption (if any)	kWh													0.0		

AIR POLLUTION CONTROL PLAN

The Contractor shall follow the following reporting format for the submission of the Air Pollution Control Plan. The proposed plan shall include but not limited to the required information as follows.

1 Project information

- Project title and description
- Project location and area

2 Air sensitive receivers

- This section shall include a map highlighting the locations and proximity of potential air sensitive receivers to the sources of air pollution from site.

3 Air pollution sources & controls

- List of all diesel-powered machineries including generators, excavators, piling machines etc., and the respective numbers used on site.
- List of all vehicles including dump trucks, lorry loaders etc., and the respective numbers used on site.
- List of all other air pollutants and dust producing activities such as welding, vehicles travelling on site, operation of slurry treatment plant, stockpiling, boring, hacking activities etc.
- Air pollution control measures for the above mentioned machineries, vehicles and activities shall be provided. Control measures shall be provided and implemented with the following order of hierarchy:
 - a) Elimination method (shall be used whenever possible);
 - b) Substitution;
 - c) Engineering; and
 - d) Administrative (shall be used only when the above methods are not reasonably practicable to implement or used in existence with the above methods)
- Attached inspection and maintenance regime for all fuel-operated vehicles, machineries, power-packs, generators, welding sets etc.
- Specifications, where applicable, for engineering methods shall be included, for example, type and size of dust netting, dust eating machines etc.

VECTOR CONTROL PLAN

The Contractor shall follow the following reporting format for the submission of the Vector Control Plan. The proposed plan shall include but not limited to the required information as follows.

1 Revision page

- List of revision
- Summary of revision

2 Project information

- Project title and description
- Project location and area
- Additional information on whether the site has pre-existing vector conditions and proposed surveillance and control measures prior to commencement of site clearance.

3 Site layout plan (with “zoning method”)

- Attach a site layout plan with indication of zones for vector control; and
- Identify vulnerable or potential breeding grounds such as designated storage area, waste skids, water tanks, ECM treatment plants, sedimentation ponds and sumps etc.

4 Vector control personnel

- In-house Pest Control Team
 - a) Organisation chart
 - b) Duty roster for surveillance and control activities which specifies day, time, zone, assigned worker and activities to be carried out
- Pest Control Operator
 - a) Details of Pest Control Company
 - b) Pest Control Company track record
 - c) Valid NEA license and certificate

5 Vector Surveillance and Control

- This section shall include, at minimum, the surveillance and control measures as specified in Clause 7 of Annex A-g.
- Vector surveillance and control checklist to be included. The Contractor may use the relevant form or checklist found in NEA’s website. The checklist is to be used for routine inspection and breeding grounds found with some descriptions shall be documented.

6 Response plan

- This section shall specify the measures to be taken in the event the site is in a dengue / zika cluster or when there is any person found on site to be a carrier of or contracted with any vector-borne disease.
- The response plan shall adopt the LTA Dengue Contingency Plan and reporting format as shown below.

	LTA Sites located within Dengue Clusters based on NEA Dengue Community Alert			LTA Sites with ≥ 10 Dengue Cases within 2 Consecutive weeks
	Green (No Active Cluster)	Yellow (Cluster of <10 cases)	Red (Cluster of ≥ 10 cases)	
Housekeeping	Daily	Daily	Twice Daily	Twice Daily
Search & Destroy by in-house vector team (3-zone method)	One zone daily	One zone daily	Daily for all zones	Daily for all zones
Mass carpet combing for the entire site	Weekly	Weekly	Twice weekly	Daily (till no new reported cases)
Pest Control Operator (PCO) visit for the entire site	Weekly	Twice weekly	Twice weekly	Daily (till no new reported cases)
Trimming of overgrown grass	Weekly	Weekly	Weekly	Weekly
Monitoring of mosquito population using Gravitrap	Weekly	Weekly	Twice weekly	Twice weekly
Monitoring & reporting of Dengue symptoms	-	Suspected patient to report	Compulsory daily temperature check*	Compulsory daily temperature check* and daily reporting to LTA
Applying of insect repellent (3 times daily)	-	Compulsory	Compulsory	Compulsory
Indoor Residual Spraying @CTQ/TLQ/TOLQ	-	Once a month	Twice a month	Twice a month

Figure 1: LTA Dengue Contingency Plan, follow up actions for dengue clusters

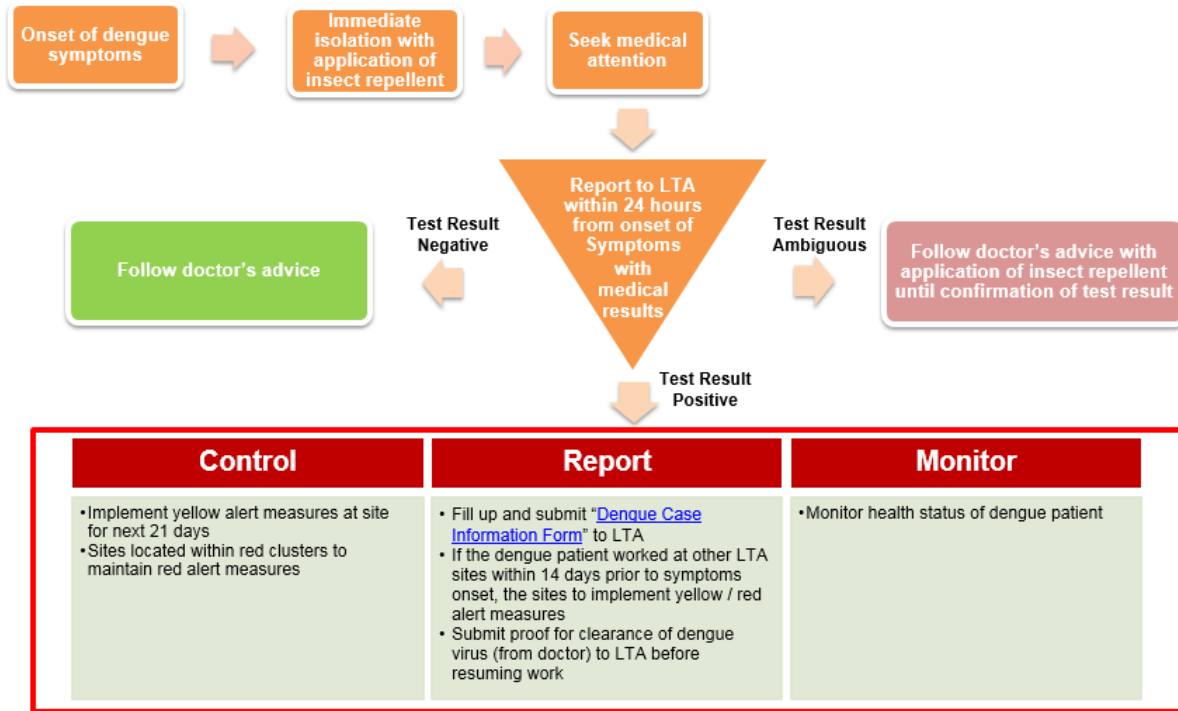

Figure 2: LTA Dengue Contingency Plan, actions required when there is onset of dengue / zika symptoms

DENGUE CASE INFORMATION FORM				LTA Contract No.		
Ref No.				LTA Officer-In-Charge & Contact No.		
Date Reported:				Contractor		
Date of 1st visit to doctor:				Contractor Officer-In-Charge & Contact No.		
Name of Clinic/Hospital:				Clinic/Hospital Address:		
Particulars	Name	NRIC/FIN/WP No.	Date Of Birth	Age	Nationality	
	Employer	Designation	Contact No.	Race	Country Of Origin	
Potential Location of Occurrence	Countries (cities) visited / lived prior to arrival in Singapore (if stay less than 2 weeks)				NEA Reported Dengue Cluster in past 2 weeks? (Y/N) and indicate alert level?	
	Residential Address (i.e. dormitory with block and room number or home address)				Yes <input type="checkbox"/>	No <input type="checkbox"/>
	Workplace Address (i.e. construction site); Work location (i.e. station, tunnel, storage yard)				<input type="checkbox"/>	<input type="checkbox"/>
	Other places have been to in the past 2 weeks (i.e. after working hours/off day)				<input type="checkbox"/>	<input type="checkbox"/>
	No. of working days per week		Working time		Day or Night shift (if applicable) 1-2 weeks prior to develop of dengue symptom	
	Mode of transport to work; Location of taking transport (if applicable)					
Symptoms	Symptom developed in past 1-2 weeks (i.e. fever, headache, body aches, joint pain, loss of appetite, nausea, vomiting and skin rashes)			Onset Date (DD/MM/YY)	Duration (Days)	Any Self -Treatment Taken? (Y/N)
	Blood Test	Date	Location of Clinic/Hospital of Blood Test Taken		Remarks	
	1 st					
	2 nd					
	3 rd					
	4 th					
Any co-workers from same worksite / dormitory with similar symptoms? Co-workers in close relationship with the patient? Please provide details of such individuals						
Date back to work:						

Figure 3: Dengue Case Information Form template

7 Training

- All relevant trainings for personnel involved in vector surveillance and control which include but not limited to:
 - a) Joint ITE-NEA Certificate in Pest Management for ECO or in-house pest control team supervisor;
 - b) Joint ITE-NEA Certificate in Pest Control for in-house pest control team; and
 - c) Trainings on understanding vector-borne diseases, identifying potential vector breeding grounds and measures to prevent the propagation of vectors for general workers.
- Dengue awareness or other vector awareness campaign to be conducted on site (indicating the proposed date)

WASTE MANAGEMENT PLAN

The Contractor shall follow the following reporting format for the submission of the Waste Management Plan. The proposed plan shall include but is not limited to the following:

1 Project information

- Project title and description

2 Site layout plan

- Brief write-up on the Contract: locations of station, alignment of tunnel, locations of launch shafts / escape shafts
- Site plans indicating site location for each construction phase, vehicular entrances, and proposed locations of waste management measures
- Should on-site wastewater treatment be proposed, separation of wastewater and surface runoff catchments, flow of wastewater, wastewater storage area and wastewater treatment plant shall be indicated on the site layout plan.

3 Waste management personnel

- In-house Waste Management
 - a) Organisation chart
 - b) Roles and duty roster for waste management activities
- Waste Collector
 - a) Details of all waste collector companies hired e.g. tunnel waste, general waste, construction waste, recyclable waste, sanitary waste and toxic waste
 - b) Track record of the above companies
 - c) Valid NEA licence and certificates
- Wastewater Treatment Solution Provider (if applicable)
 - a) Details of wastewater treatment companies
 - b) Track record of the above companies

4 Solid waste management and control

- This section shall include, at minimum, the solid waste management and control measures as specified in Clause 8 of Annex A-g.
 - a) Identification of all types of waste in accordance to the method of construction e.g. chemical, organic, wood, metal and construction waste.
 - b) Waste management procedures for waste reduction, waste segregation, recycling, and disposal.
 - c) Waste management and control checklist.
 - d) Initiatives to recycle/reduce e-waste and food waste (treatment to be considered before disposal).

5 Wastewater management

- This section shall highlight the measures for wastewater management which include:
 - a) Identification of wastewater sources (piling slurry water, concrete washout water, TBM tunneling wastewater, etc.);
 - b) Estimation of wastewater generated per day;
 - c) Process and procedures for minimising wastewater generation, managing wastewater at source, separating wastewater from surface runoff, disposing and/or treating wastewater (by waste collector or wastewater treatment provider).
 - d) Safety Data Sheets (SDS) of chemicals that will be used for treatment.

6 Testing of discharge quality

- Identification of watercourse type at treated trade effluent discharge point(s)
- Test schedule of treated trade effluent against the correct regulatory discharge limits at accredited laboratory on quarterly basis

7 Inspection and maintenance

- Inspection and maintenance schedules and checklists for all proposed wastewater containment and / or treatment facilities to be included

8 Response plan

- This section shall specify the measures to be taken in the event there is any contravention of the management measures or any unacceptable situation such as overflowing of skip bins, accidental discharge of untreated trade effluent, treatment system breakdown or waste into any watercourse or land.
- In the event where untreated trade effluent is discharged into watercourse and discovered by PUB, the Contractor shall follow the PUB-LTA Working Response Protocol Framework to provide prompt investigation reporting to authorities.

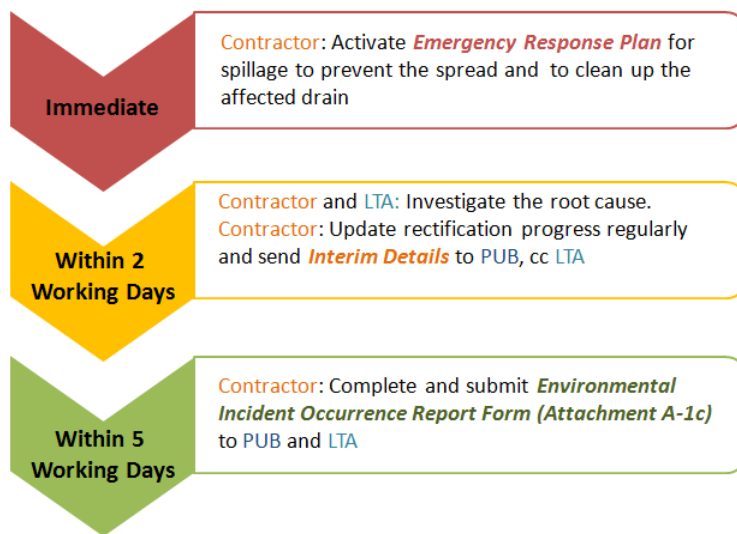

Figure 3: PUB-LTA Working Response Protocol Framework

**NOISE MANAGEMENT PLAN
(FOR CONTRACT SUM ≥ \$20 MILLION)**

The Contractor shall follow the following reporting format for the submission of the Noise Management Plan (for contract sum ≥ \$20 million). The proposed plan shall include but not limited to the required information as follows.

1 Revision page

- List of revision
- Summary of revision

2 Project information

- Brief write up on the contract: locations of station (top down / bottom up construction), alignment of tunnel (TBM / cut and cover) and locations of launch shafts / escape shafts
- Information on the types of buildings (whether residential / noise sensitive / business etc) and their height (2 storey shop houses / 20 storey office buildings / 12 storey apartment)

3 Acoustic consultant profile

- Relevant experience and track records

4 Work schedule

- Project work schedule (e.g. Gantt chart) including a breakdown of the various construction phases and their commencement date for the next 6 months (to be updated and revised regularly)
- Implementation schedule of the mitigation measures, according to the work schedule / construction phases/milestones

5 Identification of Noise Sensitive Receivers

- List of identified noise sensitive receivers and the respective characteristics
- Vulnerabilities of every identified receiver and the mitigation measures targeted to address these concerns

6 Baseline survey

- Results of the pre-construction noise readings / ambient noise levels recorded continuously over one (1) full week, using charts for easy reference
- Charts of the relevant leqs separately
- Actual readings in the appendix
- Proposed adjusted permissible noise limits for NEA approval

7 Noise simulation

- Noise simulation results and analysis from sound modelling software, such as CadnaA, SoundPlan or equivalent, in accordance to the respective construction phases (predicted noise levels before and after implementation of mitigation measures)
- Results in the form of noise simulation maps

8 Noise meters

- Calibration certificates of the noise meters for baseline survey, real-time noise meters and portable noise meters used
- Photos of the noise meters showing its fixed location and the orientation of the microphones

9 Noise mitigation measures for machinery and equipment

- List of machinery and equipment to be used on site
- Evidence that machinery and equipment to be used are sound-reduced models/ or operating using a quieter method from the manufacturers
- Noise emission levels of the machinery's engine noise and operating noise measured at source (1m to 3m away) for all machinery and equipment on site.
- Estimated noise levels at the receiver's end based on the worst case scenario (machinery and equipment at the shortest possible distance from the nearest affected building), using the formula in the SS 602 - Code of Practice for Noise Control on Construction and Demolition Sites.

- Noise mitigation measures (with details such as material, orientation, dimensions and shapes of acoustic enclosures) for each machinery and equipment that are likely to cause excessive noise at the receiver's end according to the respective construction phases.
- Noise emission levels of the machinery's noise and operating noise measured at source after implementation of noise mitigation measures
- Example of entry under this section:

Machinery / Plant / Equipment	Sound Reduced ?	Remarks	Noise emission levels at source (engine / operational) dBA	Shortest Dist to receiver (worst case scenario)	Estimated noise levels at receiver's end	Mitigation Measures required?	Final Noise Emission Levels at source (engine / operational) dBA
Bored piling rig Model XXX	N	No sound reduced model available	80/100	30		Yes, acoustic panels will be used to enclose the engine. In addition, portable noise barriers will be set up to shield the operation. Please see Appendix for photos of mitigation measures.	
Bored Piling rig Model YYY	N	No sound reduced model available	83/104	30		Yes, acoustic panels will be used to enclose the engine. In addition, coring bucket of the rig will be modified to refrain from "shaking": Please see Appendix for photos of mitigation measures.	
Generator set (PowerGrid supply not ready for now)	Y	Yes, please see appendix for manufacturer's specifications	55	30		No but low humming noise may be irritating to residents at night so generator set will be enclosed within a noise enclosure. Please see Appendix for photo of enclosure.	
Hacking tool model YYY	N	No sound reduced equipment available	120	30		Hacking to be carried out within an enclosure. No hacking works will be allowed during the evenings onwards till the next morning and during weekends.	

10 Noise mitigation measures for noisy areas / processes

- Specifications, such as height, length and acoustic material (sound transmission class) of all mitigation measures, e.g. full length perimeter noise barriers and full enclosures.
- Verified test reports of noise reduction ability of acoustic material
- Description of management system to track implementation schedule of noise mitigation measures
- List of noisy work processes and respective mitigation measures targeted at each noisy activity. Example:

Work Processes / Noisy area	Likely to cause nuisance to nearby residents?	Noise emission levels at source if applicable (dBA)	Dist to receiver	Estimated noise levels at receiver's end	Mitigation Measures	Final Noise Emission Levels at source (engine / operational) dBA
Rebar fabrication yard	Yes, especially during handling of rebar	76-78	50		To be sited at the furthest end from residences, please refer to site layout	
Permanent Works Area	Yes, machinery movement	80-83	30		To be enclosed within an acoustic enclosure as specified in LTA's GS. Please see Appendix for photos of acoustic enclosures	
Washing Bay	Yes, especially during the night	70-72	30		Noise barriers to be installed on hoarding next to the washing bay. Please see Appendix for photo of noise barrier at washing bay	
Slurry Treatment Plant	Yes, desanding operation is noisy	85-90	40		To be situated within a full acoustic barrier as per LTA's GS. Please refer to Appendix for photo.	

11 Public relation efforts

- Names and contact details of Public Relations Officer (PRO) and list of personnel that will manage feedback and investigative works
- Samples of circulars / publications / notice that will be distributed to residents / stakeholders
- Frequency of meet-the-residents sessions with specific dates, venues, invited guests and the target audience
- Description of the intended proceedings for each of these sessions

12 Feedback management

- Organisation chart including the roles and responsibilities of the PRO and the Contractor PM
- Process of feedback management
- Documentation of feedback, complaints and stop-work orders received

13 Site layout

- Site location, tunnel alignment and the surrounding buildings within 150m from the boundary of the construction site
- Locations of site offices / canteen, silo, wash bay, workers' rest area, rebar fabrication area and location of vehicular access.
- Locations of permanent acoustic enclosures (e.g. slurry treatment plant, launch shafts, permanent work areas) and locations of all temporary / permanent noise barriers, incorporating recommendations by the appointed acoustic consultant. The map must indicate the targeted dates of completion of each temporary / permanent noise mitigation measure.
- Noise sensitive receivers within 150m of site
- Location of real-time noise meters

14 Response plan

- List in detail the plan for heightened mitigation measures and public engagement should there be unavoidable noisy works predicted to exceed the regulatory noise limits

**NOISE MANAGEMENT PLAN
(FOR CONTRACT SUM <S\$20 MILLION)**

For projects <S\$20 million or of work nature that is considerably small scale, a basic Noise Management Plan may be prepared. The proposed plan shall include but not limited to the required information as in Attachment A-11a, unless otherwise stated.

- 1 Revision page**
- 2 Project information & Site layout**
- 3 Work schedule**
- 4 Baseline survey**
- 5 Identification of Noise Sensitive Receivers**
- 6 Noise mitigation measures**

Work Activity	Noise Sensitive Receiver	Type of noise (E.g. Drilling, knocking, scraping etc.)	Mitigation Measures
<i>E.g. Installation of handrails</i>	<i>E.g. Blk 110 residents</i>	<i>E.g. Drilling</i>	<i>E.g. Scheduling work during day time</i>

- 7 Public engagement efforts**

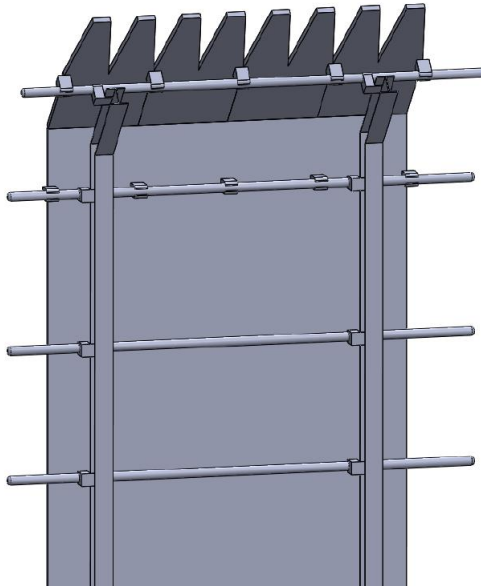

Indicative design of jagged edge flat-tip barrier

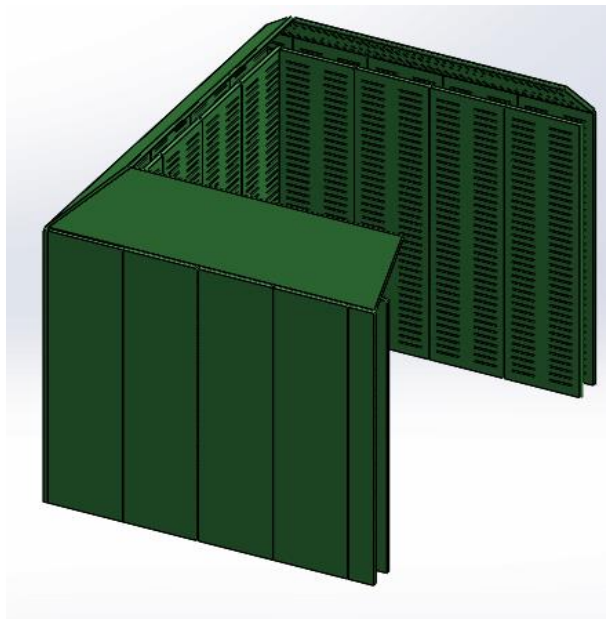

Indicative design of 2-layer noise panel

EARTH CONTROL MEASURES PLAN

The Contractor shall follow the following reporting format for the submission of the Earth Control Measures Plan. The proposed plan shall include but not limited to the required information as follows:

1 Revision page

- List of revision
- Summary of revision

2 Project information

- Name and address of site occupier
- Name and address of QECP for the project
- Name of ECO and ECMO (if applicable)
- Certification of QECP and ECMO (if applicable)
- Project title and description
- Site area and project duration
- Sequence of work, type and duration for each phase of construction activities

3 Detailed information of ECM Plan

This section shall concisely provide the erosion and sediment control measures to be used for different phases of construction activities, such as site clearance and foundation, taking into consideration of all potential controls described in Annex A-g Clause 10. Layout plans for various phases of construction activities shall be provided, showing the following information:

- Key/location plan showing the proposed site in relation to main roads and including any special landmarks or features;
- Boundary line of proposed development;
- Proposed phasing of work;
- Proposed outlet discharge points, CCTVs, TSS monitoring systems;
- Direction of surface runoffs into the proposed internal temporary drains;
- Direction of flow for all existing and proposed drains;

- Direction of flow for runoffs upstream and adjacent to the site and clearly indicate how they are effectively drained or diverted away;
- Description and location of each proposed erosion and sediment control measures, including silt fence, bund walls, perimeter drains, internal drains, sedimentation tanks, treatment system, CCTVs, TSS monitoring system, stockpile area, vehicle access route, wash bays etc;
- Specifications and catalogues of proposed erosion and sediment control measures;
- Indication of area of bare earth surfaces, where the surface runoff is expected, in m² on the plan;
- Indication of areas where bare earth surfaces are covered with concrete, milled waste, erosion control blankets, etc in m² on the plan; and
- Implementation schedule of all the mitigation measures, according to the work schedule/construction phases/milestones.

4 ECM calculations

- Calculations of soil loss / sediment yield
- Hydraulic calculations for the proposed temporary drainage system, silt traps, sedimentation tanks and size / capacity of storage ponds/tanks
- Calculations for the required and designed capacity of treatment units

5 Inspection, maintenance and monitoring of ECM

- Inspection schedule, checklist and maintenance schedule to be carried out by the Contractor for all proposed erosion and sediment control measures

6 Response plan

- This section shall specify the emergency response measures to be taken in the event there is any accidental discharge of silty water out of the site.
- In the event where silty discharge into watercourse is discovered by PUB, the Contractor shall follow the PUB-LTA Working Response Protocol Framework to provide prompt investigation reporting to authorities.

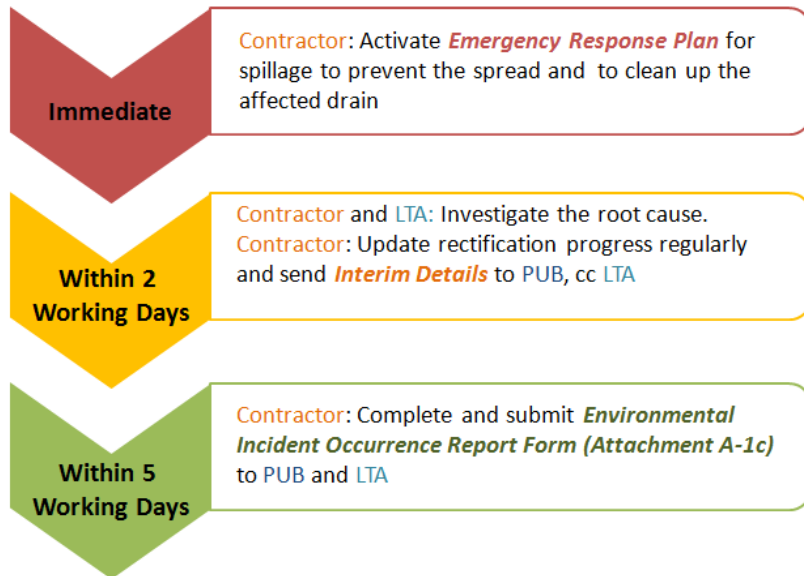

Figure 4: PUB-LTA Working Response Protocol Framework

Requirements for QECP Inspection Report

The QECP Inspection Report should identify good practices and areas for improvement on site. The following outlines the documented information requires to be submitted as part of the QECP's monthly site inspection for LTA sites. It consists of three attachments, with their requirements elaborated below.

1. QECP Inspection Checklist

The QECP inspection checklist should be duly filled. A sampleⁱ is as shown in Attachment 1.

2. ECM Layout Plan

The ECM Layout Plan should be updated according to the current stage of works, and it should show accurate information of the ECM being implemented. It should include:

- Date of ECM plan
- QECP's endorsement
- Site layout plan with locations and specifications of all ECM facilities clearly indicated:
 - a) Perimeter drains
 - b) Sedimentation/holding ponds
 - c) Silt traps (if any)
 - d) ECM treatment plants
 - e) Stockpiles (if any)

The site layout plan should also indicate locations where site photos are taken. A sample is as shown in Attachment 2.

3. Inspection Photos

All ECM facilities shall be inspected, and photography records should be provided. Site photos should be taken from an angle that is representative of the actual site condition. Photos taken should not be limited to just areas for improvement, but should also include good practices or areas with good maintenance. A sample is as shown in Attachment 3.

ⁱ The sample is extracted from the Guidebook for QECP

Date of Inspection:
Name of Inspecting Officer:
Appointment
Date & Time of Site Visit:
Weather Condition:

Project Title:
Location of Site :
Project Duration:
Type of Present Construction Activity:
PUB Permit Number:

Owner / Developer:
QP for Project:
QECP for ECM:
ECO:
Owner / Developer's Representative on-site:

Date of ECM Plan:
Last Date of ECM Plan Review:

ADDITIONAL INFORMATION
Date & Time of Previous Site Visit:
Date Of Last Inspection Report:
Issues Identified In Previous Site Visit:

This site inspection has been certified by:

QP / QECP:
Signature:
Date:

Contractor:
Signature:
Date:

Owner/Developer:
Signature:
Date:

Note: Earth Control Measures is for the treatment of silty water due to rain water. Construction wastewater (slurry, bentonite..etc) due to tunnelling, boring..etc shall be separately treated.
--

S/N	BEST MANAGEMENT PRACTICES	INSPECTION	COMPLIANCE	ACTIONS
1	Construction Sequence & Scheduling	Clearing of construction areas carried out in phases?	Yes / No / NA	
2	Stockpiles of Earth Materials	Stockpile location according to ECM plan?	Yes / No / NA	
3	Stabilization through laying of milled waste, lean concrete, turfing ...etc	Location according to ECM schedule?	Yes / No / NA	
		Construction according to ECM details?	Yes / No / NA	
		Any signs of damage at lean concrete areas?	Yes / No / NA	
		Any signs of damage at milled waste areas?	Yes / No / NA	
		Any signs of damage at turfed areas?	Yes / No / NA	
4	Stockpiles of Earth Materials	Stockpile location according to ECM plan?	Yes / No / NA	
		Protected against erosion?	Yes / No / NA	
		Protected against sedimentation?	Yes / No / NA	
5	Silt Traps	Installation of silt traps including location according to ECM schedule?	Yes / No / NA	
		Installation of silt traps according to ECM plan including no.s & size?	Yes / No / NA	
		Silt Traps damaged?	Yes / No / NA	
6	Sedimentation Basins / Storage Ponds	Installation of basins / ponds including location according to ECM schedule?	Yes / No / NA	
		Installation of basins / ponds according to ECM plan including no.s?	Yes / No / NA	
		Concentration of TSS in effluent (outlet of discharge) < 50mg/l?	Yes / No / NA	
		Sediment filled to within 300mm of water discharge level of outflow structure?	Yes / No / NA	
		Sedimentation basins inlet / outlet choked?	Yes / No / NA	
		Protected against sedimentation?	Yes / No / NA	
7	Treatment Units / Polymer Blocks	Treatment unit(s) in operation?	Yes / No / NA	
		Polymer blocks used / adequate?	Yes / No / NA	
8	Perimeter cut-off drains	Installation of cut-off drains including location according to ECM schedule?	Yes / No / NA	
		Installation of cut-off drains according to ECM plan including lengths?	Yes / No / NA	
		Cut-off drain lined?	Yes / No / NA	
		Any signs of inadequate capacity? (flooding)	Yes / No / NA	
		Any obstruction / sediment?	Yes / No / NA	
		Any signs of damage?	Yes / No / NA	
9	Wheeled wash areas, entry/exit points	Location according to ECM plan?	Yes / No / NA	
		Construction according to details?	Yes / No / NA	
		Any signs of damage?	Yes / No / NA	
		Run-off (from wheeled wash areas) and overflow / discharge channeled to suitable areas for proper treatment?	Yes / No / NA	
		Any signs of silty water from these areas into public drains (drains / roads / etc)?	Yes / No / NA	
10	Others	Any areas without/inadequate ECM?	Yes / No / NA	
		Public drains at discharge points silted?	Yes / No / NA	
		Public drains in vicinity of site silted / obstructed?	Yes / No / NA	
		Run-off from site not channeled through silt fences / cut-off drains / silt traps?	Yes / No / NA	
		Any discharge of water into public drains?	Yes / No / NA	
		Earth surfaces / slopes adjacent to any drain not turfed, paved or covered?	Yes / No / NA	

Any other observations / comments:

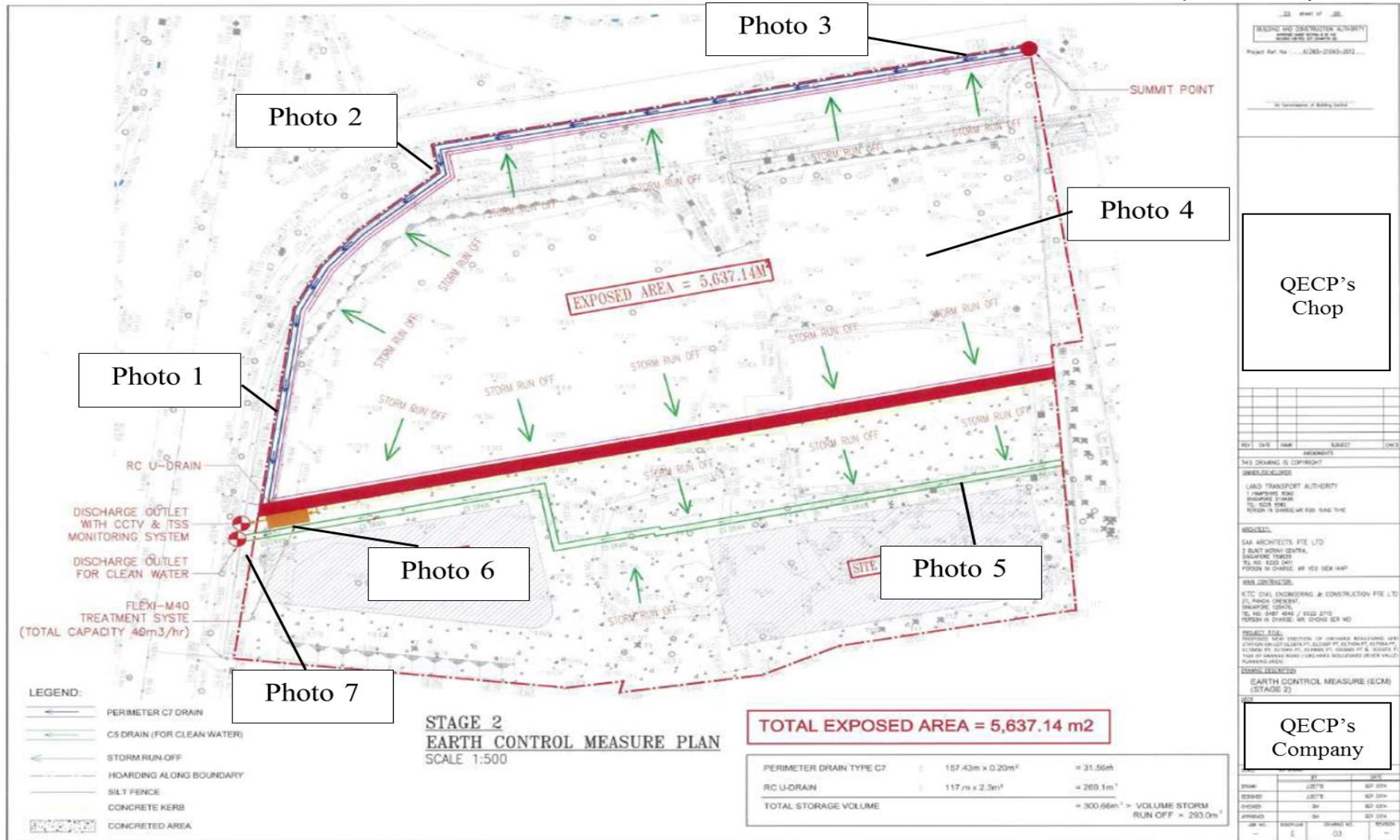

Attachment 3 – Sample Inspection Photos

Observation	Close-out Action
Perimeter Drains	
<p><u>Photo 1</u></p>  <p>Observation: Perimeter drain and silt fence are well-maintained</p>	<p>N.A.</p>
<p><u>Photo 2</u></p>  <p>Observation: Perimeter drain is silted, and concrete lining is damaged</p> <p>Recommendation: To clear the silt and repair the damaged section of the drain</p>	

Attachment 3 – Sample Inspection Photos

Photo 3



Observation: Perimeter drain is not constructed according to the specifications in the ECM plan.

Recommendation: To increase the depth of the perimeter drain and ensure that it is constructed according to the specifications stated in the ECM plan.



Photo 4



Observation: Perimeter drain is well-maintained.

N.A.

Attachment 3 – Sample Inspection Photos

Stockpiles	
<p><u>Photo 5</u></p>  <p>Observation: Earth stockpile is adequately covered</p>	<p>N.A.</p>
Sedimentation Ponds	
<p><u>Photo 6</u></p>  <p>Observation: Sedimentation pond is heavily silted</p> <p>Recommendation: To clear the silt and ensure that the capacity of the sedimentation pond is not compromised.</p>	

Attachment 3 – Sample Inspection Photos

ECM Treatment Plants

Photo 7



Observation: TSS meter is errant with reading of -10mg/L

Recommendation: To engage the supplier and rectify the technical error

Closed out by: _____ Signature & Date: _____
(Contractor)

Verified by: _____ Signature & Date: _____
(LTA Project Team)

BIODIVERSITY**1. GENERAL**

- 1.1 This section is only applicable to contracts with a Biodiversity Impact Assessment (BIA) conducted for their construction work.1.2 The Contractor shall adhere to and implement the recommended mitigation measures outlined in the BIA.

2. BIODIVERSITY MONITORING AND MANAGEMENT PLAN

- 2.1 The Contractor shall submit a Biodiversity Monitoring and Management Plan as specified in the BIA and submitted to the Engineer for approval within three (3) months of contract award or as subjected to the Engineer's approval.2.2 During construction, the Contractor shall include but not limited to the following implementation measures on site:(a) Use environmentally-friendly methods for vector control such as Bti and search & destroy operation etc. instead of anti-malaria (AM) oil, or chemical larvicides;
- (b) Use sound reduced machines prior to entering the site;.
 - (c) Barricade noisy activities with portable sound barriers or panels;.
 - (d) Lightings would affect nocturnal animals. When lighting has to be used, refrain from pointing the glare towards habitats. Lightings shall be directed downwards where work is carried out;.
 - (e) Site utilization plans shall consider preservation and protection of native trees as far as possible. Tree or shrubs that can be preserved and protected shall be identified with methods to prevent harm to the tree, branches and roots. (Refer to NParks Conservation of Trees and Plants Guideline for reference);.
 - (f) Preventive measures to ensure no trade effluent, chemical, diesel or silt discharges into nearby water bodies. (Refer to Annex A-g Section 6 and 10 for more details).

FLOODING**1 General**

- 1.1 The Contractor has to take into consideration of possible flooding to the Works during construction stage. This shall include provision of flooding protection measures for existing underground Rapid Transit System (RTS) and / or existing underground road tunnels before any opening is made into the existing RTS below the specified flood protection level. The Contractor shall consider the risks of flooding due to nature or arising from the construction activities.
- 1.2 The Contractor shall submit, within two (2) months of the award of the Contract a comprehensive flood protection plan for the whole of the Works. In preparing this plan, the Contractor shall carefully examine the surrounding topography to determine the probable nature and extent of any flooding. Where relevant the Contractor shall also consider in his plan the possible adverse effects of wind and tides and the risk from adjacent tunnel contracts.
- 1.3 The plan shall identify the areas that are at risk from flooding. The plan shall examine the potential consequences of any flooding and shall make proposals to prevent flooding.
- 1.4 The flood protection measures provided shall comply with the requirements of “Code of Practice on Surface Water Drainage” for “Flood Protection of Underground Rapid Transit System” issued by the PUB (Drainage) Department. When considering rainfall intensity the Contractor shall use a storm return period of not less than 100 years. A suitable Runoff Coefficient shall use a storm return period of not less than 100 years. A suitable Runoff Coefficient shall be used but shall not be less than 0.90 (urban areas fully and closely built up) without the written acceptance of the Engineer.
- 1.5 When pumping is proposed, the Contractor shall address the following:
- a) operating procedures;
 - b) provision of a secure power supply and back-up;
 - c) automation and/or reaction time required to start the pumps; and
 - d) method and arrangement of discharge.
- 1.6 Shafts shall be surrounded by topography sloping away from shaft to direct rain water to a drainage channel. Shafts shall be equipped with a minimum of two (2) dewatering lines per shaft to ensure effective drainage in case of blockage.

- 1.7 The Contractor shall conduct checks on the flood protection measures and areas that are at risk from flooding, and submit a flood prevention checklist with the format specified in Attachment A-14

2 Flooding Evacuation and Rescue Procedure

- 2.1 The Contractor must make adequate safety provisions in the event of flooding whether it is due to inclement weather or the bursting of river bank in order to minimise the loss of life and property damage, where practicable.
- 2.2 The safety provisions to be put in place shall not only be limited to the providing of an emergency evacuation and rescue plan, trained rescue teams and water rescue aids or equipment. The trained rescue team and emergency procedure shall be in place before the start of any work. The number of trained rescue teams and water rescue aid or equipment shall be increased when deemed necessary by the Engineer or his Representatives. The water rescue aids or equipment shall be properly maintained throughout the lifetime of the project.
- 2.3 Emergency drills shall be conducted every six (6) months with the involvement of Singapore Civil Defence Force where necessary.

FLOOD PREVENTION CHECKLIST
PROJECT: XXXXXXXXX / ZONE: XXXXXX

DATE / TIME OF INSPECTION :

INSPECTED BY (NAME/SIGN) : _____

	Locations (Based on Inventory)	Daily Inspection/During Rain		After Rain	
		Monitor	Actions Taken	Inspection	Actions Taken
Risk Level 1 (Daily Inspection or First 30 Mins of Rain)	Public Area	Pedestrian Walkway	- Signs of ponding - Signs of overflows - No obstruction to water flow - Any trees/branches fell?		- Signs of ponding - Signs of overflows - No obstruction to water flow - Any trees/branches fell?
		Bus Stops			
		Drop Inlet Chamber & Connection to Drain			
		Base of Concrete/Water-filled Barricades			
		Roadside Drain			
		Major Drain			
		Road Side Table			
		Road Junctions			
		Any changes to approved drain design?			
	Within Site	Perimeter Drain			
		Bund Wall to Excavated Area			
		Water Pumps in good working condition			
		Any changes to approved drain design?			
		ERSS Crest min. 1m above ground			

FLOOD PREVENTION CHECKLIST
PROJECT: XXXXXXXX / ZONE: XXXXXX

DATE / TIME OF INSPECTION :

INSPECTED BY (NAME/SIGN) : _____

	Locations (Based on Inventory)	Daily Inspection/During Rain		After Rain		
		Monitor	Actions Taken	Inspection	Actions Taken	
Risk Level 2 (Next 30 Min of Rain)	Public Area	Pedestrian Walkway	- Signs of ponding - Signs of overflows - No obstruction to water flow - Any trees/branches fell?		- Signs of ponding - Signs of overflows - No obstruction to water flow - Any trees/branches fell?	
		Bus Stops				
		Drop Inlet Chamber & Connection to Drain				
		Base of Concrete/Water-filled Barricades				
		Roadside Drain				
		Major Drain				
		Road Side Table				
		Road Junctions				
		Any changes to approved drain design?				
	Within Site	Perimeter Drain				
		Bund Wall to Excavated Area				
		Water Pumps in good working condition				
		Any changes to approved drain design?				
		ERSS Crest min. 1m above ground				

FLOOD PREVENTION CHECKLIST
PROJECT: XXXXXXXXX / ZONE: XXXXXX

DATE / TIME OF INSPECTION :

INSPECTED BY (NAME/SIGN) : _____

	Locations (Based on Inventory)	Daily Inspection/During Rain		After Rain		
		Monitor	Actions Taken	Inspection	Actions Taken	
Risk Level 3 (Subsequent Every 30 Min Rain)	Public Area	Pedestrian Walkway	- Signs of ponding - Signs of overflows - No obstruction to water flow - Any trees/branches fell?		- Signs of ponding - Signs of overflows - No obstruction to water flow - Any trees/branches fell?	
		Bus Stops				
		Drop Inlet Chamber & Connection to Drain				
		Base of Concrete/Water-filled Barricades				
		Roadside Drain				
		Major Drain				
		Road Side Table				
		Road Junctions				
	Any changes to approved drain design?					
	Within Site	Perimeter Drain				
		Bund Wall to Excavated Area				
		Water Pumps in good working condition				
		Any changes to approved drain design?				
		ERSS Crest min. 1m above ground				

MARINE WORKS**1 General**

- 1.1 Marine structure is defined as any temporary or permanent structure constructed in open water, on the foreshore or in rivers where some part or all of the structure is exposed to the water. Marine work is work on or within a marine structure either during its construction or installation or thereafter.
- 1.2 The Contractor shall ensure that all relevant requirements of marine safety legislation are complied with and shall liaise with the appropriate officers of the Maritime and Port Authority of Singapore (MPA) for necessary permissions for work being carried out in waters which come under their jurisdiction.
- 1.3 The Contractor shall liaise with the Building and Construction Authority (BCA) with respect to the impact of building materials.
- 1.4 The Contractor shall also ensure that all relevant requirements of environmental legislation are complied with and shall liaise with the appropriate departments of National Environment Agency (NEA).
- 1.5 Navigational aids (inclusive of lights and beacons) shall be fitted at appropriate positions as required by marine safety legislation and they shall be maintained in efficient working order. Navigational and other warning lights shall function throughout all hours of darkness or of reduced visibility.
- 1.6 Pre and post condition sonar surveys with runs at five (5) metre intervals or closer shall be carried out by a hydrographic surveyor approved by MPA. Results of the survey shall be submitted to the Engineer and MPA. Any high spots, levels or sunken object found in the post condition sonar surveys that were not observed in the pre-condition sonar survey shall be removed to the satisfaction of the MPA.
- 1.7 Before starting of any marine works and upon its completion, the Contractor shall ensure appropriate notices to mariners and other port users are issued by the Port Master's Department of the MPA including the payment of necessary fees.
- 1.8 The Contractor shall ensure that lifting machines inclusive of barge mounted cranes, lifting appliances and lifting gears on board of any vessel used for lifting operations in connection with this Contract shall comply with the "lifting operation" annex of this general specification.

- 1.9 All floating barge / pontoon mounted plant shall be secured against accidental displacement and the barge / pontoon anchored to minimise movement due to the drag of the current etc.
- 1.10 At night the waters surrounding any barge / pontoon in which any form of work is being carried out shall be effectively illuminated to a surface distance of 10 metres away.
- 1.11 All reasonable measures shall be taken by the Contractor to prevent workers from falling into the water. All persons working near the edge of docks, wharves or similar structures, or on board a vessel or barge mounted crane shall be provided with and shall wear a suitable life jacket.
- 1.12 Where any work is being carried out on or near water suitable life buoys with sufficient length of life line shall be placed at strategic points for rescue purposes. The Contractor shall provide a standby emergency boat at a location approved by the Engineer.
- 1.13 The Contractor shall ensure that vertical ladders which afford a means of escape for a person from the water to a safe place are fixed to the outer surface of any marine structure or vessel on which work is being carried out and maintained in an acceptable condition.

2 Design, Installation and Dismantling of Marine Structures

- 2.1 The design of the marine structure shall take into account the maximum possible tidal range and flow, effects of flooding or other works upriver if appropriate, the wash caused by passing vessels and predicted wave height in the worst foreseeable weather conditions. In determining these maximum water levels the Contractor shall consult relevant tidal charts and tables for the intended location of the marine structure.
- 2.2 The design of marine structures should also take into account the impact load due to the berthing force of vessels, barges, etc.
- 2.3 The Contractor shall ensure that the marine structure is designed by a PE and such design shall be subject to approval by both NEA and MPA. The PE shall supervise its construction and certify the structure as being in compliance with his design and calculations before the marine structure is first taken into use.
- 2.4 The PE shall specify the method by which the marine structure is to be located in position, if it is pre-fabricated, and shall supervise closely its being placed there. This work shall be carried out by persons having adequate previous experience of similar work, or by persons under the close control of supervisors who have such experience. The marine works shall be supervised by a dedicated and qualified supervisor.

- 2.5 If assembled in-situ, only competent workers are to be used, and appropriate precautions must be taken to ensure the safety of those persons engaged in such work.
- 2.6 Alterations or modifications proposed to the marine structure shall be planned and designed by a PE subject to the approval of the Engineer. The PE shall subsequently certify that such works have been carried out in accordance with his designs and calculations before being taken back into use.
- 2.7 A method statement containing relevant safety requirements shall be generated by a PE together with a risk assessment for the installation, dismantling and subsequent removal from site of the marine structure and this shall be approved by the Engineer before any such work takes place.
- 2.8 All temporary marine structures erected shall be dismantled and removed on completion of the works.

3 Working Platforms

- 3.1 Where a person is required to work above water, proper working platforms in compliance with Scaffold Regulations shall be provided. They shall be maintained in position along all open sides of the platforms and any associated means of access except the parts where it is necessary for this edge protection to be removed for the work in progress.
- 3.2 If required by the Engineer safety nets shall be placed under any working platform over water, at a sufficient height to prevent a person coming into contact with the water taking into account the maximum tidal range.
- 3.3 No-one shall carry out any work over water from a temporary work platform unless he is wearing a safety harness which is secured by a lanyard to a fixed point or lifeline which has first been inspected and authorised by a Safety Supervisor as safe for use. Such authorisation shall be recorded in writing in a register kept for that purpose.
- 3.4 Barges and pontoons and similar which are used as working platforms shall be properly constructed and sufficiently stable to avoid tipping. All persons working on them shall wear appropriate buoyancy aids and be instructed in what action to take in the case of any capsize or man overboard. Each shall have an appropriately stocked first aid box on board.

4 Water Transport

- 4.1 Persons may only be transported across water to their work locations only in vessels certified by MPA. All persons carried on board as passengers must be seated throughout the crossing and the vessel may only carry the approved number of passengers. If materials are carried in addition to passengers, the vessel must not be overloaded. Operators of these vessels shall hold a valid MPA license to operate.
- 4.2 The vessel must be equipped with the scheduled number of suitable life-saving appliances according to its capacity and these should be maintained in a satisfactory condition.
- 4.3 No smoking shall be permitted on board the vessel.
- 4.4 The embarkation and disembarkation points for passengers at the land side and at the work location shall be fitted with hand rails and mid rails and shall be designed to make access safe during all tidal and weather conditions. Grab ropes shall be fitted near the waterline at all such locations and lifebelts provided and maintained close to the edge.
- 4.5 When not engaged in the transportation of passengers the vessel shall be on standby for rescue and other emergency purposes.
- 4.6 The Contractor shall make available a vessel together with operator with a seating capacity of not less than six passengers to enable LTA site staff to carry out inspections of the marine works at any time during the working hours of the Contract.
- 4.7 All barges, pontoons, vessels and similar used for transporting materials to the work locations for whatever reasons shall be certified by MPA. All persons who work on board shall be subject to the site rules and regulations of the Contractor and shall take part in such safety activities, co-ordination meetings and briefings as are required under the Contractor's Safety Management System.
- 4.8 All sunken vessels, barges, pontoons that may have sunk during the project shall be salvaged and removed.

5 Inspection and Remedial Works

- 5.1 The marine structure shall be inspected by a competent person before any person carries out work in it at the start of any shift or, of continuous working is undertaken, at least once in every period of 12 hours. The results of such inspection shall be recorded in writing and the entry countersigned by the Project Manager or his nominated representative on a daily basis.
- 5.2 The marine structure shall also be inspected by a competent person after any incident which may have affected its strength or structural integrity.
- 5.3 If any remedial works are found to be necessary all workers not involved in such work shall be removed to a safe place on land before such work is commenced.
- 5.4 Any remedial works shall be designed by a PE and approved by the Engineer.

6 Diving

- 6.1 All diving works shall comply with “SS 511, Diving at Work”. Prior to the commencement of any dive, the Contractor shall submit a dive plan in accordance to SS 511 for the Engineer’s approval.

7 Emergency Procedures

- 7.1 The Contractor shall draw up emergency plans to cover all foreseeable contingencies and these shall be approved by the Engineer before any marine work takes place. They shall include provision for the setting up of an emergency control centre and management team to co-ordinate the rescue procedure or other response.
- 7.2 The Contractor shall ensure that all persons including those who are not employees of the Contractor or of his sub-contractors who work on or over water for whatever reason are briefed in these procedures, in appropriate languages which they understand, before commencing work.
- 7.3 A desk top exercises shall be held for the worst case emergency scenario involving the marine structures within three (3) months of the permanent works commencing thereon.

CONTAMINATED GROUND

1 General

- 1.1 Soil samples at appropriate depths and spacing shall be taken for testing by a competent person to identify any contaminant present as well as monitoring of airborne contaminants through air sampling. Soil contaminants to consider shall include, but not limited to, heavy metals and their derivatives, hydrocarbon compounds and asbestos. Airborne contaminants to consider shall include, but not limited, methane (CH₄) and other flammable gases.
- 1.2 The Contractor must take all necessary precautions to prevent any person from being exposed to the risk posed by the contaminants.
- 1.3 It shall be noted that contamination can be caused by a range of different hazardous materials and by a mixture of concentrations and distributions. Contaminants can also migrate to adjacent areas via ground water.
- (a) Measures shall be taken in the design to alleviate the risks and describe those hazards that are not reasonably practicable to remove by design but must be controlled by the Contractor and any other relevant party.
 - (b) The Contractor shall ensure that sufficient information is provided on the nature, extent and level of contamination and that all personnel entering the site shall be informed of the hazards and the precautions needed; and
 - (c) All permissible exposure limits shall be established and communicated.

2 Site Layout

- 2.1 The perimeter of the site shall be hoarded and suitable warning signs posted. Access into and out of the site shall be controlled via one entrance with washing and changing facilities for personnel and a wash-bay for vehicles leaving the site.
- 2.2 The main site office shall be located in a “clean” area as recommended by the Environmental, Safety and Health Specialist, and may include a canteen for personnel to take their meals.
- 2.3 Security shall be provided to prevent unauthorised access onto the site.
- 2.4 Established thoroughfares and alternative routes across the site shall be clearly defined and maintained.

3 Hygiene

- 3.1 A high standard of personal hygiene shall be practised and enforced at all times.
- 3.2 The consumption of food and drinks shall be confined to the canteen area. No smoking is allowed on site.
- 3.3 The washing and changing facilities shall include storage for contaminated clothing, footwear etc. and arrangements shall be made for the washing and drying of these.
- 3.4 Appropriate Personal Protective Equipment (PPE), which may include but not limited to waterproof safety boots and gloves when handling wet material, shall be provided for all personnel working on site.
- 3.5 A boot wash shall be situated immediately outside the entrance to the washing and changing facilities, and this shall include running water and either fixed or hand brushes to remove contaminated soils.

4 Health and Safety

- 4.1 An Industrial Hygiene Specialist shall be engaged by the Contractor to carry out the risk assessment for the affected area. He / she may not necessary be on site at all times, however he / she is to be available on site whenever the need for professional advice arises. The appointment of such a specialist shall be subjected to the acceptance of the Engineer.
- 4.2 A Designated Workplace Doctor shall be engaged to attend to the health of the workers exposed to contaminated materials while working on site. He / She need not be stationed on site but prior arrangements must be made to enable him / her to attend to the workers when the need arises. Periodic medical examination and monitoring of workers are to be carried out at the advice of the Designated Workplace Doctor.
- 4.3 Adequate first aid provisions shall be made available on site with a first aid station located next to the washing facilities.
- 4.4 Practical measures shall be implemented to control dust generation on site that may pose a possible hazard to those working on-site as well as the public.
- 4.5 Air quality on site shall be monitored on a frequency deemed appropriate by the site engineer or as advised by the Industrial Hygiene Specialist. Gases to be monitored include, but not limited to, methane (CH₄) and other flammable and toxic gases, with emergency plans prepared in the event permissible limits are breached. A record of the daily monitoring is to be submitted to the Engineer weekly.

- 4.6 Work in excavations deeper than one (1) metre as well as confined spaces are to be controlled via a Permit-To-Work system. And all work in confined spaces are to comply with SS568, Code of Practice for Confined Spaces.
- 4.7 Excavation greater than two (2) metre in depth shall be designated a restricted area and worker shall not work alone and shall have a watcher at the surface. This is in addition to the need for a Permit-To-Work.
- 4.8 Facemasks shall be worn by personnel working over borehole while it is being advanced through the waste and before the temporary casing is installed down to natural ground.

5 Operational Regime

- 5.1 On-site speed limits shall be applied as a mandatory standard and due diligence shall be given to any operations which are likely to create a dust nuisance.
- 5.2 Arrangements shall be made for dewatering of excavations. Site leachate shall be regarded as hazardous.
- 5.3 Discharge of extracted leachate shall be to an area approved for such disposal by the National Environment Agency.
- 5.4 Excavation and compaction work shall be carried out by use of track driven hydraulic excavators. Waste dumping and compaction shall be carried out by tracked or steel-wheeled plant.
- 5.5 All machinery/plant/vehicle used on site shall have enclosed air-conditioned cabs.
- 5.6 All site plant and machinery shall be thoroughly washed down before leaving the site.

6 Disposal of Dumping Ground Material

- 6.1 The Contractor shall comply with all the statutory requirements as laid down by the National Environment Agency with regards to the disposal of contaminated waste material.
- 6.2 The Contractor shall transport waste material directly from the excavation to the approved dumping ground and shall discharge the waste directly into position. No stockpiles of waste are allowed on site.

D&B RAIL PROJECTS CIVIL DESIGN SAFETY SUBMISSIONS

1 Introduction

- 1.1 The Contractor shall be required to prepare and submit risk assessment reports for the following project life cycle:
- a) Design stages: Pre-Final Design and Final Design;
 - b) Pre-construction; and
 - c) Project handover
- 1.2 The risk assessment reports to be submitted at the Pre-Final Design Stage shall be the Civil Design Pre-Final Safety Submissions and at the Final Design Stage shall be the Civil Design Safety Submission (Civil DSS).
- 1.3 The Civil Design Pre-Final Safety Submissions shall be submitted one (1) month after pre-final design submission and the Civil Design Safety Submissions (Civil DSS) shall be submitted one (1) month after the final design submission.
- 1.4 After the completion of the Civil DSS, the Contractor shall use it as a base for the preparation of the Civil Construction Safety Submissions (Civil CNSS). The CNSS can be submitted in accordance to structural packages and shall be submitted to the Engineer two (2) months before application for permit to excavate.
- 1.5 The Contractor shall also prepare and submit a Civil Handover Safety Submission (Civil HSS). The Civil HSS shall be submitted four (4) months before the completion of system test running or handing over of project to the Operator for trial run, whichever is earlier.
- 1.6 The Accident Frequency, Accident Severity and Risk Index for the risk assessment and Hazard Register Structure for the Civil DSS, CNSS and the HSS shall be in compliance with Clause 4 of this Annex.
- 1.7 The Civil DSS, CNSS and HSS shall be subjected to the acceptance of the Engineer. The Contractor shall make amendments and revise the Safety Submissions in accordance with the Engineer's comments. The Contractor shall also attend site inspections as per required by the Engineer.

2 Safety Submissions

2.1 Civil Design Safety Submissions (CIVIL DSS)

2.1.1 The objectives of the Safety Submissions at the Pre-Final and Final design stages are to demonstrate that the design concept of the permanent works and the proposed construction methodologies and measures under the specific contract has addressed the relevant identified preliminary hazards and newly identified construction, operation, maintenance and public safety hazards.

2.1.2 The fundamental information to be provided in the Civil Design Safety Submissions shall include but not limited to the following:

(i) Background Information

- (a) An executive summary highlighting the major areas of concern and the required mitigation measures including the status of findings
- (b) Brief description of the Civil Contract and its scope (the number of stations, tunnel / viaduct / at grade trackway, stations descriptions, alignment and etc.)
- (c) Environment (On adjacent buildings, utilities, water bodies)
- (d) Proposed Method of Construction
- (e) Details of key milestone schedules of the Contract

(ii) Identification of Major Hazards and Mitigation

- (a) Relevant hazards identified in the Civil Concept Safety Submissions (furnished by the Authority)
- (b) Impact To Utilities
- (c) Impact To Buildings and Adjacent Structures
- (d) Impact To Existing and Future Rapid Transit System
- (e) Flooding (to public and own works)
- (f) Surface / Ground Settlement
- (g) Environmental Impact
- (h) Demolition of Buildings and Structures
- (i) Underpinning of Buildings and Structures

- (j) Construction near high risks areas, e.g. petrol stations, ammunition stores, power plants, dump sites and etc.
 - (k) Risk associated with future provisions
 - (l) Risk associated with known future provisions
 - (m) Highlight hazards that cannot be eliminated through design of permanent structures and requires mitigation measures during construction
 - (n) Highlight operation, maintenance and public safety hazards and their proposed mitigation measures (A separate Civil DSS focusing on the operation, maintenance and public safety hazards shall be prepared as highlighted in Clause 2.1.3)
 - (o) Major risk to workers and public
 - (p) Specific compliance requirements during construction for safety and health
- (iii) Hazard and Risk Management Process
- (a) A description on the roles and responsibilities in the review and acceptance of the mitigation measures
 - (b) The hazard and risk mitigation process shall demonstrate that the high- level hazards have been assessed and that there is no hazard with residual “Intolerable” risk categorisation after the proposed mitigation measures.

2.1.3 The Civil DSS for operation, maintenance and public safety hazards shall highlight design provisions for safe operation and maintenance of civil infrastructure, architecture fittings / finishes and E&M equipment and fittings, as well as address the major operation, maintenance and public safety risks . It shall include, but not limited to, the following:

- (i) Falling from height;
- (ii) Overloading of slab (including equipment delivery and replacement routes);
- (iii) Lifting (focusing on permanent lifting hooks, beams, lifting machines/equipment or cranes provided for maintenance purposes);
- (iv) Working in confined space;
- (v) Fire / explosion (storage / handling of hazardous substances / materials);

- (vi) Ergonomics (posture of workers during maintenance);
- (vii) Health (noise, heat and etc);
- (viii) Public use of infrastructure (prevention of slip, trip, falls, obstruction and etc.); and
- (ix) Others.

2.1.4 The Civil DSS for operation, maintenance and public safety hazards shall be subsequently transferred to Civil Handover Safety Submission (Civil HSS) to be handover to the operator.

2.2 Civil Construction Safety Submission (CIVIL CNSS)

2.2.1 The objective of the Civil CNSS is to demonstrate that the residual hazards transferred from the Civil DSS have been mitigated during construction phase in the specific contract and that the Contractor has in place the necessary arrangement for managing safety risks.

2.2.2 The fundamental information to be provided in the Civil CNSS is the construction health and safety plan that shall include but not limited to the following areas:

- (i) An executive summary report highlighting the major areas of concerns and the status of findings.
- (ii) Description of contract work and scope:
 - Major work description and scope;
 - Programme details; and
 - Brief details of subcontractors and other consultants.
- (iii) Communication and management of the work:
 - Contractor's Safety Management System prepared according to the guideline of CP 79. The element on emergency preparedness shall include a flood protection plan, a fire safety plan etc;
 - Arrangement for monitoring and review of health and safety performance; and
 - Arrangement for the exchange of design information between the developer, designer and contractors.
- (iv) Hazard management covering:

- Proposed mitigation measures of the residual risk transferred from the Civil DSS;
- Temporary works design such as temporary support structure, false work system, design of decking for support of road traffic etc;
- Further major hazards identified by the Contractor (besides residual hazards transferred from Civil DSS) and proposed mitigation measures for these identified “new” hazards. The information shall highlight the major construction hazards that are specific to the contract locality; and
- Other envisaged significant health & safety risk during the construction process and its mitigation measures.

(iv) Environmental control plan (in compliance with ISO 14000).

2.2.3 The Civil CNSS shall not focus on common construction work activities such as heavy lifting, hot works, form work erection and etc. These routine construction work activities shall be addressed through method statements.

2.3 Civil Handover Safety Submission (Civil HSS)

2.3.1 The objective of the Civil HSS is to provide the operator/maintenance agencies the necessary information on operation, maintenance and public safety hazards and those residual hazards or information that are relevant to the health and safety of any future construction work, which includes cleaning, maintenance, alterations, refurbishment and demolition.

2.3.2 The fundamental information to be provided in the HSS is the Health and Safety File that shall include but not limited to the following areas:

- (i) An executive summary report highlighting the major areas of concerns and status of findings.
- (ii) Summary list of information and final as-built drawings of the structure, including safe working loads for floors and roofs.
- (iii) Key structural principles incorporated in the design of the structure.
- (iv) Schedule of hazardous substances and location of where they are used, if any.
- (v) Information on:
 - Operation, maintenance and public safety hazards, including hazardous areas;

- Specialist manuals for operating and maintenance and replacement purposes; and
 - Fragile materials that maintainer must exercise additional precautions.
- (vi) Hazards that should be considered during future construction work on or nearby the premises.

3 Risk Management Facilitator (RMF) / Designed For Safety Professional (DfS Professional) for the Hazard Identification and Risk Management Process

3.1 Contractor shall propose and engage a qualified and competent RMF / DfS Professional. The qualifications of RMF / DfS Professional proposed for this contract shall include:

- a) Reasonable exposure in safety and health for construction especially on transportation infrastructure projects in a similar nature to this Contract, and
- b) Attended the DfS for Professional Course and passed the assessment, or equivalent, and either
 - Be a registered PE or Architect with a Practicing Certificate or
 - Have 10 years relevant experience in the design (at least five (5) years in design which includes contributions to designs, writing specifications) and the supervision of the construction of structures; and
 - Have a degree accepted by Professional Engineers Board (PEB) or Board Of Architects and construction related degree accepted by Singapore Institute of Surveyors and Valuers (SISV) and Society of Project Managers (SPM).

The final approval for the appointed RMF / DfS Professional shall be within the Authority's discretion. The appointed DFS Professional is to perform the necessary duties as part of the delegation of the Authority's duty.

3.2 The RMF / DfS Professional shall facilitate the hazard identification and risk management sessions for the preparations of the Safety Submissions. The Authority shall be invited to attend these sessions as observers. The Authority may send representative(s) to attend if deemed necessary.

3.3 The RMF / DfS Professional shall be the appointed person in-charge of the preparation and submission of the Safety Submissions. The hazard registers are live documents. He shall add new hazards identified, monitor and update the hazards in the register to ensure all hazards are mitigated and closed.

3.4 The RMF / DfS Professional shall attend the Engineer's Project Safety Committee Meetings and any other risk management meetings directed by the Engineer.

4 Risk Matrix, Hazard Register Structure and Hazard Action Form (HAF)

4.1 The Contractor shall prepare the Safety Submissions using the risk matrix given:

Table 1 : Likelihood of Occurrence

No	Likelihood	Rating	Description
1	Almost Certain	5	Likely to occur within the next month. Probability: >90% chance of occurring
2	Likely	4	Likely to occur between 1 to 2 months Probability: 60% to 90% chance of occurring
3	Possible	3	Likely to occur between 3 months to 1 year Probability: 30% to 60% chance of occurring
4	Unlikely	2	Likely to occur between 1 year to 3 years Probability: 10% to 30% chance of occurring
5	Very Unlikely	1	Likely to occur beyond 3 years Probability: <10% chance of occurring

Table 2 : Magnitude of Impact

No	Consequence	Rating	Description(*)
1	Extreme (Catastrophic)	5	<p>Workplace Safety</p> <ul style="list-style-type: none"> • Fatality or multiple fatalities and/or events which triggers Commission of Inquiry under the WSH Act; and/or • Loss of whole production for greater than 3 days and/or • Total loss in excess of \$1 million.

No	Consequence	Rating	Description(*)
2	Major	4	Workplace Safety <ul style="list-style-type: none"> Total permanent incapacity or Dangerous Occurrences classified under the WSH Act; and/or Damaged to works or plants causing delays of up to 3 days; and/or Total loss in excess of \$250,000 but up to \$1 million.
3	Moderate	3	Workplace Safety <ul style="list-style-type: none"> MOM reportable accident (More than 3 days MC) or Occupational Diseases; and/or Damage to works or plants causing delays of up to 1 day; and/or, Total loss in excess of \$25,000 but up to \$250,000.
4	Minor	2	Workplace Safety <ul style="list-style-type: none"> Minor injuries, MOM reportable accident (3 days or lesser MC or light duties); and/or Damage to works or plants does not cause significant delays; and/or Total loss of up to \$25,000.
5	Insignificant	1	Workplace Safety <ul style="list-style-type: none"> First aid cases (e.g. minor scratches) Damage to works or plants that causes insignificant delays; and/or Total loss of up to \$1,000.

Note:

(*) If more than one of the descriptions occurs, the severity rating would be increased to the next higher level. Applicable to item numbers 2 and 3 only.

Table 3: Risk Index Matrix

Risk Category			Magnitude of Impact (Severity)				
			1	2	3	4	5
			Insignificant	Minor	Moderate	Major	Extreme
Likelihood of Occurrence (Frequency)	5	Almost Certain	B	B	A	A	A
	4	Likely	C	B	B	A	A
	3	Possible	D	C	B	B	A
	2	Unlikely	D	D	C	C	B
	1	Very Unlikely	D	D	C	C	C

The definitions of the risk indices determined from the Risk Index Assessment Matrix are presented in the table 4.

Table 4: Definition of Risk Index

Risk Index	Description	Definition
A (Very High)	Intolerable	Risk shall be reduced by whatever means possible.
B (High)	Undesirable	Risk shall only be accepted if further risk reduction is not practicable.
C (Medium)	Tolerable	Risk shall be accepted subject to demonstration that the level of risk is as low as reasonably practicable.
D (Low)	Acceptable	Risk is acceptable.

- 4.2 For hazards relating to **operation and maintenance**, the Accident Frequency, Accident Severity and the Risk Category shall be in accordance to the definitions given in Table 5, 6, 7 and 8.

Table 5: Accident Frequency

Category		* Definition	Frequency Guide (Operating hour) <i>acc = accident</i>
1	Frequent	Likely to occur frequently. The hazard will be continually experienced.	≥ 1 acc per 100 hrs
2	Probable	Will occur several times. The hazard can be expected to occur often.	1×10^2 hrs < 1 acc $\leq 1 \times 10^4$ hrs
3	Occasional	Likely to occur several times. The hazard can be expected to occur several times.	1×10^4 hrs < 1 acc $\leq 1 \times 10^5$ hrs
4	Remote	Likely to occur some time in the system's life cycle. The hazard can reasonably be expected to occur.	1×10^5 hrs < 1 acc $\leq 1 \times 10^6$ hrs
5	Improbable	Unlikely to occur but possible. It can be assumed that the hazard may exceptionally occur.	1×10^6 hrs < 1 acc $\leq 1 \times 10^8$ hrs
6	Incredible	Extremely unlikely to occur. It can be assumed that the hazard may not occur.	1×10^8 hrs < 1 acc $\leq 1 \times 10^{10}$ hrs

* Source: European Standard EN 50126

Table 6: Accident Severity

Category		* Definition
I	Catastrophic	Fatalities and / or multiple severe injuries and / or major damage to the environment.
II	Critical	Single fatality and / or severe injury and / or significant damage to the environment.
III	Marginal	Minor injury and / or significant threat to the environment.
IV	Insignificant	Possible minor injury.

Table 7: Risk Category

Risk Category*		Accident Severity Category			
		I	II	III	IV
		Catastrophic	Critical	Marginal	Insignificant
Accident Frequency Category	Frequent	Intolerable	Intolerable	Intolerable	Undesirable
	Probable	Intolerable	Intolerable	Undesirable	Tolerable
	Occasional	Intolerable	Undesirable	Undesirable	Tolerable
	Remote	Undesirable	Undesirable	Tolerable	Negligible
	Improbable	Tolerable	Tolerable	Negligible	Negligible
	Incredible	Negligible	Negligible	Negligible	Negligible

Table 8: Definition of Risk Categories

Risk Category	Definition
Intolerable	Risk that shall be reduced by whatever means possible.
Undesirable	Risk that shall only be accepted if further risk reduction is not practicable.

PS-A-219

Tolerable	Risk that shall be accepted subject to it being reduced so far as is reasonably practicable.
Negligible	Risk that shall be accepted subject to endorsement of the safety submission.

HAZARD REGISTER STRUCTURE

1			2	3	4	5	6	7			8	9			10	11	12	13	14	15	16	17
Risk ID			Previous Hazard ID	Work Activity	Hazard	Hazard Cause	Impact	Initial Risk Category Ri			Mitigation Measures	Residual Risk Category Rr			Future Actions	Risk Owner	Action Owner	Due Date By	Risk Exposure Period	Target Risk Rating	Status	Remark
Hazard No.	Hazard Code	Running Number						F	S	Ri		F	S	Rr								

Definitions of Terms in the Hazard Log

Column	Field Name	Description
1.	Risk ID	Numbering system and hazard code to refer to details and the list of hazard codes attached in next page.
2.	Previous ID	The hazard number that was previously assigned to the particular hazard before it was transferred to the current hazard register.
3.	Work Activity	Describes the construction activity that may have risks.
4.	Hazard	A situation or circumstance in which there is a potential for an accident to occur that may cause injury or fatality to personnel, or damage to system or environment. For example, toxic fumes are a potential hazard. In many cases, the hazard may be continuously present under normal conditions, referred to as an intrinsic hazard. Note that the hazard is distinct from the accident, but is rather the circumstances in which the accident may occur.
5.	Hazard Cause	The events, circumstances or conditions that result in the creation of the hazard.
6.	Impact	The result of such hazard i.e. type of accident or incident that may happen if this hazard occurs.
7.	Initial Risk Category (Ri)	The initial risk assessed prior to mitigation measures is implemented. This is dependent on the frequency (F) rating and severity (S) rating.
8.	Mitigation Measures	Provision of safeguards/control measures for considerations. The risks should be re-assessed to see if either probability or severity rate has been reduced by the proposed mitigation measures.
9.	Residual Risk Category (Rr)	The risk assessed when the proposed mitigation measures are in place. This is dependent on the frequency (F) rating and severity (S) rating.
10.	Future Actions	These are additional mitigation measures identified but yet to be implemented.
11.	Risk Owner	The person who carries the responsibility for ensuring that the risk is monitored and, where appropriate, effectively managed. They might not be the person who has to do the necessary actions, but they must continuously aware of the risk and closing-out status.
12.	Action Owner	This is assigned to the person who is best able to control the risk mitigation on site.
13.	Due Date By	Timescale when mitigation measures are to be implemented.
14.	Risk Exposure Period	The period the risk will be active for work activity described.
15.	Target Risk Rating	Mitigation rating to be achieved.
16.	Status	Description of current status for the risk, which also include the implementation status for proposed mitigation measures. The status shall be reviewed monthly. Closed-out date shall be recorded against the status.
17.	Remark	Any further comments pertaining to the risks.

**Where the hazards are deleted, the reason for deletion shall be stated clearly in the Hazard Register.

Numbering System:

Contract Number / Site Contract Number / Stage / Hazard Code / Hazard Running Number / Packages

Definition:

- i. **Contract Number:** The Contract number of the A/E or Contractor who prepares the Safety Submission.
- ii. **Site Contract Number:** The contract number of site the safety submission if for.
- iii. **Hazard Code:** The hazard classification codes for the different category of hazards.
- iv. **Hazard Running Number:** The hazard running number based on the category of hazards starting with “001”.
- v. **Packages:** This refers to the number of Construction Safety Submissions (CNSS) proposed by the Contractors, usually using alphabets: A, B, C, D and etc. Only applicable to construction stage.

Hazard Classification Reference Codes

Ref	Category
100	Earth Retaining Supporting Structures (ERSS)
101	Temporary Structures
102	Diaphragm Walling/Piling
103	Permanent Structures
104	Ground Conditions
105	Adjacent Structures or buildings
106	Existing Utilities
107	Existing RTS Stations, Tunnels and Viaducts
108	Existing Road Tunnels and Viaducts
109	Obstructions
110	Interface with adjacent contracts
111	Interface with adjacent developments
112	Future developments or Addition & Alteration works
113	Tunnelling
114	Underpinning Works
115	Demolition Works

116	Blasting Works
117	Construction Methodology
118	Ground Improvements
119	Instrumentation
120	Hazardous Materials
121	Fire & Explosions
122	Flooding
123	Confined Space
124	Architectural/Glazing Works
125	Maintenance
999	Others

Land Transport Authority 	HAZARD ACTION FORM
--	---------------------------

Actionee / Hazard Owner :		Hazard Action Form No:		Hazard No:		Part 1
Additional Actionee / Hazard Owner :		Date Issued		Response Date Due		
Hazard						
Hazard Cause						
Accident Potential						
Initial Accident Risk	Severity:	Accident Frequency:		Risk Class:		

Description Of Action Needed :			Part 2 – Hazard Owner(s)
Actionee(s) Response :			
Name :	Signature :	Date :	

<u>Action Review & Status</u>				Part 3
Decision/Comments On Part 2 :				
Residual Accident Risk	Severity:	Accident Frequency:	Risk Class:	
Name :	Signature :	Date :		
Subsequent Action Raised : <input type="checkbox"/> Yes ⇒ Action No. : <input type="checkbox"/> No				

BUILD ONLY RAIL PROJECTS CIVIL DESIGN SAFETY SUBMISSIONS

1 Introduction

- 1.1 The Contractor shall be required to prepare and submit risk assessment reports for the following stages of the project life cycle:
- (i) Pre-construction Stage
 - (ii) Project Handover
- 1.2 The Contractor shall be given a copy of a Civil Design Safety Submission prepared by the Authority or its Consultant. The Contractor shall use it as a base for the preparation of the Civil Construction Safety Submissions (Civil CNSS). The CNSS can be submitted in accordance to structural packages and shall be submitted to the Engineer two (2) months before application for permit to excavate or two (2) months before making structural submission to the Building and Construction Authority (BCA) for temporary works. The final timing for the submission of the CNSS shall be decided by the Engineer.
- 1.3 The Contractor shall also prepare and submit a Civil Handover Safety Submission (Civil HSS). The Civil HSS shall be submitted four (4) months before the completion of system test running or handing over of project to the Operator for trial run, whichever is earlier.
- 1.4 The Accident Frequency, Accident Severity and Risk Index for the risk assessment and Hazard Register Structure for the Civil DSS, CNSS and the HSS shall be in compliance with Clause 4 of this Annex.
- 1.5 The Civil CNSS and HSS shall be subjected to the acceptance of the Engineer. The Contractor shall make amendments and revise the Safety Submissions in accordance with the Engineer's instructions.

2 Safety Submissions

2.1 Civil Construction Safety Submission (CIVIL CNSS)

- 2.1.1 The objective of the Civil CNSS is to demonstrate that the residual hazards transferred from the Civil DSS have been mitigated during construction phase in the specific contract and that the Contractor has in place the necessary arrangement for managing safety risks.
- 2.1.2 The fundamental information to be provided in the Civil CNSS is the construction health and safety plan that shall include but not limited to the following areas:
- (i) An executive summary report highlighting the major areas of concerns and the status of findings.

- (ii) Description of contract work and scope:
 - Major work description and scope;
 - Programme details; and
 - Brief details of subcontractors and other consultants.
- (iii) Communication and management of the work:
 - Contractor's Safety Management System prepared according to the guideline of CP 79. The element on emergency preparedness shall include a flood protection plan, a fire safety plan, etc;
 - Arrangement for monitoring and review of health and safety performance; and
 - Arrangement for the exchange of design information between the developer, designer and contractors.
- (iv) Hazard management covering:
 - Proposed mitigation measures of the residual risk transferred from the Civil DSS;
 - Temporary works design such as temporary support structure, false work system, design of decking for support of road traffic, etc;
 - Further major hazards identified by the Contractor (besides residual hazards transferred from Civil DSS) and proposed mitigation measures for these identified "new" hazards. The information shall highlight the major construction hazards that are specific to the contract locality; and
 - Other envisaged significant health & safety risk during the construction process and its mitigation measures.
- (v) Environmental control plan (in compliance with ISO 14000).

2.1.3

The Civil CNSS shall not focus on common construction work activities such as heavy lifting, hot works, form work erection and etc. These routine construction work activities shall be addressed through method statements.

- 2.2 Civil Handover Safety Submission (Civil HSS)
- 2.2.1 The objective of the Civil HSS is to provide the operator/maintenance agencies the necessary information on maintenance hazards and those residual hazards or information that are relevant to the health and safety of any future construction work, which includes cleaning, maintenance, alterations, refurbishment and demolition.
- 2.2.2 The fundamental information to be provided in the HSS is the Health and Safety File that shall include but not limited to the following areas:
- (i) An executive summary report highlighting the major areas of concerns and status of findings.
 - (ii) Summary list of information and final as-built drawings of the structure, including safe working loads for floors and roofs.
 - (iii) Key structural principles incorporated in the design of the structure.
 - (iv) Schedule of hazardous substances and location of where they are used, if any.
 - (v) Information on:
 - Maintenance hazards, including hazardous areas;
 - Specialist manuals for operating and maintenance and replacement purposes; and
 - Fragile materials that maintainer must exercise additional precautions.
 - (vi) Hazards that should be considered during future construction work on or nearby the premises.
3. **Risk Management Facilitator (RMF) / Designed For Safety Professional (DfS Professional) for the Hazard Identification and Risk Management Process**
- 3.1 Contractor shall propose and engage a qualified and competent RMF / DfS Professional. The qualifications of RMF / DfS Professional proposed for this contract shall include:
- (i) Reasonable exposure in safety and health for construction especially on transportation infrastructure projects in a similar nature to this Contract, and
 - (ii) Attended the DfS for Professional Course and passed the assessment, or equivalent, and either

- Be a registered PE or Architect with a Practicing Certificate or
- Have 10 years relevant experience in the design (at least 5 years in design which includes contributions to designs, writing specifications) and the supervision of the construction of structures; and
- Have a degree accepted by Professional Engineers Board (PEB) or Board Of Architects and construction related degree accepted by Singapore Institute of Surveyors and Valuers (SISV) and Society of Project Managers (SPM).

The final approval for the appointed RMF / DfS Professional shall be within the Authority's discretion. The appointed DFS Professional is to perform the necessary duties as part of the delegation of the Authority's duty.

- 3.2 The RMF / DfS Professional shall facilitate the hazard identification and risk management sessions for the preparations of the Safety Submissions. The Authority shall be invited to attend these sessions as observers. The Authority may send representative(s) to attend if deemed necessary.
- 3.3 The RMF / DfS Professional shall be the appointed person in-charge of the preparation and submission of the Safety Submissions. The hazard registers are live documents. He shall add new hazards identified, monitor and update the hazards in the register to ensure all hazards are mitigated and closed.
- 3.4 The RMF / DfS Professional shall attend the Engineer's Project Safety Committee Meetings and any other risk management meetings directed by the Engineer.

4 Risk Matrix, Hazard Register Structure and Hazard Action Form(HAF)

- 4.1 The Contractor shall prepare the Safety Submissions using the risk matrix given:

Table 1 : Likelihood of Occurrence

No	Likelihood	Rating	Description
1	Almost Certain	5	Likely to occur within the next month. Probability: >90% chance of occurring
2	Likely	4	Likely to occur between 1 to 2 months Probability: 60% to 90% chance of occurring
3	Possible	3	Likely to occur between 3 months to 1 year Probability: 30% to 60% chance of occurring
4	Unlikely	2	Likely to occur between 1 year to 3 years Probability: 10% to 30% chance of occurring
5	Very Unlikely	1	Likely to occur beyond 3 years Probability: <10% chance of occurring

Table 2 : Magnitude of Impact

No	Consequence	Rating	Description(*)
1	Extreme (Catastrophic)	5	Workplace Safety <ul style="list-style-type: none"> • Fatality or multiple fatalities and/or events which triggers Commission of Inquiry under the WSH Act; and/or • Loss of whole production for greater than 3 days and/or • Total loss in excess of \$1 million.
2	Major	4	Workplace Safety <ul style="list-style-type: none"> • Total permanent incapacity or Dangerous Occurrences classified under the WSH Act; and/or • Damaged to works or plants causing delays of up to 3 days; and/or • Total loss in excess of \$250,000 but up to \$1 million.
3	Moderate	3	Workplace Safety <ul style="list-style-type: none"> • MOM reportable accident (More than 3 days MC) or Occupational Diseases; and/or • Damage to works or plants causing delays of up to 1 day; and/or, • Total loss in excess of \$25,000 but up to \$250,000.
4	Minor	2	Workplace Safety <ul style="list-style-type: none"> • Minor injuries, MOM reportable accident (3 days or lesser MC or light duties); and/or • Damage to works or plants does not cause significant delays; and/or • Total loss of up to \$25,000.
5	Insignificant	1	Workplace Safety <ul style="list-style-type: none"> • First aid cases (e.g. minor scratches) • Damage to works or plants that causes insignificant delays; and/or • Total loss of up to \$1,000.

Note:

(*) If more than one of the descriptions occurs, the severity rating would be increased to the next higher level. Applicable to item numbers 2 and 3 only.

Table 3: Risk Index Matrix

Risk Category			Magnitude of Impact (Severity)				
			1	2	3	4	5
			Insignificant	Minor	Moderate	Major	Extreme
Likelihood of Occurrence (Frequency)	5	Almost Certain	B	B	A	A	A
	4	Likely	C	B	B	A	A
	3	Possible	D	C	B	B	A
	2	Unlikely	D	D	C	C	B
	1	Very Unlikely	D	D	C	C	C

The definitions of the risk indices determined from the Risk Index Assessment Matrix are presented in the table 4.

TABLE 4: Definition of Risk Index

Risk Index	Description	Definition
A (Very High)	Intolerable	Risk shall be reduced by whatever means possible.
B (High)	Undesirable	Risk shall only be accepted if further risk reduction is not practicable.
C (Medium)	Tolerable	Risk shall be accepted subject to demonstration that the level of risk is as low as reasonably practicable.
D (Low)	Acceptable	Risk is acceptable.

- 4.2 For hazards relating to **operation and maintenance**, the Accident Frequency, Accident Severity and the Risk Category shall be in accordance to the definitions given in Table 5, 6, 7 and 8.

Table 5: Accident Frequency

Category		* Definition	Frequency Guide (Operating hour) <i>acc = accident</i>
1	Frequent	Likely to occur frequently. The hazard will be continually experienced.	≥ 1 acc per 100 hrs
2	Probable	Will occur several times. The hazard can be expected to occur often.	1×10^2 hrs < 1 acc $\leq 1 \times 10^4$ hrs
3	Occasional	Likely to occur several times. The hazard can be expected to occur several times.	1×10^4 hrs < 1 acc $\leq 1 \times 10^5$ hrs
4	Remote	Likely to occur some time in the system's life cycle. The hazard can reasonably be expected to occur.	1×10^5 hrs < 1 acc $\leq 1 \times 10^6$ hrs
5	Improbable	Unlikely to occur but possible. It can be assumed that the hazard may exceptionally occur.	1×10^6 hrs < 1 acc $\leq 1 \times 10^8$ hrs
6	Incredible	Extremely unlikely to occur. It can be assumed that the hazard may not occur.	1×10^8 hrs < 1 acc $\leq 1 \times 10^{10}$ hrs

* Source: European Standard EN 50126

Table 6: Accident Severity

Category		* Definition
I	Catastrophic	Fatalities and / or multiple severe injuries and / or major damage to the environment.
II	Critical	Single fatality and / or severe injury and / or significant damage to the environment.
III	Marginal	Minor injury and / or significant threat to the environment.
IV	Insignificant	Possible minor injury.

Table 7: Risk Category

Risk Category*		Accident Severity Category			
		I	II	III	IV
		Catastrophic	Critical	Marginal	Insignificant
Accident Frequency Category	Frequent	Intolerable	Intolerable	Intolerable	Undesirable
	Probable	Intolerable	Intolerable	Undesirable	Tolerable
	Occasional	Intolerable	Undesirable	Undesirable	Tolerable
	Remote	Undesirable	Undesirable	Tolerable	Negligible
	Improbable	Tolerable	Tolerable	Negligible	Negligible
	Incredible	Negligible	Negligible	Negligible	Negligible

Table 8: Definition of Risk Categories

Risk Category	Definition
Intolerable	Risk that shall be reduced by whatever means possible.
Undesirable	Risk that shall only be accepted if further risk reduction is not practicable.
Tolerable	Risk that shall be accepted subject to it being reduced so far as is reasonably practicable.
Negligible	Risk that shall be accepted subject to endorsement of the safety submission.

HAZARD REGISTER STRUCTURE

1			2	3	4	5	6	7			8	9			10	11	12	13	14	15	16	17
Risk ID			Previous Hazard ID	Work Activity	Hazard	Hazard Cause	Impact	Initial Risk Category Ri			Mitigation Measures	Residual Risk Category Rr			Future Actions	Risk Owner	Action Owner	Due Date By	Risk Exposure Period	Target Risk Rating	Status	Remark
Hazard No.	Hazard Code	Running Number						F	S	Ri		F	S	Rr								

Definitions of Terms in the Hazard Log

Column	Field Name	Description
1.	Risk ID	Numbering system and hazard code to refer to details and the list of hazard codes attached in next page.
2.	Previous ID	The hazard number that was previously assigned to the particular hazard before it was transferred to the current hazard register.
3.	Work Activity	Describes the construction activity that may have risks.
4.	Hazard	A situation or circumstance in which there is a potential for an accident to occur that may cause injury or fatality to personnel, or damage to system or environment. For example, toxic fumes are a potential hazard. In many cases, the hazard may be continuously present under normal conditions, referred to as an intrinsic hazard. Note that the hazard is distinct from the accident, but is rather the circumstances in which the accident may occur.
5.	Hazard Cause	The events, circumstances or conditions that result in the creation of the hazard.
6.	Impact	The result of such hazard i.e. type of accident or incident that may happen if this hazard occurs.
7.	Initial Risk Category (Ri)	The initial risk assessed prior to mitigation measures is implemented. This is dependent on the frequency (F) rating and severity (S) rating.
8.	Mitigation Measures	Provision of safeguards/control measures for considerations. The risks should be re-assessed to see if either probability or severity rate has been reduced by the proposed mitigation measures.
9.	Residual Risk Category (Rr)	The risk assessed when the proposed mitigation measures are in place. This is dependent on the frequency (F) rating and severity (S) rating.
10.	Future Actions	These are additional mitigation measures identified but yet to be implemented.
11.	Risk Owner	The person who carries the responsibility for ensuring that the risk is monitored and, where appropriate, effectively managed. They might not be the person who has to do the necessary actions, but they must continuously aware of the risk and closing-out status.
12.	Action Owner	This is assigned to the person who is best able to control the risk mitigation on site.
13.	Due Date By	Timescale when mitigation measures are to be implemented.
14.	Risk Exposure Period	The period the risk will be active for work activity described.
15.	Target Risk Rating	Mitigation rating to be achieved.
16.	Status	Description of current status for the risk, which also include the implementation status for proposed mitigation measures. The status shall be reviewed monthly. Closed-out date shall be recorded against the status.
17.	Remark	Any further comments pertaining to the risks.

**Where the hazards are deleted, the reason for deletion shall be stated clearly in the Hazard Register.

Numbering System:

Contract Number / Site Contract Number / Stage / Hazard Code / Hazard Running Number / Packages

Definition:

- i. **Contract Number:** The Contract number of the A/E or Contractor who prepares the Safety Submission.
- ii. **Site Contract Number:** The contract number of site the safety submission if for.
- iii. **Hazard Code:** The hazard classification codes for the different category of hazards.
- iv. **Hazard Running Number:** The hazard running number based on the category of hazards starting with “001”.
- v. **Packages:** This refers to the number of Construction Safety Submissions (CNSS) proposed by the Contractors, usually using alphabets: A, B, C, D and etc. Only applicable to construction stage.

Hazard Classification Reference Codes

Ref	Category
100	Earth Retaining Supporting Structures (ERSS)
101	Temporary Structures
102	Diaphragm Walling/Piling
103	Permanent Structures
104	Ground Conditions
105	Adjacent Structures or buildings
106	Existing Utilities
107	Existing RTS Stations, Tunnels and Viaducts
108	Existing Road Tunnels and Viaducts
109	Obstructions
110	Interface with adjacent contracts
111	Interface with adjacent developments
112	Future developments or Addition & Alteration works
113	Tunnelling
114	Underpinning Works
115	Demolition Works
116	Blasting Works

PS-A-234

117	Construction Methodology
118	Ground Improvements
119	Instrumentation
120	Hazardous Materials
121	Fire & Explosions
122	Flooding
123	Confined Space
124	Architectural/Glazing Works
125	Maintenance
999	Others

Land Transport  Authority	HAZARD ACTION FORM
--	---------------------------

Actionee / Hazard Owner :		Hazard Action Form No:	Hazard No:	Part 1
Additional Actionee / Hazard Owner :		Date Issued	Response Date Due	
Hazard				
Hazard Cause				
Accident Potential				
Initial Accident Risk	Severity:	Accident Frequency:	Risk Class:	

Description Of Action Needed :			Part 2 – Hazard Owner(s)
Actionee(s) Response :			
Name :	Signature :	Date :	

<u>Action Review & Status</u>				Part 3
Decision/Comments On Part 2 :				
Residual Accident Risk	Severity:	Accident Frequency:	Risk Class:	
Name :	Signature :	Date :		
Subsequent Action Raised: <input type="checkbox"/> Yes ⇒ Action No. : <input type="checkbox"/>				
No				

**D&B ROAD PROJECTS
CIVIL DESIGN SAFETY SUBMISSIONS**

1 Introduction

- 1.1 The Contractor shall be required to prepare and submit risk assessment reports for the following project life cycle:
- (i) Design stages: Pre-Final Design and Final Design
 - (ii) Pre-construction
 - (iii) Project handover
- 1.2 The risk assessment reports to be submitted at the Pre-Final Design Stage shall be the Civil Design Pre-Final Safety Submissions and at the Final Design Stage shall be the Civil Design Safety Submission (Civil DSS).
- 1.3 The Civil Design Pre-Final Safety Submissions shall be submitted one (1) month after pre-final design submission and the Civil Design Safety Submissions (Civil DSS) shall be submitted one (1) month after the final design submission.
- 1.4 After the completion of the Civil DSS, the Contractor shall use it as a base for the preparation of the Civil Construction Safety Submissions (Civil CNSS). The CNSS can be submitted in accordance to structural packages and shall be submitted to the Engineer two (2) months before application for permit to excavate.
- 1.5 The Contractor shall also prepare and submit a Civil Handover Safety Submission (Civil HSS). The Civil HSS shall be submitted four (4) months before the end of the defects liability period (DLP) of the contract.
- 1.6 The Accident Frequency, Accident Severity and Risk Index for the risk assessment and Hazard Register Structure for the Civil DSS, CNSS and the HSS shall be in compliance with Clause 4 of this Annex.
- 1.7 The Civil DSS, CNSS and HSS shall be subjected to the acceptance of the Engineer. The Contractor shall make amendments and revise the Safety Submissions in accordance with the Engineer's instructions.

2 Safety Submissions

2.1 Civil Design Safety Submissions (CIVIL DSS)

2.1.1 The objectives of the Safety Submissions at the Pre-Final and Final design stages is to demonstrate that the design concept of the permanent works and the proposed construction methodologies and measures under the specific contract has addressed the relevant identified preliminary hazards and newly identified construction and maintenance hazards.

2.1.2 The fundamental information to be provided in the Civil Design Safety Submissions shall include but not limited to the following:

(i) Background Information

- (a) An executive summary highlighting the major areas of concern and the required mitigation measures including the status of findings
- (b) Brief description of the Civil Contract and its scope (the number of stations, tunnel/viaduct/at grade trackway, stations descriptions, alignment and etc.)
- (c) Environment (On adjacent buildings, utilities, water bodies)
- (d) Proposed Method of Construction
- (e) Details of key milestone schedules of the Contract

(ii) Identification of Major Hazards and Mitigation

- (a) Relevant hazards identified in the Civil Concept Safety Submissions (furnished by the Authority)
- (b) Impact To Utilities
- (c) Impact To Buildings and Adjacent Structures
- (d) Impact To Existing and Future Rapid Transit System
- (e) Flooding (to public and own works)
- (f) Surface/Ground Settlement
- (g) Environmental Impact
- (h) Demolition of Buildings and Structures
- (i) Underpinning of Buildings and Structures

- (j) Construction near high risks areas, e.g. petrol stations, ammunition stores, power plants, dump sites and etc.
 - (k) Risk associated with future provisions
 - (l) Risk associated with known future provisions
 - (m) Highlight hazards that cannot be eliminated through design of permanent structures and requires mitigation measures during construction
 - (n) Highlight maintenance hazards and their proposed operation measures (A separate Civil DSS focusing on the maintenance hazards shall be prepared as highlighted in Clause 2.1.3)
 - (o) Major risk to workers and public
 - (p) Specific compliance requirements during construction for safety and health
- (iii) Hazard and Risk Management Process
- (a) A description on the roles and responsibilities in the review and acceptance of the mitigation measures
 - (b) The hazard and risk mitigation process shall demonstrate that the high- level hazards have been assessed and that there is no hazard with residual “Intolerable” risk categorisation after the proposed mitigation measures.

2.1.3

The Civil DSS for maintenance hazards shall highlight design provisions for safe maintenance of civil infrastructure, architecture fittings / finishes and E&M equipment and fittings, as well as address the major high level maintenance risks. It shall include, but not limited to, the following:

- (i) Falling from height;
- (ii) Overloading of slab (including equipment delivery and replacement routes);
- (iii) Lifting (focusing on permanent lifting hooks, beams, lifting machines / equipment or cranes provided for maintenance purposes);
- (iv) Working in confined space;
- (v) Fire / explosion (storage / handling of hazardous substances / materials);
- (vi) Ergonomics (posture of workers during maintenance);

(vii) Health (noise, heat and etc); and

(viii) Others.

2.1.4 The Civil DSS for maintenance hazards shall be subsequently transferred to Civil Handover Safety Submission (Civil HSS) to be handover to the operator.

2.2 Civil Construction Safety Submission (CIVIL CNSS)

2.2.1 The objective of the Civil CNSS is to demonstrate that the residual hazards transferred from the Civil DSS have been mitigated during construction phase in the specific contract and that the Contractor has in place the necessary arrangement for managing safety risks.

2.2.2 The fundamental information to be provided in the Civil CNSS is the construction health and safety plan that shall include but not limited to the following areas:

- (i) An executive summary report highlighting the major areas of concerns and the status of findings.
- (ii) Description of contract work and scope:
 - Major work description and scope;
 - Programme details; and
 - Brief details of subcontractors and other consultants.
- (iii) Communication and management of the work:
 - Contractor's Safety Management System prepared according to the guideline of CP 79. The element on emergency preparedness shall include a flood protection plan, a fire safety plan, etc;
 - Arrangement for monitoring and review of health and safety performance; and
 - Arrangement for the exchange of design information between the developer, designer and contractors.
- (iv) Hazard management covering:
 - Proposed mitigation measures of the residual risk transferred from the Civil DSS;
 - Temporary works design such as temporary support structure, false work system, design of decking for support of road traffic, etc;

PS-A-240

- Further major hazards identified by the Contractor (besides residual hazards transferred from Civil DSS) and proposed mitigation measures for these identified “new” hazards. The information shall highlight the major construction hazards that are specific to the contract locality; and
- Other envisaged significant health & safety risk during the construction process and its mitigation measures.

(v) Environmental control plan (in compliance with ISO 14000).

2.2.3 The Civil CNSS shall not focus on common construction work activities such as heavy lifting, hot works, form work erection and etc. These routine construction work activities shall be addressed through method statements.

2.3 Civil Handover Safety Submission (Civil HSS)

2.3.1 The objective of the Civil HSS is to provide the operator/maintenance agencies the necessary information on maintenance hazards and those residual hazards or information that are relevant to the health and safety of any future construction work, which includes cleaning, maintenance, alterations, refurbishment and demolition.

2.3.2 The fundamental information to be provided in the HSS is the Health and Safety File that shall include but not limited to the following areas:

- (i) An executive summary report highlighting the major areas of concerns and status of findings.
- (ii) Summary list of information and final as-built drawings of the structure, including safe working loads for floors and roofs.
- (iii) Key structural principles incorporated in the design of the structure.
- (iv) Schedule of hazardous substances and location of where they are used, if any.
- (v) Information on:
 - Maintenance hazards, including hazardous areas;
 - Specialist manuals for operating and maintenance and replacement purposes; and
 - Fragile materials that maintainer must exercise additional precautions.
- (vi) Hazards that should be considered during future construction work on or nearby the premises.

3. Risk Management Facilitator (RMF) / Designed For Safety Professional (DfS Professional) for the Hazard Identification and Risk Management Process

3.1 Contractor shall propose and engage a qualified and competent RMF / DfS Professional. The qualifications of RMF / DfS Professional proposed for this contract shall include:

- (i) Reasonable exposure in safety and health for construction especially on transportation infrastructure projects in a similar nature to this Contract, and
- (ii) Attended the DfS for Professional Course and passed the assessment, or equivalent, and either
 - Be a registered PE or Architect with a Practicing Certificate or
 - Have 10 years relevant experience in the design (at least five (5) years in design which includes contributions to designs, writing specifications) and the supervision of the construction of structures; and
 - Have a degree accepted by Professional Engineers Board (PEB) or Board Of Architects and construction related degree accepted by Singapore Institute of Surveyors and Valuers (SISV) and Society of Project Managers (SPM).

The final approval for the appointed RMF / DfS Professional shall be within the Authority's discretion. The appointed DFS Professional is to perform the necessary duties as part of the delegation of the Authority's duty.

3.2 The RMF / DfS Professional shall facilitate the hazard identification and risk management sessions for the preparations of the Safety Submissions. The Authority shall be invited to attend these sessions as observers. The Authority may send representative(s) to attend if deemed necessary.

3.3 The RMF / DfS Professional shall be the appointed person in-charge of the preparation and submission of the Safety Submissions. The hazard registers are live documents. He shall add new hazards identified, monitor and update the hazards in the register to ensure all hazards are mitigated and closed.

3.4 The RMF / DfS Professional shall attend the Engineer's Project Safety Committee Meetings and any other risk management meetings directed by the Engineer.

4 Risk Matrix, Hazard Register Structure and Hazard Action Form(HAF)

4.1 The Contractor shall prepare the Safety Submissions using the risk matrix given:

Table 1 : Likelihood of Occurrence

No	Likelihood	Rating	Description
1	Almost Certain	5	Likely to occur within the next month. Probability: >90% chance of occurring
2	Likely	4	Likely to occur between 1 to 2 months Probability: 60% to 90% chance of occurring
3	Possible	3	Likely to occur between 3 months to 1 year Probability: 30% to 60% chance of occurring
4	Unlikely	2	Likely to occur between 1 year to 3 years Probability: 10% to 30% chance of occurring
5	Very Unlikely	1	Likely to occur beyond 3 years Probability: <10% chance of occurring

Table 2 : Magnitude of Impact

No	Consequence	Rating	Description(*)
1	Extreme (Catastrophic)	5	Workplace Safety <ul style="list-style-type: none"> Fatality or multiple fatalities and/or events which triggers Commission of Inquiry under the WSH Act; and/or Loss of whole production for greater than 3 days and/or Total loss in excess of \$1 million.
2	Major	4	Workplace Safety <ul style="list-style-type: none"> Total permanent incapacity or Dangerous Occurrences classified under the WSH Act; and/or Damaged to works or plants causing delays of up to 3 days; and/or Total loss in excess of \$250,000 but up to \$1 million.

No	Consequence	Rating	Description(*)
3	Moderate	3	Workplace Safety <ul style="list-style-type: none"> MOM reportable accident (More than 3 days MC) or Occupational Diseases; and/or Damage to works or plants causing delays of up to 1 day; and/or, Total loss in excess of \$25,000 but up to \$250,000.
4	Minor	2	Workplace Safety <ul style="list-style-type: none"> Minor injuries, MOM reportable accident (3 days or lesser MC or light duties); and/or Damage to works or plants does not cause significant delays; and/or Total loss of up to \$25,000.
5	Insignificant	1	Workplace Safety <ul style="list-style-type: none"> First aid cases (e.g. minor scratches) Damage to works or plants that causes insignificant delays; and/or Total loss of up to \$1,000.

Note:

(*) If more than one of the descriptions occurs, the severity rating would be increased to the next higher level. Applicable to item numbers 2 and 3 only.

Table 3: Risk Index Matrix

Risk Category			Magnitude of Impact (Severity)				
			1	2	3	4	5
			Insignificant	Minor	Moderate	Major	Extreme
Likelihood of Occurrence (Frequency)	5	Almost Certain	B	B	A	A	A
	4	Likely	C	B	B	A	A
	3	Possible	D	C	B	B	A
	2	Unlikely	D	D	C	C	B
	1	Very Unlikely	D	D	C	C	C

The definitions of the risk indices determined from the Risk Index Assessment Matrix are presented in the table 4.

TABLE 4: Definition of Risk Index

Risk Index	Description	Definition
A (Very High)	Intolerable	Risk shall be reduced by whatever means possible.
B (High)	Undesirable	Risk shall only be accepted if further risk reduction is not practicable.
C (Medium)	Tolerable	Risk shall be accepted subject to demonstration that the level of risk is as low as reasonably practicable.
D (Low)	Acceptable	Risk is acceptable.

- 4.2 For hazards relating to **operation and maintenance**, the Accident Frequency, Accident Severity and the Risk Category shall be in accordance to the definitions given in Table 5, 6, 7 and 8.

Table 5: Accident Frequency

Category	Definition	Frequency Guide
Frequent	Likely to occur often	10 times per year or more
Occasional	Likely to occur several times	Less than 10 times per year but more than once per year
Remote	Likely to occur sometime during the system's operational life	Less than once per year but more than once every 10 years
Improbable	Unlikely to occur but possible	Less than once every 10 years but more than once every 100 years
Incredible	Unlikely to occur	Once every 100 years or less

Table 6: Accident Severity

Category	Definition
HIGH	Multiple fatalities and / or severe injuries
MEDIUM	Single fatality or severe injury, with possible other minor injuries
LOW	Minor injuries or property damage only
NEGLIGIBLE	Property damage only

Table 7: Risk Category

Risk Category		Accident Severity Category			
		Negligible	Low	Medium	High
Accident Frequency Category	Frequent	B	A	A	A
	Occasional	C	B	A	A
	Remote	D	C	B	A
	Improbable	D	D	C	B
	Incredible	D	D	D	C

Table 8: Definition of Risk Categories

Risk Category	Description	Definition
A	Intolerable	Risk shall be reduced by whatever means possible.
B	Undesirable	Risk shall only be accepted by LTA if further risk reduction is not practicable.
C	Tolerable	Risk shall be accepted by LTA subject to endorsement by the PSR Committee (Roads).
D	Acceptable	Risk shall be accepted by LTA.

HAZARD REGISTER STRUCTURE

1			2	3	4	5	6	7			8	9			10	11	12	13	14	15	16	17
Risk ID			Previous Hazard ID	Work Activity	Hazard	Hazard Cause	Impact	Initial Risk Category Ri			Mitigation Measures	Residual Risk Category Rr			Future Actions	Risk Owner	Action Owner	Due Date By	Risk Exposure Period	Target Risk Rating	Status	Remark
Hazard No.	Hazard Code	Running Number						F	S	Ri		F	S	Rr								

Definitions of Terms in the Hazard Log

Column	Field Name	Description
1.	Risk ID	Numbering system and hazard code to refer to details and the list of hazard codes attached in next page.
2.	Previous ID	The hazard number that was previously assigned to the particular hazard before it was transferred to the current hazard register.
3.	Work Activity	Describes the construction activity that may have risks.
4.	Hazard	A situation or circumstance in which there is a potential for an accident to occur that may cause injury or fatality to personnel, or damage to system or environment. For example, toxic fumes are a potential hazard. In many cases, the hazard may be continuously present under normal conditions, referred to as an intrinsic hazard. Note that the hazard is distinct from the accident, but is rather the circumstances in which the accident may occur.
5.	Hazard Cause	The events, circumstances or conditions that result in the creation of the hazard.
6.	Impact	The result of such hazard i.e. type of accident or incident that may happen if this hazard occurs.
7.	Initial Risk Category (Ri)	The initial risk assessed prior to mitigation measures is implemented. This is dependent on the frequency (F) rating and severity (S) rating.
8.	Mitigation Measures	Provision of safeguards/control measures for considerations. The risks should be re-assessed to see if either probability or severity rate has been reduced by the proposed mitigation measures.
9.	Residual Risk Category (Rr)	The risk assessed when the proposed mitigation measures are in place. This is dependent on the frequency (F) rating and severity (S) rating.
10.	Future Actions	These are additional mitigation measures identified but yet to be implemented.
11.	Risk Owner	The person who carries the responsibility for ensuring that the risk is monitored and, where appropriate, effectively managed. They might not be the person who has to do the necessary actions, but they must continuously aware of the risk and closing-out status.
12.	Action Owner	This is assigned to the person who is best able to control the risk mitigation on site.
13.	Due Date By	Timescale when mitigation measures are to be implemented.
14.	Risk Exposure Period	The period the risk will be active for work activity described.
15.	Target Risk Rating	Mitigation rating to be achieved.
16.	Status	Description of current status for the risk, which also include the implementation status for proposed mitigation measures. The status shall be reviewed monthly. Closed-out date shall be recorded against the status.
17.	Remark	Any further comments pertaining to the risks.

**Where the hazards are deleted, the reason for deletion shall be stated clearly in the Hazard Register.

Numbering System:

Contract Number / Site Contract Number / Stage / Hazard Code / Hazard Running Number / Packages

Definition:

- i. **Contract Number:** The Contract number of the A/E or Contractor who prepares the Safety Submission.
- ii. **Site Contract Number:** The contract number of site the safety submission is for.
- iii. **Hazard Code:** The hazard classification codes for the different category of hazards.
- iv. **Hazard Running Number:** The hazard running number based on the category of hazards starting with "001".
- v. **Packages:** This refers to the number of Construction Safety Submissions (CNSS) proposed by the Contractors, usually using alphabets: A, B, C, D and etc. Only applicable to construction stage.

Hazard Classification Reference Codes

Ref	Category
100	Earth Retaining Supporting Structures (ERSS)
101	Temporary Structures
102	Diaphragm Walling/Piling
103	Permanent Structures
104	Ground Conditions
105	Adjacent Structures or buildings
106	Existing Utilities
107	Existing RTS Stations, Tunnels and Viaducts
108	Existing Road Tunnels and Viaducts
109	Obstructions
110	Interface with adjacent contracts
111	Interface with adjacent developments
112	Future developments or Addition & Alteration works
113	Tunnelling
114	Underpinning Works
115	Demolition Works
116	Blasting Works

PS-A-248

117	Construction Methodology
118	Ground Improvements
119	Instrumentation
120	Hazardous Materials
121	Fire & Explosions
122	Flooding
123	Confined Space
124	Architectural/Glazing Works
125	Maintenance
999	Others

Land Transport Authority 	HAZARD ACTION FORM
--	---------------------------

Actionee / Hazard Owner :		Hazard Action Form No:	Hazard No:	Part 1
Additional Actionee / Hazard Owner :		Date Issued	Response Date Due	
Hazard				
Hazard Cause				
Accident Potential				
Initial Accident Risk	Severity:	Accident Frequency:	Risk Class:	

Description Of Action Needed :			Part 2 – Hazard Owner(s)
Actionee(s) Response :			
Name :	Signature :	Date :	

<u>Action Review & Status</u>				Part 3
Decision/Comments On Part 2 :				
Residual Accident Risk	Severity:	Accident Frequency:	Risk Class:	
Name :	Signature :	Date :		
Subsequent Action Raised : <input type="checkbox"/> Yes ⇒ Action No. : <input type="checkbox"/> No				

BUILD ONLY ROAD PROJECTS CIVIL DESIGN SAFETY SUBMISSIONS

1 Introduction

- 1.1 The Contractor shall be required to prepare and submit risk assessment reports for the following stages of the project life cycle:
- (i) Pre-construction Stage
 - (ii) Project Handover
- 1.2 The Contractor shall be given a copy of a Civil Design Safety Submission prepared by the Authority or its Consultant. The Contractor shall use it as a base for the preparation of the Civil Construction Safety Submissions (Civil CNSS). The CNSS can be submitted in accordance to structural packages and shall be submitted to the Engineer two (2) months before application for permit to excavate; or two (2) months before making structural submission to the Building and Construction Authority (BCA) for temporary works. The Engineer shall decide on the final timing for the CNSS submission.
- 1.3 The Contractor shall also prepare and submit a Civil Handover Safety Submission (Civil HSS). The Civil HSS shall be submitted four (4) months before the end of the defects liability period (DLP) of the contract.
- 1.4 The Accident Frequency, Accident Severity and Risk Index for the risk assessment and Hazard Register Structure for the Civil DSS, CNSS and the HSS shall be in compliance with Clause 4 of this Annex.
- 1.5 The Civil CNSS and HSS shall be subjected to the acceptance of the Engineer. The Contractor shall make amendments and revise the Safety Submissions in accordance with the Engineer's instructions.

2 Safety Submissions

- 2.1 Civil Construction Safety Submission (CIVIL CNSS)
- 2.1.1 The objective of the Civil CNSS is to demonstrate that the residual hazards transferred from the Civil DSS have been mitigated during construction phase in the specific contract and that the Contractor has in place the necessary arrangement for managing safety risks.
- 2.1.2 The fundamental information to be provided in the Civil CNSS is the construction health and safety plan that shall include but not limited to the following areas:

- (i) An executive summary report highlighting the major areas of concerns and the status of findings.
- (ii) Description of contract work and scope:
 - Major work description and scope;
 - Programme details; and
 - Brief details of subcontractors and other consultants.
- (iii) Communication and management of the work:
 - Contractor's Safety Management System prepared according to the guideline of CP 79. The element on emergency preparedness shall include a flood protection plan, a fire safety plan, etc;
 - Arrangement for monitoring and review of health and safety performance; and
 - Arrangement for the exchange of design information between the developer, designer and contractors.
- (iv) Hazard management covering:
 - Proposed mitigation measures of the residual risk transferred from the Civil DSS;
 - Temporary works design such as temporary support structure, false work system, design of decking for support of road traffic, etc;
 - Further major hazards identified by the Contractor (besides residual hazards transferred from Civil DSS) and proposed mitigation measures for these identified "new" hazards. The information shall highlight the major construction hazards that are specific to the contract locality; and
 - Other envisaged significant health & safety risk during the construction process and its mitigation measures.
- (v) Environmental control plan (in compliance with ISO 14000).

2.1.3

The Civil CNSS shall not focus on common construction work activities such as heavy lifting, hot works, form work erection and etc. These routine construction work activities shall be addressed through method statements.

- 2.2 Civil Handover Safety Submission (Civil HSS)
- 2.2.1 The objective of the Civil HSS is to provide the operator/maintenance agencies the necessary information on maintenance hazards and those residual hazards or information that are relevant to the health and safety of any future construction work, which includes cleaning, maintenance, alterations, refurbishment and demolition.
- 2.2.2 The fundamental information to be provided in the HSS is the Health and Safety File that shall include but not limited to the following areas:
- (i) An executive summary report highlighting the major areas of concerns and status of findings.
 - (ii) Summary list of information and final as-built drawings of the structure, including safe working loads for floors and roofs.
 - (iii) Key structural principles incorporated in the design of the structure.
 - (iv) Schedule of hazardous substances and location of where they are used, if any.
 - (v) Information on:
 - Maintenance hazards, including hazardous areas;
 - Specialist manuals for operating and maintenance and replacement purposes; and
 - Fragile materials that maintainer must exercise additional precautions.
 - (vi) Hazards that should be considered during future construction work on or nearby the premises.
- 3 Risk Management Facilitator (RMF) / Designed For Safety Professional (DfS Professional) for the Hazard Identification and Risk Management Process**
- 3.1 Contractor shall propose and engage a qualified and competent RMF / DfS Professional. The qualifications of RMF / DfS Professional proposed for this contract shall include:
- (i) Reasonable exposure in safety and health for construction especially on transportation infrastructure projects in a similar nature to this Contract, and
 - (ii) Attended the DfS for Professional Course and passed the assessment, or equivalent, and either

- Be a registered PE or Architect with a Practicing Certificate or
- Have 10 years relevant experience in the design (at least five (5) years in design which includes contributions to designs, writing specifications) and the supervision of the construction of structures; and
- Have a degree accepted by Professional Engineers Board (PEB) or Board Of Architects and construction related degree accepted by Singapore Institute of Surveyors and Valuers (SISV) and Society of Project Managers (SPM).

The final approval for the appointed RMF / DfS Professional shall be within the Authority's discretion. The appointed DFS Professional is to perform the necessary duties as part of the delegation of the Authority's duty.

- 3.2 The RMF / DfS Professional shall facilitate the hazard identification and risk management sessions for the preparations of the Safety Submissions. The Authority shall be invited to attend these sessions as observers. The Authority may send representative(s) to attend if deemed necessary.
- 3.3 The RMF / DfS Professional shall be the appointed person in-charge of the preparation and submission of the Safety Submissions. The hazard registers are live documents. He shall add new hazards identified, monitor and update the hazards in the register to ensure all hazards are mitigated and closed.
- 3.4 The RMF / DfS Professional shall attend the Engineer's Project Safety Committee Meetings and any other risk management meetings directed by the Engineer.

4 Risk Matrix, Hazard Register Structure and Hazard Action Form (HAF)

4.1 The Contractor shall prepare the Safety Submissions using the risk matrix given:

Table 1 : Likelihood of Occurrence

No	Likelihood	Rating	Description
1	Almost Certain	5	Likely to occur within the next month. Probability: >90% chance of occurring
2	Likely	4	Likely to occur between 1 to 2 months Probability: 60% to 90% chance of occurring
3	Possible	3	Likely to occur between 3 months to 1 year Probability: 30% to 60% chance of occurring
4	Unlikely	2	Likely to occur between 1 year to 3 years Probability: 10% to 30% chance of occurring
5	Very Unlikely	1	Likely to occur beyond 3 years Probability: <10% chance of occurring

Table 2 : Magnitude of Impact

No	Consequence	Rating	Description(*)
1	Extreme (Catastrophic)	5	Workplace Safety <ul style="list-style-type: none"> Fatality or multiple fatalities and/or events which triggers Commission of Inquiry under the WSH Act; and/or Loss of whole production for greater than 3 days and/or Total loss in excess of \$1 million.
2	Major	4	Workplace Safety <ul style="list-style-type: none"> Total permanent incapacity or Dangerous Occurrences classified under the WSH Act; and/or Damaged to works or plants causing delays of up to 3 days; and/or Total loss in excess of \$250,000 but up to \$1 million.

No	Consequence	Rating	Description(*)
3	Moderate	3	Workplace Safety <ul style="list-style-type: none"> MOM reportable accident (More than 3 days MC) or Occupational Diseases; and/or Damage to works or plants causing delays of up to 1 day; and/or, Total loss in excess of \$25,000 but up to \$250,000.
4	Minor	2	Workplace Safety <ul style="list-style-type: none"> Minor injuries, MOM reportable accident (3 days or lesser MC or light duties); and/or Damage to works or plants does not cause significant delays; and/or Total loss of up to \$25,000.
5	Insignificant	1	Workplace Safety <ul style="list-style-type: none"> First aid cases (e.g. minor scratches) Damage to works or plants that causes insignificant delays; and/or Total loss of up to \$1,000.

Note:

(*) If more than one of the descriptions occurs, the severity rating would be increased to the next higher level. Applicable to item numbers 2 and 3 only.

Table 3: Risk Index Matrix

Risk Category			Magnitude of Impact (Severity)				
			1	2	3	4	5
			Insignificant	Minor	Moderate	Major	Extreme
Likelihood of Occurrence (Frequency)	5	Almost Certain	B	B	A	A	A
	4	Likely	C	B	B	A	A
	3	Possible	D	C	B	B	A
	2	Unlikely	D	D	C	C	B
	1	Very Unlikely	D	D	C	C	C

The definitions of the risk indices determined from the Risk Index Assessment Matrix are presented in the table 4.

TABLE 4: Definition of Risk Index

Risk Index	Description	Definition
A (Very High)	Intolerable	Risk shall be reduced by whatever means possible.
B (High)	Undesirable	Risk shall only be accepted if further risk reduction is not practicable.
C (Medium)	Tolerable	Risk shall be accepted subject to demonstration that the level of risk is as low as reasonably practicable.
D (Low)	Acceptable	Risk is acceptable.

- 4.2 For hazards relating to **operation and maintenance**, the Accident Frequency, Accident Severity and the Risk Category shall be in accordance to the definitions given in Table 5, 6, 7 and 8.

Table 5: Accident Frequency

Category	Definition	Frequency Guide
Frequent	Likely to occur often	10 times per year or more
Occasional	Likely to occur several times	Less than 10 times per year but more than once per year
Remote	Likely to occur sometime during the system's operational life	Less than once per year but more than once every 10 years
Improbable	Unlikely to occur but possible	Less than once every 10 years but more than once every 100 years
Incredible	Unlikely to occur	Once every 100 years or less

Table 6: Accident Severity

Category	Definition
HIGH	Multiple fatalities and / or severe injuries
MEDIUM	Single fatality or severe injury, with possible other minor injuries
LOW	Minor injuries or property damage only
NEGLIGIBLE	Property damage only

Table 7: Risk Category

Risk Category		Accident Severity Category			
		Negligible	Low	Medium	High
Accident Frequency Category	Frequent	B	A	A	A
	Occasional	C	B	A	A
	Remote	D	C	B	A
	Improbable	D	D	C	B
	Incredible	D	D	D	C

Table 8: Definition of Risk Categories

Risk Category	Description	Definition
A	Intolerable	Risk shall be reduced by whatever means possible.
B	Undesirable	Risk shall only be accepted by LTA if further risk reduction is not practicable.
C	Tolerable	Risk shall be accepted by LTA subject to endorsement by the PSR Committee (Roads).
D	Acceptable	Risk shall be accepted by LTA.

HAZARD REGISTER STRUCTURE

1			2	3	4	5	6	7			8	9			10	11	12	13	14	15	16	17
Risk ID			Previous Hazard ID	Work Activity	Hazard	Hazard Cause	Impact	Initial Risk Category Ri			Mitigation Measures	Residual Risk Category Rr			Future Actions	Risk Owner	Action Owner	Due Date By	Risk Exposure Period	Target Risk Rating	Status	Remark
Hazard No.	Hazard Code	Running Number						F	S	Ri		F	S	Rr								

Definitions of Terms in the Hazard Log

Column	Field Name	Description
1.	Risk ID	Numbering system and hazard code to refer to details and the list of hazard codes attached in next page.
2.	Previous ID	The hazard number that was previously assigned to the particular hazard before it was transferred to the current hazard register.
3.	Work Activity	Describes the construction activity that may have risks.
4.	Hazard	A situation or circumstance in which there is a potential for an accident to occur that may cause injury or fatality to personnel, or damage to system or environment. For example, toxic fumes are a potential hazard. In many cases, the hazard may be continuously present under normal conditions, referred to as an intrinsic hazard. Note that the hazard is distinct from the accident, but is rather the circumstances in which the accident may occur.
5.	Hazard Cause	The events, circumstances or conditions that result in the creation of the hazard.
6.	Impact	The result of such hazard i.e. type of accident or incident that may happen if this hazard occurs.
7.	Initial Risk Category (Ri)	The initial risk assessed prior to mitigation measures is implemented. This is dependent on the frequency (F) rating and severity (S) rating.
8.	Mitigation Measures	Provision of safeguards/control measures for considerations. The risks should be re-assessed to see if either probability or severity rate has been reduced by the proposed mitigation measures.
9.	Residual Risk Category (Rr)	The risk assessed when the proposed mitigation measures are in place. This is dependent on the frequency (F) rating and severity (S) rating.
10.	Future Actions	These are additional mitigation measures identified but yet to be implemented.
11.	Risk Owner	The person who carries the responsibility for ensuring that the risk is monitored and, where appropriate, effectively managed. They might not be the person who has to do the necessary actions, but they must continuously aware of the risk and closing-out status.
12.	Action Owner	This is assigned to the person who is best able to control the risk mitigation on site.
13.	Due Date By	Timescale when mitigation measures are to be implemented.
14.	Risk Exposure Period	The period the risk will be active for work activity described.
15.	Target Risk Rating	Mitigation rating to be achieved.
16.	Status	Description of current status for the risk, which also include the implementation status for proposed mitigation measures. The status shall be reviewed monthly. Closed-out date shall be recorded against the status.
17.	Remark	Any further comments pertaining to the risks.

**Where the hazards are deleted, the reason for deletion shall be stated clearly in the Hazard Register.

Numbering System:

Contract Number / Site Contract Number / Stage / Hazard Code / Hazard Running Number / Packages

Definition:

- i. **Contract Number:** The Contract number of the A/E or Contractor who prepares the Safety Submission.
- ii. **Site Contract Number:** The contract number of site the safety submission is for.
- iii. **Hazard Code:** The hazard classification codes for the different category of hazards.
- iv. **Hazard Running Number:** The hazard running number based on the category of hazards starting with "001".
- v. **Packages:** This refers to the number of Construction Safety Submissions (CNSS) proposed by the Contractors, usually using alphabets: A, B, C, D and etc. Only applicable to construction stage.

Hazard Classification Reference Codes

Ref	Category
100	Earth Retaining Supporting Structures (ERSS)
101	Temporary Structures
102	Diaphragm Walling/Piling
103	Permanent Structures
104	Ground Conditions
105	Adjacent Structures or buildings
106	Existing Utilities
107	Existing RTS Stations, Tunnels and Viaducts
108	Existing Road Tunnels and Viaducts
109	Obstructions
110	Interface with adjacent contracts
111	Interface with adjacent developments
112	Future developments or Addition & Alteration works
113	Tunnelling

PS-A-260

114	Underpinning Works
115	Demolition Works
116	Blasting Works
117	Construction Methodology
118	Ground Improvements
119	Instrumentation
120	Hazardous Materials
121	Fire & Explosions
122	Flooding
123	Confined Space
124	Architectural/Glazing Works
125	Maintenance
999	Others

Land Transport  Authority	HAZARD ACTION FORM
--	---------------------------

Actionee / Hazard Owner :		Hazard Action Form No:	Hazard No:	Part 1
Additional Actionee / Hazard Owner :		Date Issued	Response Date Due	
Hazard				
Hazard Cause				
Accident Potential				
Initial Accident Risk	Severity:	Accident Frequency:	Risk Class:	

Description Of Action Needed :	Part 2 – Hazard Owner(s)
Actionee(s) Response :	
Name : Signature : Date :	

<u>Action Review & Status</u>				Part 3
Decision/Comments On Part 2 :				
Residual Accident Risk	Severity:	Accident Frequency:	Risk Class:	
Name :	Signature :	Date :		
Subsequent Action Raised : <input type="checkbox"/> Yes ⇒ Action No. : <input type="checkbox"/> No				

PROTECTION OF SLAB OPENINGS

1.0 Classification of Openings

1.1 The Contractor shall note that the slab openings on site shall comprise of varying sizes and are categorised into three (3) groups.

- 1) Group 1: 300mm wide x any length:
Too narrow for a person to fall through, but wider than their foot and therefore possible to fall into with potential injuries to shin, knee, thigh or hip.
- 2) Group 2: 300mm – 1000mm wide x any length:
Big enough to fall through, with potentially serious consequences, but too small to be of use as a service opening. Sumps, pits and future access hatches are excluded from this group and shall be treated as Group 3 openings.
- 3) Group 3: Greater than 1000mm x any length:
Stairwells, air shafts and service openings are the most common in this category.

2.0 Treatment of Openings

2.1 For each group of openings, the Contractor shall comply with the 'standard' solution stipulated in this Section.

- 1) Group 1: 300mm wide x any length:
A plywood cover (12 or 18mm thick) bolted or nailed down. Cover to be painted in a distinctive colour or pattern.

PS-A-263

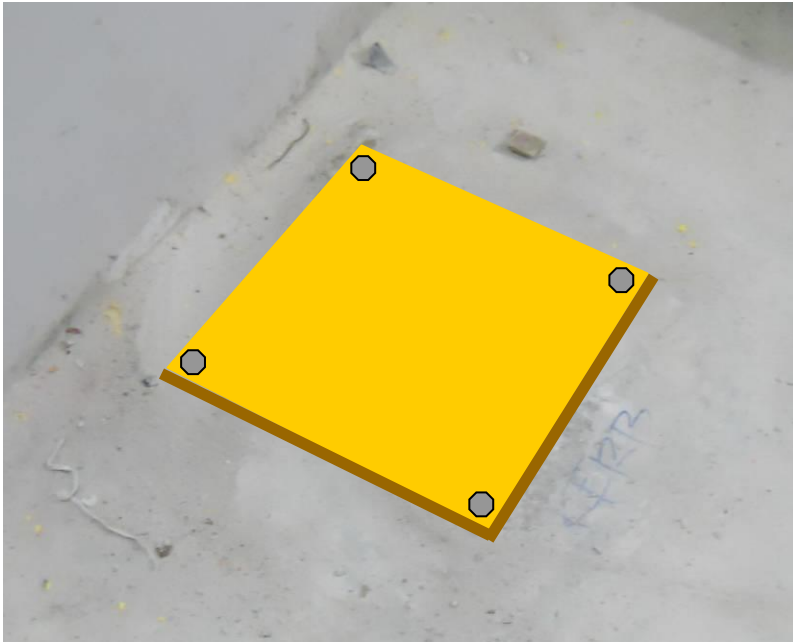

Note: Yellow was chosen because is distinctive, but any colour or pattern can be adopted.

2) Group 2: 300mm – 1000mm wide x any length:

A13 mesh, fixed to the top steel and cast into the slab. After casting, a plywood cover can be fitted and secured to prevent debris from falling through.



Mesh cast with slab provides immediate protection against fall and cannot be accidentally removed. Design load on A13 mesh has to be taken as 1.5KN. This is a commonly used load in 'Dead and Live Load Tables' for human traffic. Mesh is capable of spanning 1200mm under 1.5KN, but has been limited to 1000mm. Mesh to be hot dipped galvanised.

Embedment length to be 425mm in short span direction.



Cover fitted to prevent debris and materials from falling through. If cover is removed or becomes damaged the opening is still secure. Cover should be cut to fit inside the opening thus reducing the trip hazard and also allowing other works to pass over it.

- 2.4 Group 3: Greater than 1000mm x any length:
Standard method of railings, toeboards and netting shall be provided, with the height of railings to be at least 1.1m high.



Barricade shown above is meant to protect against people. It is not appropriate for use where vehicle movement is expected. A properly designed steel structure is recommended in such situations.

3.0 Removal of Mesh

- 3.1 The Contractor shall note that the Stop-end below the mesh should be removed during striking of formwork. Stop-end above the mesh could be removed at the same time or left to serve as a stop-end for future screeding works (if any). Plywood cover can be cut to suit.
- 3.2 Removal of mesh shall be undertaken by the Contractor only when the opening is required by the relevant owner. As the relevant owner is usually a SWC it is intended that the mesh be removed only when requested by them. It should not be removed during room handover.
- 3.3 After removing the mesh, the Contractor should grind the remnant steel flush to the opening and make good to the exposed ends using an acceptable anti-corrosion treatment (e.g. cold galvanised paint, epoxy paint, etc.)

SAFE INSTALLATION AND MAINTENANCE OF SLIDING GATES (BOTH PERMANENT AND TEMPORARY**)

General

- 1.1 The sliding gate shall be fully fabricated in the factory prior to delivery and installation on site.
- 1.2 In the process of installation, the contractor shall provide temporary restraint to prevent any movement (that can result in overrun and toppling) of the gate until its full installation with all safety features (e.g. stoppers to prevent over-run, gate safety sensors etc.) are completed.



Sliding gate restrained from movement by securing to gate post.

- 1.3 The work zone surrounding the installation of the sliding gate must be cordoned off with rigid barricades to prevent any unauthorized personnel from approaching.



Cordon off work zone around gate installation

- 1.4 The manufacturer / supplier / builder of sliding gate shall provide to the Contractor the operational manual for safe operation and maintenance of the gate.
- 1.5 All sliding gates should be checked and maintained periodically according to the manufacturer supplier / builder's recommendation. In addition, the track for the gate should be properly maintained to prevent any accumulation of debris which could cause the sliding gate to derail.
- 1.6 The Contractor shall comply with recommendations from "Circular on Safety Considerations in Gate Design and Operation" issued by the Ministry of Manpower and Building Construction Authority dated 1st March 2012.

** Temporary sliding gates refers to gates installed in conjunction with site hoarding around the worksite boundary

Photographs Highlighting Good SHE Practices

(For Compliance on Site)



Examples of Step Platforms
Source: Google images



Examples of Step Platforms being used on site



Steel staircase with unobstructed headroom and netting wrapped around handrail and underneath of steps to prevent loose material from falling through



Handrails (top and intermediate)

Proper handrails provided at designated site access and walkways. Toe board and netting are added to prevent loose material from falling over



Handrails (top and intermediate)

Proper handrails provided at designated site access and walkways. Toe board are added to prevent loose material from falling over. Netting added to prevent loose material from falling down



Platform with handrails provided for signalman to stand on strut to co-ordinate lifting operation

PS-A-272



Floor opening cover is flushed and secured against moving



Lifting activity is cordoned off and warning signage is placed to warn personnel against entering the area



Lifting activity is cordoned off and warning signage is placed to warn personnel against entering the area



Crane access lined with closely decked steel plates to ensure stability of crane



Crane access lined with closely decked steel plates to ensure stability of crane



Lifting gears properly stored and maintained in good condition

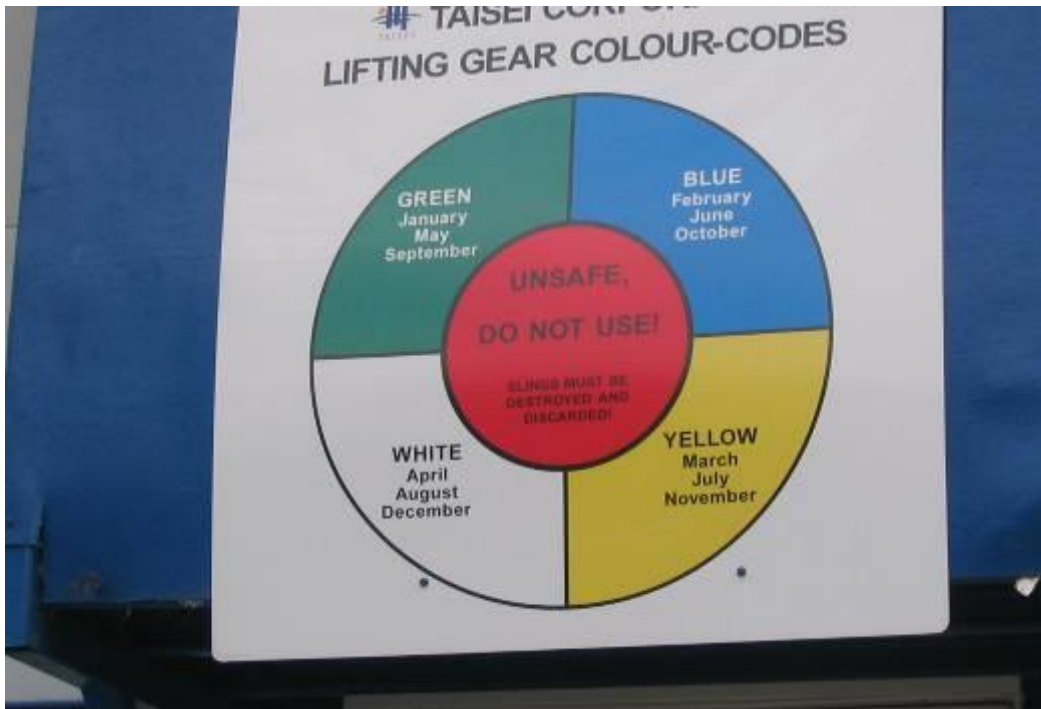

Colour code system implemented to ensure lifting gear is checked thoroughly every month before use



Ventilation fan with fixed mechanical guard to prevent fingers from coming into contact with the moving fan blades

PS-A-276



Sticker label to indicate that powered tool has been checked regularly by LEW



Drill with ATC safety feature has an electronic device to sense the jamming of the drill bit and disconnect motor axle from gear

Powered drill with Active Torque Control (ATC) safety feature (or equivalent) to prevent uncontrolled spinning of drill when drill bit gets jammed. The uncontrolled spinning can cause injury to operator



Proper cable hangers use to hang up cables



Flammable substance stored at designated storage area with warning signage. Area is locked to prevent unauthorized removal of substance

PS-A-278



Gas cylinders secured in a cylinder trolley to prevent toppling



Fire fighting and first aid equipment readily available at strategic locations



Height Limit Gantry installed at site entrance / exit to ensure the total height of the vehicle does not exceed 4.5m



Site entrance equipped with revolving light and convex mirror to enhance pedestrian safety. Full-time banksman deployed to guide vehicles exiting the worksite



Overhead shelter provided when work is carried out near hoarding to protect the public from any falling objects



“See through fencing” allows pedestrian to check and ensure vehicles has stopped before crossing at traffic junction



Concrete barriers use to protect workers against the possibility of vehicles crashing into site boundary



Good housekeeping around worksite



Good housekeeping at worksite with designated areas for storage and walkway



Good housekeeping at worksite with designated areas for storage and walkway

PS-A-283



Good housekeeping at worksite with designated areas for storage and walkway



Good housekeeping. Material storage area separate from walkway



Tunnel is well illuminated



Continuous walkway with guardrail provided along the tunnel



Telephone provided at regular interval along tunnel to notify of any emergency



Fire hose reel provided at regular interval along tunnel for fire fighting purpose



Red and Green signal light to regulate locomotive movement in the tunnel



Locomotive equip with camera to monitor rear view

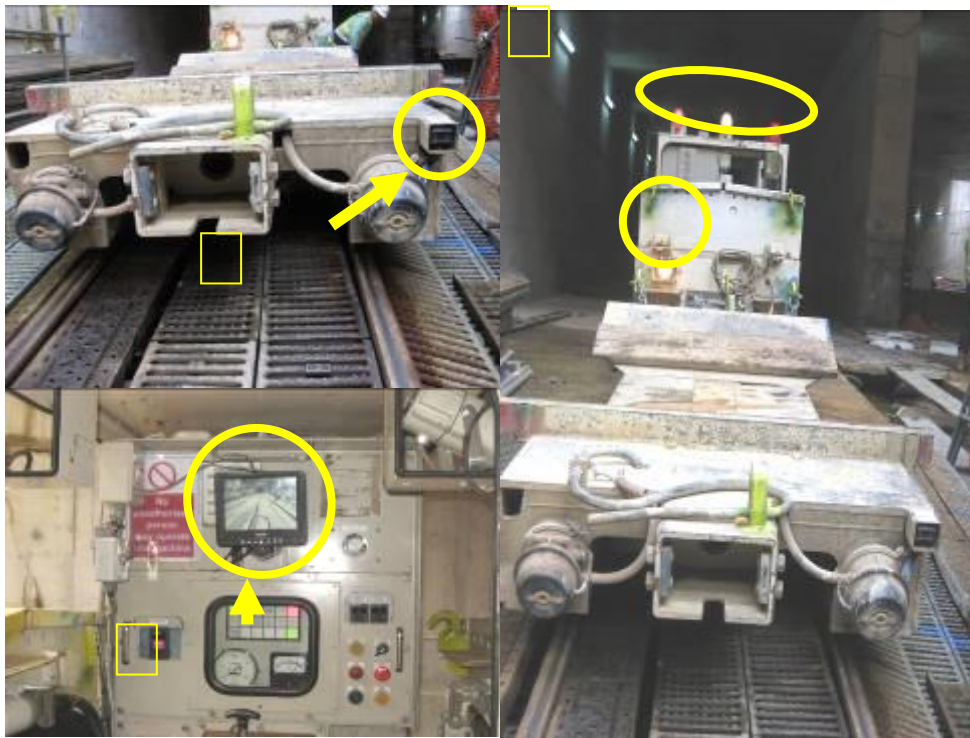

Locomotive equip with camera and monitor for rear view.



Good illumination and housekeeping maintained underneath TBM Back-up gantry cars



Manchester gate

Manchester gate installed to regulate movement of locomotive in tunnel

PS-A-288



Proper First Aid room equipped with standard first aid items, stretcher and bed



Proper rest areas with tables and chairs provided



Proper rest areas with tables and chairs provided



Proper rest areas with tables and chairs provided

PS-A-290



Water cooler provided at worksite



Stage provided for safety promotional events



Safety promotion corner – Display of exhibits to communicate safety requirements



Coloured Safety posters / articles displayed to communicate safety requirements

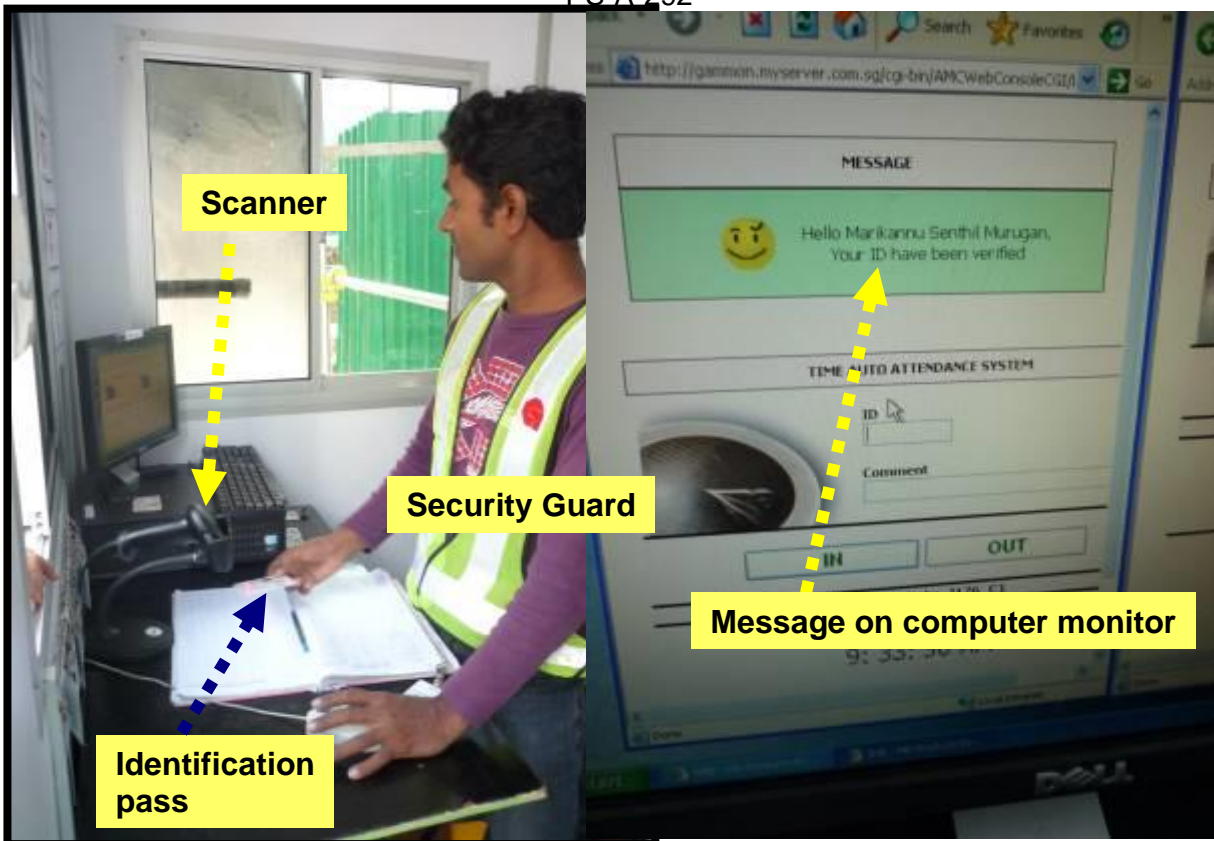

Electronic scanner use to keep track of personnel entering and leaving worksite



Access control to Tunnel using finger print. This method eliminate the problem of forgetting to bring or loss of identification tags



Security pass exchange area separated from vehicle access to prevent vehicles driving too near and injuring workers reporting at the security post



Roller gate at the entrance has an advantage over hinged gate as it eliminates the accidental swinging of gate that can result in hitting man or vehicle

PS-A-294



Use of bund wall to protect silty runoff from entering the public drain



Adequate use of turbidity curtain for works near waterbodies / waterways



Full acoustic enclosures used for permanent work areas (E.g. launch shafts). Where a full enclosure is not possible, an acoustic enclosure with the opened face oriented away from any residential/ sensitive premises and covered with retractable noise barrier shall be considered.

PS-A-296



Full acoustic enclosures designed with air ventilation system and adequate space for plants and machineries to manoeuvre



Large acoustic enclosures on slurry treatment plants



Large acoustic enclosures on desanding plants



Large acoustic enclosures used for noisy activities / machineries (For e.g. excavation activities, launch shaft) conducted near noise sensitive receivers)



Use of celcon block walls with built-in rockwool to house noisy ventilation fan



**Use of noise enclosures for noisy machineries
(For e.g. power-pack generator)**

PS-A-299



Noise enclosure on D-wall cutter machine

PS-A-300



Noise enclosure on boring rigs



Noise enclosure on D-wall cutter for ventilation fans

PS-A-301



Use of sound-reduced machinery



Use of silent-piling machine (for suitable soil conditions)

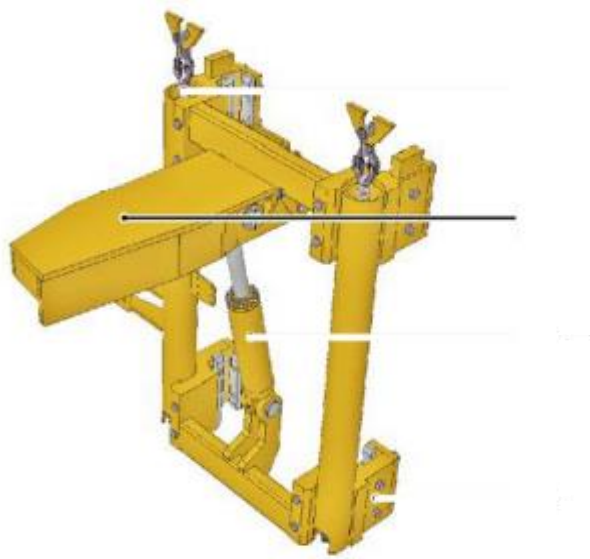

An auger cleaner tool can be installed onto the existing boring rig. This tool is built with a reamer arm to scrap off the soil / residue retaining on the auger after boring. The benefits of using the auger cleaner include 1) reduce noise and 2) clean small auger flights with sticky soil.

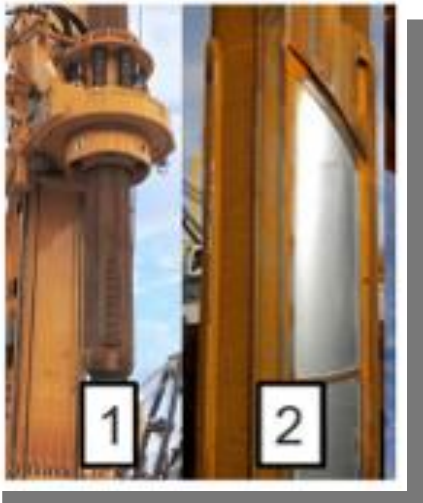

The noise damping system can be applicable to all Kelly bars. It consists of sound absorbing pads which are glued onto the exterior surface of the outer Kelly bar section, and these pads are protected against mechanical damage by metal sheets. The system mainly reduces the disturbing high frequency noise that are generated by the jerky Kelly bar movements and amplified by individual hollow Kelly bar sections clanging with each other.



Use of modified auger bucket (suitable for sticky soil conditions)

Modification of auger bucket involves:

- Introducing a sliding steel plate separator
- Creating two separate chambers with associated cutter
- With this modification, soil discharge can be done simply using spinning action alone

Sliding steel plate separator will drop like a trap door, pulling down stuck soil by gravity and allow the use of centrifugal force to spin out the soil, instead of using inertia in the usual spin and lock method to discharge soil in the standard auger bucket. This thus results in a reduction of the high-pitched intermittent “metal-clanking” noise level from 97dB (5m from the source) to 83dB.

PS-A-304



Use of portable noise barriers around noisy works such as bore piling

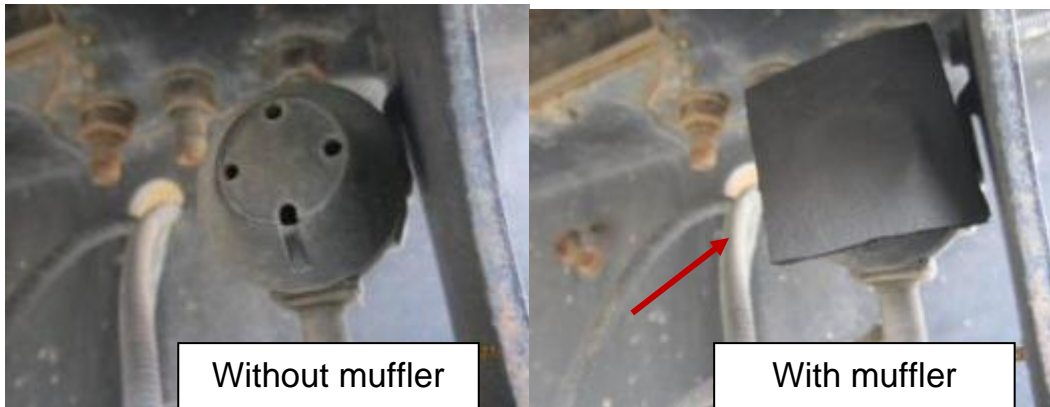

Use of absorptive material to muffle beepers of trucks entering the site to a suitable volume.

PS-A-305



'Canvas 'noise' curtains that do not meet the STC requirement shall not be used as the primary noise mitigation measure.

PS-A-306



Provision of adequate and sheltered bins for containment of wastes

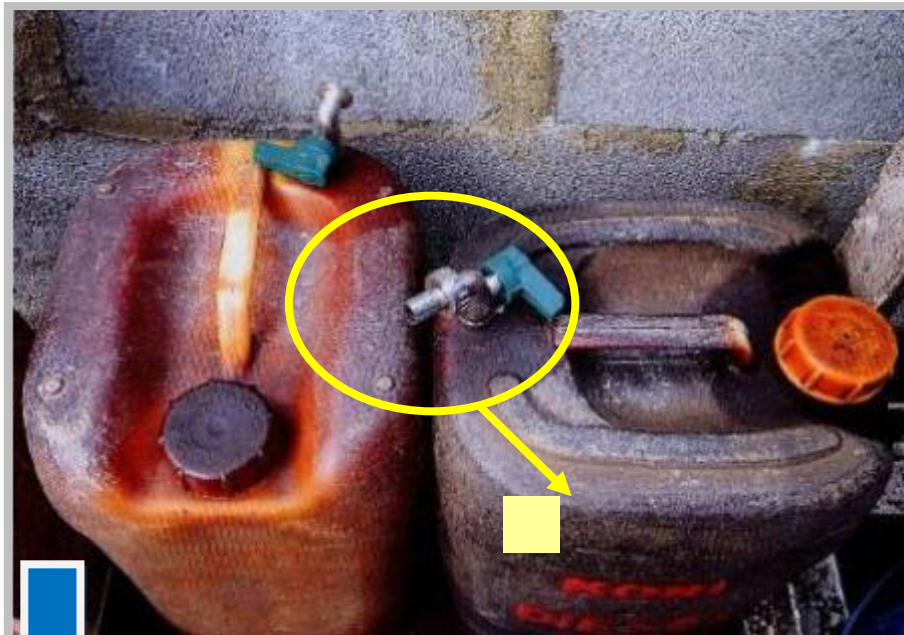

Use of valve during diesel refill

By having this valve, diesel refill can be done in a more controllable manner thus preventing spillage.

PS-A-308



Arresting of dust at source using recycled water



Use of 'green' hoardings to beautify the site and to reduce the impact from traffic carbon emissions

Mobile Elevated Working Platform (MEWP) Usage On Site

PS-A-310

- 1.1 The contractor shall ensure all MEWPs used on site are fitted with an additional locking device to prevent unauthorised usage. The additional locking device implemented shall be approved by the MEWP manufacturer or supplier.
- 1.2 The additional locking device will be included in the daily pre-operational checklist and shall be checked by the operator before usage. The MEWPs shall not be allowed to be used once the additional locking device is found damaged.
- 1.3 The contractor shall ensure no modification to the MEWP ignition keyholes and main power disconnect switch system.
- 1.4 The contractor shall ensure barricades are provided for the MEWPs' working zone. In addition, a banksman shall be provided to control MEWP movement on site.
- 1.5 The contractor shall ensure add-on safety devices such as purpose-designed guards, pressure bars or proximity sensors on the MEWP are approved by the machine manufacturer or supplier.

ANNEX A-t

ELECTRONIC SAFETY, HEALTH AND ENVIRONMENTAL MANAGEMENT SYSTEM (e-SHEMS)

1. The e-SHEMS shall be implemented to improve data management, productivity and reduce the usage of paper. The system shall be able to perform but not limited to the following functions and accessible via mobile devices:
 - a) Generate inspection checklist and report with the ability to attached photograph.
 - b) Generate, submit and process paperless Permit-To-Work (e-PTW) System.
 - c) Generate and submit Near-miss / Incident / Accident Report.
2. The information captured in e-PTW, checklist or report shall include but not limited to the date and time, work location, project description, name of inspector, applicant, reviewer, approver, pictures, action taken and remark (if applicable)
3. The e-PTW, checklist or report shall be validated and approved within specified timeframe.
4. The system shall be able to generate real time updates on the above information when required.
5. The system shall have a function to add/remove personnel from Contractor, LTA and QPS teams to receive notification/alert via mobile devices. Such notifications and alerts shall be made available for monitoring the status for inspection report, incident/accident report, maintenance regime for machinery and equipment as well as for Lifting Equipment and Pressure Vessels.

ELECTRONIC PERMIT-TO-WORK SYSTEM (e-PTW)

1. The e-PTW System shall comply to relevant legislations and contractual specifications. The e-PTW shall be able to be applied, assessed, approved, revoked by user through mobile devices.
2. The information required in (1) shall include but not limited to date, time, requester, reviewer, approver, work location, description, pictures, checkbox for questions and answer (if applicable). Default language of the system must be in English.
3. The information shall be able to be viewed, validated and approved by stipulated deadline.

4. Past records must be kept and maintained for a minimum 5 years from the PTW creation date.
5. Upon request by the Engineer during on-site inspection, the e-PTW documents must be retrievable and available.
6. The e-PTW shall ensure that only the authorized person can approve the permit to work. There must be safeguards to disallow falsification.
7. The creation, submission and approval of the e-PTW must be done on site and the software should have the ability to pinpoint the location of the mobile devices such that approval can only be allowed within the site perimeter and not beyond.
8. The contractor must provide adequate training to users of the e-PTW system. The contractor must ensure that users have a mobile device that can interface with the e-PTW.
9. Users must be able to pre-set workflows to automate processes. These processes including recording observations, acknowledging observations, submitting closure report, verifying report and closing the permit on mobile devices.
10. The e-PTW application must be able to run on all major mobile platform devices such as iOS and Android, including any new software updates to the mobile platform. The web interface of the app must be compatible with commonly available browsers in the market.
11. The e-PTW must be accessible over the internet and be able to function with or without live connection. The date must be synchronized in real time once live connection is established. Users must be able to access the e-PTW from mobile device or web-based interface.
12. Each e-PTW must have its own unique identification number.
13. The e-PTW System shall be developed for high risk work activities, including and not limited to demolition works, piling works, lifting operation, excavation works, works in confined spaces, tunneling work, etc.

14. The e-PTW System shall have the ability to capture data such as text, date, multiple photos per inspection, comment, time stamp of data input or changes and identity of users. It must have an audit trail for investigation purposes.
15. Site drawings, photos and supporting documents should be able to be attached to the e-PTW form and be electronically routed to the authorized person once submission of the form is done and the responsible person shall approve the e-PTW.
16. User must be able to set a deadline for the Permit expiry. The system must trigger automated alerts to relevant supervisors to follow up on cases close to expiry in accordance to pre-set workflow. A copy of the alert shall be sent to LTA and QPS.
17. The e-PTW shall allow the authorized person to revoke the issued permit to work, if the work is unsafe to proceed or poses a risk to the safety, health and welfare of persons at work.
18. The web interface dashboard of the e-PTW system shall be able to show which are the live Permits, which Permits have closed and which are being reviewed.
19. The digital e-PTW should be convertible to PDF format if required, printable and be used as hardcopy reference. The e-PTW data should be downloadable in structured form in MS Excel to aid statistical analysis upon request by the Engineer.
20. The system and meta-data specifications are subjected to Engineer's acceptance. The Contractor shall ensure the system and meta-data specifications can be aligned with other government agency (i.e. HDB, JTC, etc) when required.

TEMPLATES FOR SAFETY DATA IN MS EXCEL FILE

Permit-To-Work (PTW) Data

S/N	Location of Work			Type of works to be performed (ie. Demolition works, excavation works, piling works, lifting operations, works in confined spaces. etc)	Company/ Trade	PTW Serial No.	PTW information			
	Zone Block	Storey	Unit				Permit Start Date/ Time	Permit End Date/ Time	Approved Person	Status (ie. Draft, Submitted, Acknowledged, Assessed, Approved, Rejected, Work Completed, Closed

MetaData**InspectionType + ContractNo + Type of works to be performed OR PTW Serial No.**

Field	Max No. of Characters	Description
Record Type	1	Contains 'D' to denote that this string is a Record Detail
InspectionType	20	Inspection Identifier: e.g. PGI, ECM
PTW		
RecNumber	10	No. of record, Unique running number. To pad zeroes in front if RecNumber is less than 10 characters. Example 0000000009
Location of Work		
Block/Zone	10	Block Zone of the precinct (alphanumeric)
Storey	2	Storey level To pad zeroes in front if storey level is less than ten. Example for storey nine: 09
Unit	4	Unit number To pad zeroes in front if Unit is less than 4 characters. Example 0095
Type of works to be performed	200	Demolition works, excavation works, piling works, lifting operations, works in confined spaces. Etc
Company/Trade	200	Company name (alphanumeric)
PTW Serial No.	200	PTW serial number (alphanumeric)
PTW Information		
Permit Start Date/ Time	15	Format: 0000-CCYY-MM-DD Where 0000 refers to the 24-hour clock notation Example 1300 for 1:00pm
Permit End Date/ Time	15	Format: 0000-CCYY-MM-DD Where 0000 refers to the 24-hour clock notation Example 1300 for 1:00pm

Approved Person	100	Approved person name Spelling/Denoting of names must be consistent throughout their use in the system. For example, if user John Doe is denoted as John in the system. All occurrences of John Doe must be spelt as John and not otherwise. John Doe is therefore not accepted.
Status	200	Draft, Submitted, Acknowledged, Assessed, Approved, Rejected, Work Completed, Closed

INSPECTION / NEAR MISS / INCIDENT / ACCIDENT REPORT

1. A report format shall be built that allows user to record inspection or investigation findings, photographs and close out actions through mobile device.
2. The report shall have the process for submission to authorized personnel for verification and closure of the report.
3. Inspection report shall include hazards classifications to ensure findings are timely close-out. Notification shall be auto generated to alert Contractor, LTA and QPS teams on inspection finding that is not closed out by the specified close-out time. The hazards classification shall be as follows:
 - Priority A – to rectify immediately (same day of inspection)
 - Priority B – to rectify within 3 days
 - Priority C – to rectify within 7 days
4. The report shall be traceable on its status and exportable to MS Excel or PDF when required for generation of safety report or real time updates.
5. The system and meta-data specifications are subjected to Engineer's acceptance. The Contractor shall ensure the system and meta-data specifications can be aligned with other government agency (i.e. HDB, JTC, etc) when required.

TEMPLATES FOR SAFETY DATA IN MS EXCEL FILE**Safety Non-Conformity Report (NCR) Data**

S/N	Location of Work			Name of Initiator	Name of sub-contractors with safety non-compliances	Trade with safety non-compliances	NCR information				
	Zone Block	Storey	Unit				Type of safety non-compliances	Time safety non-compliances found	Time safety non-compliances closed by sub-contractor	Duration taken to close safety non-compliances	Safety non-compliances Severity Level

Observation Reports/Near-Missed Tracking Data (For Negative Site Observation)

S/N	Location of Work			Name of Initiator	Name of sub-contractors with safety non-compliances	Trade with safety non-compliances	Negative Site Observation Information				
	Zone Block	Storey	Unit				Type of safety non-compliances	Time safety non-compliances found	Time safety non-compliances closed by sub-contractor	Duration taken to close safety non-compliances	Safety non-compliances Severity Level

Observation Reports/Near-Missed Tracking Data (For Positive Observation)

S/N	Location of Work			Name of Initiator	Name of sub-contractors with safety compliances	Trade with safety compliances	Positive Site Observation Information
	Zone Block	Storey	Unit				Type of safety compliances

MetaData**Record Identifier:**

Use RecNumber to represent:

InspectionType + ContractNo + Time safety non-compliances found

NCR/ Observation Reports/Near-Missed Tracking (Negative and Positive Site Observation)		
Record Type	1	Contains 'D' to denote that this string is a Record Detail
InspectionType	20	Inspection Identifier: e.g. ECM, Quality or Defect
RecNumber	10	No. of record, Unique running number. To pad zeroes in front if RecNumber is less than 10 characters. Example 0000000009
Name of Initiator	100	Name of initiator Spelling/Denoting of names must be consistent throughout their use in the system.
Name of sub-contractors with safety non-compliances	200	Sub-contractor company name (alphanumeric)
Trade with safety non-compliances	100	Trades inspected
NCR Information		
Type of safety non-compliances	200	Work-At-Height, Hit-By-Falling Objects, Poor Housekeeping, Provisions not in accordance to PE design, struck by Moving Objects, Non-compliances relating to lifting operations and equipment, Non-compliances relating to electrical appliances, poor traffic management, administrative lapses relating to RAs, SWPs or PTWs, inadequate PPEs, collapse of temporary structures, Others
Time safety non-compliances found	15	Format: 0000-CCYY-MM-DD Where 0000 refers to the 24-hour clock notation Example 1300 for 1:00pm

PS-A-318

Time safety non-compliances closed by sub-contractor	15	Format: 0000-CCYY-MM-DD Where 0000 refers to the 24-hour clock notation Example 1300 for 1:00pm
Duration taken to close safety non-compliances	8	Time safety non-compliances closed by sub-contractor minus Time safety non-compliances found (DD-HH-MM)
Safety non-compliances Severity Level	20	Severity – Minor, Major, Critical
Name of sub-contractors with safety compliances	200	Sub-contractor company name (alphanumeric)
Trade with safety compliances	100	Trades inspected
Type of safety compliances	200	Good Work-At-Height provision, Good provision for prevention of Hit-By-Falling Objects, Good Housekeeping, Provisions in accordance to PE design, Good provision for prevention of Struck by Moving Objects, Compliances relating to lifting operations and equipment, Compliances relating to electrical appliances, Good traffic management, Compliances relating to RAs, SWPs or PTWs, Good PPE provision, Good provision to prevent the collapse of temporary structures, Others

RECORD AND MAINTENANCE REGIME OF MACHINERY AND EQUIPMENT

1. All machineries and equipment, including Lifting Equipment (LE) and Pressure Vessel (PV), within the worksites shall be tracked by the system. The details to be monitored and tracked shall include the following:
 - a) Mobilize and demobilize date of the machinery and equipment to and from worksite
 - b) Inspection and expiry dates of LE and PV certificates according to LTA SHE requirements
 - c) Last and next maintenance date for the machinery and equipment
2. The system shall have tracking and reminder function to monitor the status of the machinery and equipment. Notification shall be auto generated to alert the Contractor one month before the expiry/due date for inspection (including statutory inspection for LE and PV) or maintenance, and to LTA and QPS teams whenever the machinery and equipment validity dates are not renewed in the system.

DESIGN FOR SAFETY (DFS) AND DFS PROFESSIONAL

- 1.1 This project falls wholly within the scope of the Workplace Safety and Health (Design for Safety) Regulations, which will be called as DfS Regulations from herein. These DfS Regulations are to be implemented in their entirety irrespective of whether the Contract is awarded prior to the mandatory implementation date (1 August 2016).
- 1.2 The DfS Regulations require all the relevant stakeholders such as Developers, Designers and Contractors to work together to address the risk at source and plan for the construction, maintenance and demolition works in relation to the safety of any person who are:
 - a) Carrying out or affected by the construction work,
 - b) Maintaining the structure, or
 - c) Carrying out or affected by the demolition work
- 1.3 The DfS Regulations emphasize on elimination of all foreseeable risks as far as it is reasonably practicable. Whenever it is not reasonably practicable to eliminate the risks, the risks shall be reduced to as low as reasonably practicable through, but not limited to, reduction of design risk at its source or collective protection measures to be used throughout the lifecycle of a project.

Further information on the DfS Regulations and its guidelines, including the roles and responsibilities of every stakeholder, can be found on the Workplace Safety and Health Council website (<https://www.wshc.sg>).

Contractor shall propose and engage a qualified and competent DfS Professional. The qualifications of DfS Professional proposed for this contract shall include:

- a) Reasonable exposure in safety and health for construction especially on transportation infrastructure projects in a similar nature to this Contract, and
 - b) Attended the DfS for Professional Course and passed the assessment, or equivalent, and either
- Be a registered PE or Architect with a Practicing Certificate or
 - Have 10 years relevant experience in the design (at least five (5) years in design which includes contributions to designs, writing specifications) and the supervision of the construction of structures; and
 - Have a degree accepted by PEB or BOA and construction related degree accepted by SISV and SPM

The final approval for the appointed DfS Professional shall be within the Authority's discretion.

- 1.4 The appointed DfS Professional is to perform the necessary duties as part of the delegation of Authority's duty in convening the DfS Review Meeting and producing DfS Register as stipulated in the DfS Regulations. The duties of DfS Professional also include, but not limited to:

- a) Coordinate the stakeholders (Authority, designers, contractors, etc.) and to facilitate the communication of vital information that could affect safety and health risks in the project
- b) Convene DfS Review Meetings as necessary to identify all foreseeable design risks in the project and discuss how each of the foreseeable design risks can be eliminated or reduced
- c) Ensure that each DfS Review Meetings are attended by all the relevant designers and contractors appointed
- d) Prepare, develop and submit DfS Register containing information and records on every DfS Review Meeting convened and every residual design risk in the project to the Authority
- e) Ensure that the DfS Register is kept up to date
- f) Ensure all designers and contractors appointed for the project have access to the DfS Register

1.5 The DfS Professional shall propose a systematic review process for Authority's approval. For example, to assist the stakeholders in reviewing the design, the **GUIDE** process developed by the Workplace Safety and Health Council in the DfS Guidelines can be implemented:

- a) **G – Group** together a review team consisting of major stakeholders.
- b) **U – Understand** the full design concept by looking at the drawings and calculations, or have the designers elaborate on the design.
- c) **I – Identify** the risks that arise as a result of the design or construction method. The risks should be recorded and analysed to see if they can be eliminated by changing the design.
- d) **D – Design** around the risks identified to eliminate or to mitigate the risks.
- e) **E – Enter** all the information including vital design change information affecting safety and health or remaining risks to be mitigated into the DfS Register.

SAFE WORK PROCEDURE FOR CONTROLLING MOVEMENT OF HEAVY MACHINERY

General

- 1.1 All Heavy Machineries brought into LTA sites are subjected to the Safe Work Procedures for Movement of Heavy Machineries.
- 1.2 This Safe Work Procedure required Contractors to implement three (3) control points prior to moving and using of the heavy machineries on LTA sites:
 - a) Permit to Move
 - b) Permit to Work
 - c) Resuming Work after Heavy Rain
- 1.3 Heavy Equipment refers to any equipment with a high Centre of Gravity (CG), including all Lifting Machineries (LM) such as Boring Rigs, Trench Cutters, Grouting Machines (e.g. Deep Soil Mixing Machines, Wet Soil Mixing Machines), rotary percussion rigs and D-Wall machines.

Item (i) – Permit to Move

- 1.4 This Permit to Move is aimed to monitor and control the movement of large, high mast machines so as to ensure that they are on firm, well prepared ground at all times.
- 1.5 Prior to moving a Heavy Machinery, a Permit to Move is required. Sub-Contractor needs to prepare and submit a Permit to Move to the Contractor. The Permit shall be valid for one (1) rig and only for the location prepared and tested. Each new location shall require a separate permit.
- 1.6 Prior to the approval of the Permit to Move, the following requirements for the location where the heavy machineries are to be moved to shall be satisfied:
 - a) Ground to well compacted using 10T Roller and tested (Plate Bearing Test or calibrated Cone Penetrometer Test)
 - b) Any soft spots to be excavated, replaced with suitable soil, re-compacted and retested.
 - c) Ground then to be topped with compacted hardcore. Minimum 500mm or more if required by PE.
 - d) Steel plates to be laid on top of hardcore.
 - e) All testing to be witnessed by QP(S).
 - f) PE to issue Certificate of Supervision (COS) once works are completed.
 - g) COS should include a signed statement by the supervising PE, design calculations, plan showing area covered by COS, copy of test results, copy of bore logs used for calculations, permissible sequence for rig movements and photos if necessary.
 - h) Area covered by COS to be not greater than 300m².

Relevant documentations need to be attached with the Permit to Move.

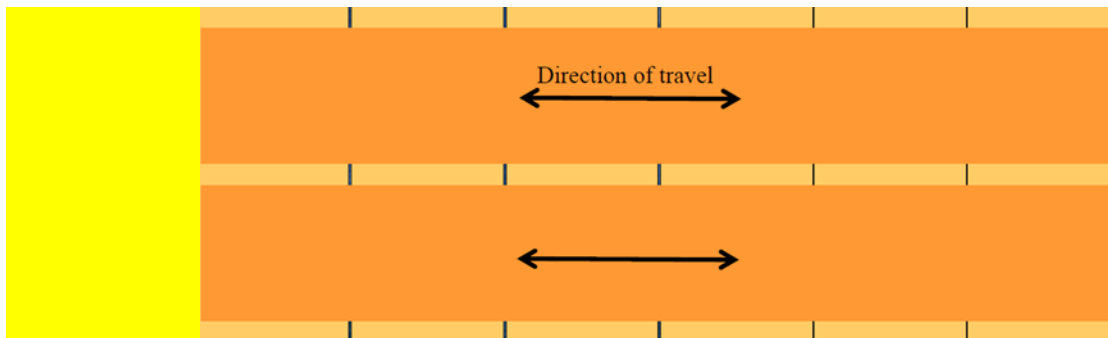

Figure: 2 layers of Steel Plates at right angle to each other

- 1.7 The Permit to Move shall be:
- Prepared, approved and submitted by sub-contractor to Main Contractor;
 - Approved by Main Contractor (recommended three (3) tiers of approval i.e. Lifting Engineer, Authorised WSH Personnel, Project Manager/ Authorised Manager);
 - Acknowledged by QP(S); and
 - Audited by LTA
- 1.8 The PE Design Calculations indicated in Clause 1.6(g) must be comprehensive and should allow for the following as a minimum:
- Static plus dynamic loads;
 - Non uniform distribution of load; and
 - Appropriate allowances for flexing of steel plates.

Item (b) – Permit to Work

- 1.9 Permit to Work and daily checklists are required for daily operations prior to commencing work. The application of the permit shall be accompanied with relevant documentations (i.e. COS by PE, machine daily checklist)
- 1.10 The Permit to Work shall be prepared by Sub-contractor and submitted to Main Contractor for approval. It is recommended to have at least four (4) tiers of approval by Main Contractor (i.e. safety assessor, supervisor-in-charge, authorised WSH personnel project manager/ authorised manager).

Item (c) – Resuming Works After Heavy Rain

- 1.11 After periods of heavy rain, following measures are required:
- Steel plates to be lifted and ground inspected for loss of integrity by Lifting Engineer;
 - Surrounding ground to be also inspected for localised flooding which could reduce the ground's bearing capacity; and
 - QP(S) to witness the inspection and approve prior to resuming the work

If the ground shows loss of integrity then COS shall be void and preparation work must be repeated.

- 1.12 The Lifting Engineer must complete and sign a Crane Access Checklist on a daily basis and after heavy downpour. Following are the examples of items to be checked in the Crane Access Checklist:
- a) Laying of hardcore
 - b) Compaction of Subgrade
 - c) Laying of steel plates
 - d) Dimension in accordance to layout and details
 - e) Proper drainage
 - f) Stability
 - g) Barrier next to ground depression or excavated area
 - h) Others

Other Precautions – Verticality (DSM & Boring rigs only)

- 1.13 Due to the high CG of DSM, WSM machines and boring rigs, manufacturers specify a maximum vertical stability angle for the machine's movement. This angle varies between machines and direction of tilt, and it is typically within the region of 7° . Once this vertical stability angle is exceeded, the machine is prone to collapse.
- 1.14 It is recommended to limit the mast tilt during movement to 5° (i.e. 2° less than lowest limit of vertical stability).
- 1.15 During movement, it is recommended to limit the tilting of the mast to 5° (i.e. 2° less than lowest limit of vertical stability). In addition, the ground to be prepared for the machinery's movement and operation should be as flat as possible.

Formwork Structures

- 1) WSH (Scaffolds) Regulations shall be applicable to the erecting and dismantling of falseworks.
- 2) The Contractor shall not use any mix and match formwork structure on site. This shall include the use of only proprietary access step ladders, working platforms and any other accessories from the same system formwork supplier for erection and dismantling of formwork structure. Strictly no mix and match of any proprietary system formwork components and accessories. The use of any conventional catwalks and monkey ladders for system formwork is not allowed.
- 3) The Contractor's Professional Engineer (PE) responsible for the design and inspection of the formwork structure shall endorse and submit a declaration form attached in this Annex to the Engineer. A flowchart for "Formwork Structure and Concreting" is also attached.
- 4) There shall be at least two Certificate of Supervision (COS) issued by the Contractor's PE. One before rebar installation and one before concreting.
- 5) Notwithstanding Clause 4 above, all wall formwork structure with a height of 4 metres or more shall be designed by a Professional Engineer (PE) and COS issued by the PE before casting of concrete is allowed to proceed.
- 6) The Contractor shall ensure that the height of exposed adjustable base plate or jack base shall be less than 150mm. If the height exceeds 150mm, a longitudinal bracing at a height of not more than 460mm measured from the base plate/support surface shall be provided using right angle or swivel couplers and not more than half the length of the adjustable base plate or jack base is exposed.
- 7) The Contractor shall submit an emergency escape route and emergency response plan before concreting work is allowed to proceed.
- 8) The Contractor's Project Manager (PM) shall endorse and submit a formwork structure checklist attached in this Annex after his inspection of the formwork structure to the Engineer before concreting is allowed to proceed.

Standard Formwork Structure Checklist
TO BE COMPLETED & SUBMITTED PRIOR TO CONCRETING

Reference: _____

Formwork Structure Location: _____

No.	Formwork Safety Issues	Yes /No	Action Required / Remark
1	PE & QPS declaration Forms on formwork structure attached? #		
2	PE certification of lifting points for column boxes and wall shutters? (where applicable) **		
3	Certificate for Safe Use (COS) for formwork structure issued by PE? (Attached to this checklist) **		
4	Contractor's/Formwork Supervisor's Checklist Submitted by Formwork Supervisor prior to laying reinforcement? (Attached to this Checklist) **		
5	Formwork structure built to PE design? Any deviations from endorsed drawings has been designed and certified by PE and further reviewed and agreed by QPS? ##		
6	Risk assessment and safety measures checked by safety officer (Attached to this list) **		
7	Method Statement and risk assessment reviewed and accepted by QPS? (QPS review form to be attached to this checklist) #		
8	Formwork and falsework materials <u>are</u> in good condition and free from corrosion? **##		
9	All modular & system formwork are assembled and erected in accordance with the manufacturer's recommendation? **		
10	All formwork structure system supplied from a single system formwork supplier and no mix and match of different formwork structure system? #		
11	Exposed Adjustable base plate/Jack base <150mm. If exceed, provide longitudinal bracing at height not more than 460mm measured from the base plate/support surface using right angle or swivel couplers and not more than half of the adjustable base plate/Jack base length shall be exposed. **		
12	Seating of formwork structure firm? **		
13	Edges & joints between formwork adequately sealed? #		
14	Proper Access provided using same formwork supplier proprietary step ladders with proper width and with proper riser/thread and proprietary landing/working platforms for erection and inspection of formwork up to the top level? #		

No.	Formwork Safety Issues	Yes /No	Action Required / Remark
15	Edge protection and fall protection provided? **		
16	Openings securely covered? **		
17	Barricades and warning signs provided to prevent access below formwork during concreting? #		

18	Formwork supervisor appointed and qualified? **		
19	Scaffold erectors trained and qualified? **		
20	Formwork watchers appointed? **##		
21	Communication devices provided between Formwork Supervisor and formwork watchers below? **##		
22	Are Emergency Escape Route and Response Plan Available? (Attached to this checklist?) ##		
23	Location plans & photos of inspected structure submitted? (Attached to this checklist) #		
	(other items – to be added as necessary)		

Inspection by: _____ **Contractor's PM** **Signature:** _____ **Date:** _____
Inspection by: _____ **QPS/SRE/RE*/RTO*** **Signature:** _____ **Date:** _____
Acknowledged by: _____ **LTA PM/DPM/SPE/PRAPE*** **Signature:** _____ **Date:** _____

**Only for minor roads projects; QPS/SRE for Complex/Mega/Major Rail Projects or North South Corridor.*

***WSH (Construction) Regulation #Authority Requirement ##SS 580*

PE Declaration Form

Declaration by Professional Engineer Project

Name: _____

Location: _____

I, _____, the Professional Engineer for the formwork structure design, hereby submit the detailed design calculation and drawings prepared by me and certify that, they have been prepared in accordance with provisions of the SS 580:2012, SS EN 1990:2008, SS EN 1992:2008, SS EN 1993:2010, BS EN 12812:2008, Workplace Safety & Health (Construction) Regulations 2007 Part IX Formwork Structures and any written design code pertaining to the design for the time being in force. Not amounting to other consideration, I have taken into account the following aspects:

- Formwork structure shall be capable of sustaining the total dead load, live load and impact loads imposed on the structure with a minimum safety factor of 2;
- Density of fresh concrete with reinforcement shall not be less than 26 kN/m³;
- Total imposed load, not including impact loads, shall not be less than 1.5 kN/m²;
- In no case shall the assumed value of Lateral load due to dumping of concrete, wind, and equipment acting in any direction at each floor line be less than 1.5 kN/m² of floor edge or 2.5% of total load on the form, whichever is greater;
- Lateral pressure of wet concrete on the vertical or sloping formwork as stated in SS580 has been considered;
- Has considered dead load, imposed load, impact load, load on storage areas, horizontal load, wind load and special loads stated in SS580;
- Diagonal bracings to stabilise multiple bays shall be inclined 30° to 60° to the horizontal, and shall be in pairs, with each pair being inclined in the opposite direction to the other, to provide for the change in direction of applied forces.
- There shall be one pair of braces for every 2h vertical support, where 'h' is the height of the covered by the brace, in meters;
- Mix and match formwork system not used;
- The formwork structure has been designed in accordance to the design intent and construction sequence as specified by the QP(Design) for the permanent works;
- Obtain clearance from QP(Design), for the Foundation of formwork structure when permanent works are used to support the formwork structure. Structural calculation showing there is no over stressing and there is no residual stresses in the permanent structure;
- Casting panel for special case e.g cantilever, sloping, big opening, triangle corner; etc;
- The drawings has been prepared in accordance to the Clause 6.2 of SS 580
- Joints and connection details been shown in drawing;

Name, stamp & signature of PE

Date: _____

Flowchart for Formwork Structure & Concreting

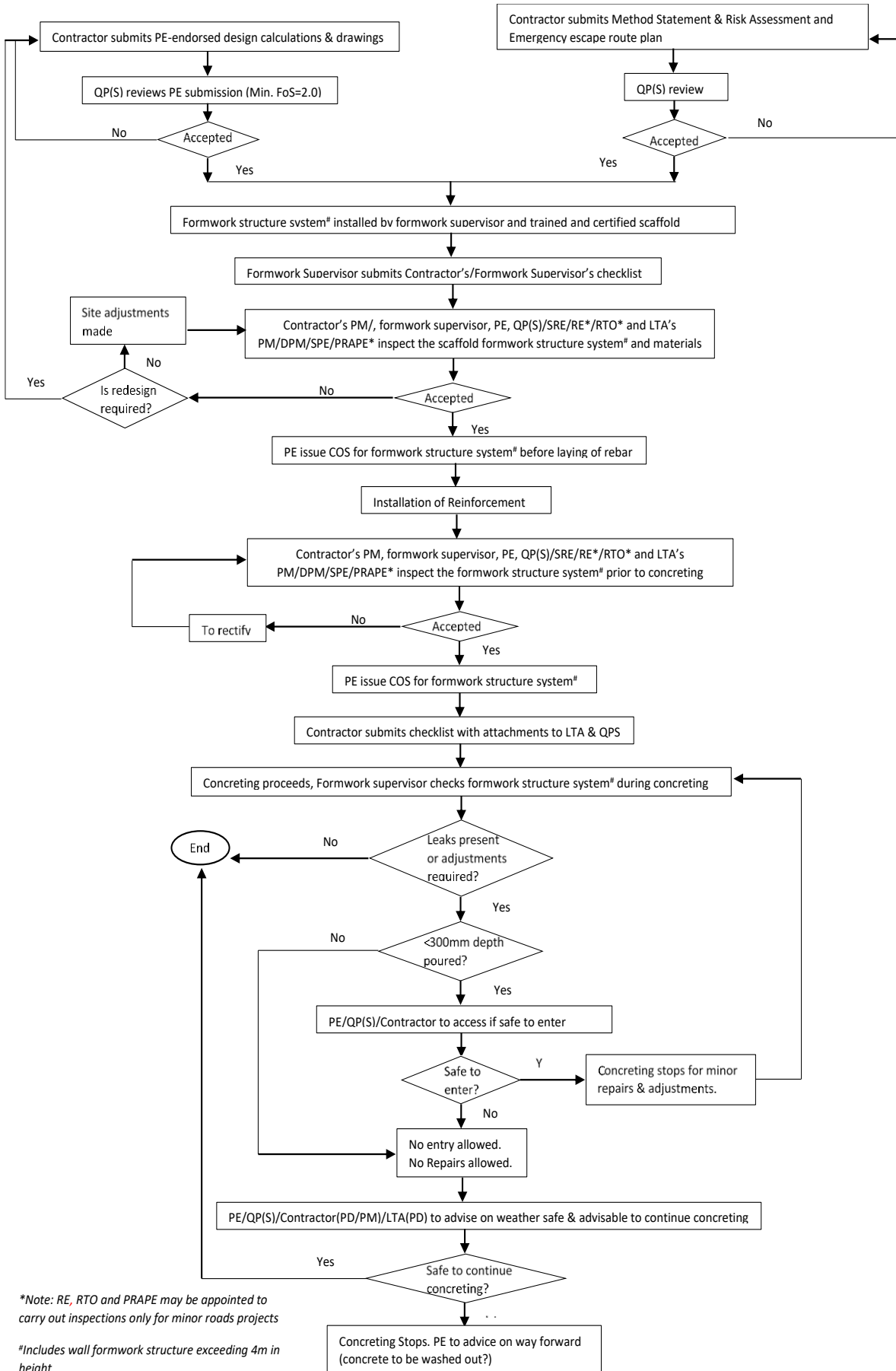

*Note: RE, RTO and PRAPE may be appointed to carry out inspections only for minor roads projects

*Includes wall formwork structure exceeding 4m in height

Safe Management Measures

1. The Contractor shall establish and implement a system of Safe Management Measures (SMM) at worksites to provide a safe working environment and minimise risks of disease outbreaks.
2. The SMM shall include but not limit to the following:
 - a) Segregation of teams and staggered working hours
 - b) Segregate work zone and ensure safe distancing at worksite to reduce physical interaction
 - c) Implement contact tracing protocol
 - d) Check and monitoring workforce's body temperature
 - e) Cohort workers into dedicated teams and accommodations. Measures shall be in place to prevent intermixing of workers from different teams
 - f) Provide point-to-point dedicated transportation for foreign workers from accommodation to worksite and vice-versa
 - g) Regularly sanitised and maintain common shared facilities and equipment
 - h) Develop emergency preparedness plan for suspected cases
 - i) Develop sanitisation & recovery plan for confirmed cases
 - j) Actively monitor unwell employees and guard against incipient outbreak
 - k) Regular inspections shall be carried out at the workplace to ensure compliance at all time. Immediate actions shall be implemented to remedy the non-compliances identified.
 - l) All the records of inspection and corrective action taken shall be kept and made available upon request by Authorities
3. Dedicated personnel (e.g. Safe Management Officers, Safe Distancing Officers) shall be appointed to coordinate and implementation of SMM.
4. Contractor shall conduct yearly table-top exercise to familiarise as well as to test the effectiveness of the SMM plan.

Construction Site Machinery Key Management Procedure

Purpose

1. The purpose of this procedure is to protect the life of workers and prevent damage to properties as well security of machinery on site. It sets up a proper key control process to ensure only trained and authorised operators have access to these keys and prevent withdrawal of keys by untrained operators.
2. It shall serve as a framework by which all machinery keys and access credentials will be managed, issued, duplicated, stored, controlled, returned, replaced, and accounted for by the **Key Control Authority (“KCA”)**.
 - a) The KCA can be an appointed person (eg. Construction Manager/WSHO), department (eg. WSH Department), or committee (eg. WSH Committee) that has authority to adopt, administer, and enforce the worksite’s Key Management Procedure.
 - b) The **Key Issuer/s** shall be the personnel in-charge of the assigned work zone/s, eg. Site Manager/Engineer in charge of the respective work zone.
 - c) This procedure shall apply to all construction machinery keys including equipment, vehicles, crane limit switches padlocks controlled by the contractor.

Principles of Usage

1. All machinery keys referred to in this procedure shall not be altered or duplicated.
2. A key will only be issued to individual/s with legitimate and official reasons; re-authorization is required for individuals requesting a replacement key.
3. The individual to whom the key is issued is ultimately responsible for the proper use, care and safeguarding (e.g. do not store key in unlocked desk drawers or other unsecured areas.)
4. Individuals entering locked machinery are responsible for re-securing all doors and that the machinery is powered down when not in use.
5. Key must not be used to grant access to non-authorized individuals.
6. Lost or stolen key must be reported to the Key Issuer. Key that is no longer required must be returned to Key Issuer immediately.
7. Individuals shall not pry open machinery doors for entry.
8. An individual will be revoked from withdrawing / holding the key if he/she has two separate incidents of lost, missing, stolen, damaged or non-returned key violations within a one-year period. The individual shall also be penalised.

Procedure

1. The person requesting for the key shall submit relevant documents (eg. competency training certificate, letter of appointment from company, work permit, relevant machinery operator license if any, Singapore driving license equivalent to the class of machinery the operator will be handling) to the KCA for approval.
2. After approval is granted, the KCA shall update the machinery register with the authorized operators list (with photo). The register shall be kept at the designated control point(s).
3. All authorized operators shall be briefed by the KCA on the Key Management Procedure.

Note: Key Management Procedure shall be attached to appointment letter of machinery operators.

4. The Key Issuer at designated control point(s) will verify the authorized operators' listing and photo before issuing key.

*Note: A centralized **Key Control Safe/Cabinet** shall be available and kept locked at each designated control point that will be under the control of the Key Issuer.*

5. The Key Issuer shall brief the operator again on 3 important rules before issuing key:
 - a) Do not leave the key unattended in the ignition point.
 - b) Do not hand over the key to others.
 - c) Report immediately to KCA if the key is lost/ damaged.

6. The authorized operator will acknowledge and fill up the **Machinery Key Logbook** to sign-out the key(s).

7. The authorized operator will return the key(s) at end of work shift to the Key Issuer and sign-in on the **Machinery Key Logbook**.



*Note : **Reminder tag** shall be provided on the key as well as at strategic location of the machinery to remind the operator to **"Remove key when not in use"**.*

8. If any authorized operator is found in violation of this procedure, key access shall be revoked and a penalty shall be imposed by the company.

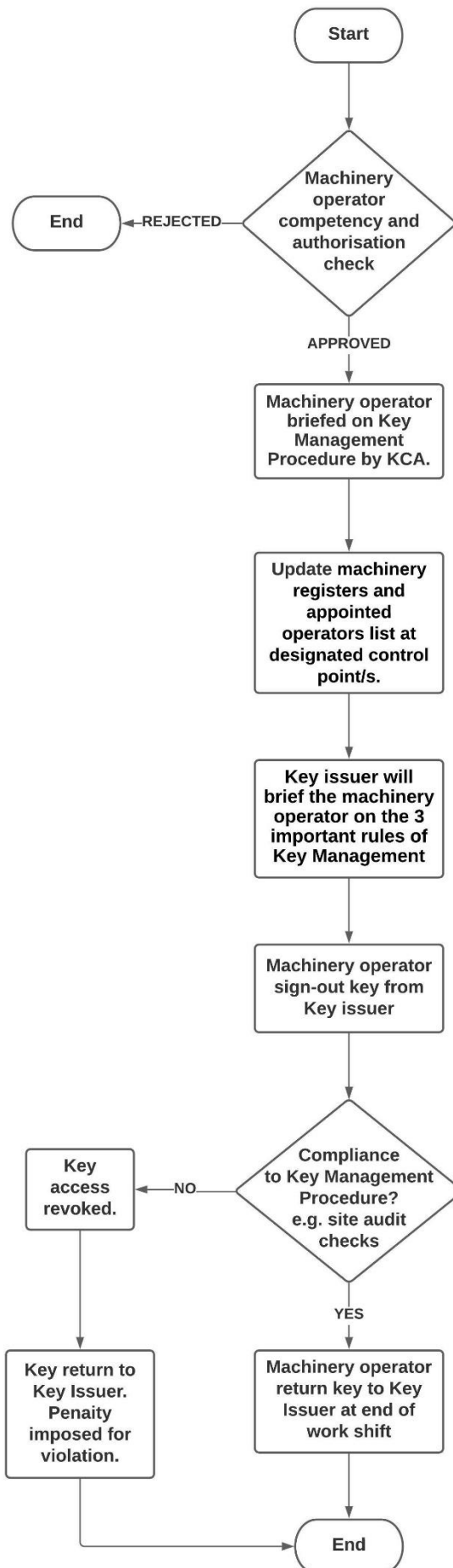
CONSTRUCTION SITE MACHINERY
KEY MANAGEMENT PROCEDURE FLOWCHART

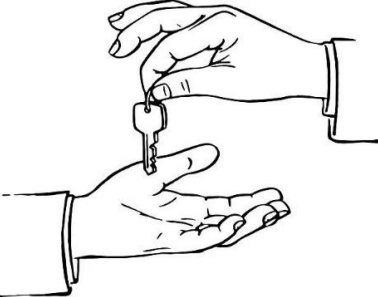

**CONSTRUCTION SITE MACHINERY
KEY MANAGEMENT PROCEDURE ROLES AND RESPONSIBILITIES**

Key Control Authority (KCA)	Key Issuer	Machinery Operator
		
<ol style="list-style-type: none"> 1. Review competency of machinery operator before issuing authorisation. 2. Update machinery register and authorized operators list (with photo) at designated control point(s). 3. Carry out enforcement for compliance of Key Management Procedure on-site (eg. site audit checks, issue penalty, revoke key access, issue stop work) 	<ol style="list-style-type: none"> 1. Ensure key is issued only to authorized operator. 2. To brief the authorized operator on 3 important rules before issuing key. 3. Ensure all machinery keys are returned at end of work shift or when work has stopped. 4. Lock the Key Control Safe/Cabinet when not in use. 	<ol style="list-style-type: none"> 1. Fill up the Machinery Key Logbook to sign-out the key(s). 2. Observe 3 important rules: <ol style="list-style-type: none"> a) Do not leave the key unattended in the ignition point. b) Do not hand over the key to others. c) Report immediately to KCA if the key is lost/damaged. 3. Return the key at end of work shift to the key issuer and sign-in on the Machinery Key Logbook. 4. Comply with the Key Management Procedure.