



Construction Safety Handbook



Land Transport
Authority 
We Keep Your World *Moving*



PERSONAL INFORMATION

All reasonably practicable steps in accordance to safe and sound practices must be taken to ensure workplace health, safety and welfare of all personnel during every phase of construction.

Name: _____

Designation: _____

Company: _____

Contact No: _____



All rights reserved. This publication is not for commercial purposes. It is intended for the use of the Land Transport Authority's officers and its Contractors. No part of this publication may be reproduced or transmitted in any form or by any means, in part or whole, without the prior written permission of the Land Transport Authority.

Copyright © September 2012

Land Transport Authority, Singapore

Published by Land Transport Authority

Enquires can be directed to LTA Safety Division



SAFETY AND HEALTH POLICY STATEMENT

The Land Transport Authority's mission is to provide an efficient and cost-effective land transport system for Singapore. In discharging our responsibilities, we accord paramount importance to safety and health.

OUR GOAL

We strive for the highest standards of safety and health consistent with international best practices. We strongly believe that every accident is avoidable. We aim to achieve zero incidents for all our projects and zero health impact to our workforce.

OUR COMMITMENTS

We pledge to:

- place top priority on the safety of all users of road, rail and public transport systems;
- make safety and health a primary objective in the planning, design, construction, operation, maintenance and regulation of land transport infrastructure and systems; and
- continually achieve improvement in the overall safety and health performance of our projects towards zero incidents and zero health impact to our workforce.

OUR STRATEGIES

We pursue excellence in safety through:

- implementing a structured Project Safety Review (PSR) system in the planning, design, development and management of land transport infrastructure and systems;
- complying with statutory requirements and implementing an occupational safety and health (OSH) management system in the construction of land transport infrastructure and systems;
- nurturing a corporate culture that promotes safety and health;
- collaborating with our contractors and relevant institutions to enhance safety and health.

OUR ROLES

"Safety and Health for All" must be embraced by everyone. All staff who have direct control of activities that affect safety and health are to demonstrate them explicitly in their execution of these activities.



CONTENTS

Introduction	1
Construction Safety Indicators	3
Risk Management	5
Behavioural Based Safety (BBS)	13
Confined Space	17
Electrical Installations	33
Excavations	43
Fire Safety	55
First Aid	67
Hazardous Substances	71
Housekeeping	77
Ladders	89
Lifting Operations	93
Lockout Procedure	121
Machinery Guarding	127
Scaffolding	133
Tunnelling	149
Working At Height	157
Works Train Operation	163
Personal Protective Equipment	173
References	183



The Land Transport Authority published its first Construction Safety Handbook in October 2002. Since then, the Workplace Safety and Health (WSH) Act and its subsidiaries regulations had been gazetted, replacing the Factories Act. The regulations that follow the Act emphasize the importance of proactive management of WSH.

The 3 principles of the new framework for management of WSH are :

- a) reducing risk at source;
- b) instilling greater industry ownership of WSH outcome; and
- c) preventing accidents through higher penalties for poor WSH management.



Some of the subsidiary regulations of WSH Act which are applicable to the construction industry are as follows :

- WSH (General Provisions) (Amendments) Regulations 2011
- WSH (Construction) Regulations 2007
- WSH (Incident Reporting) Regulations 2006
- WSH (First Aid) (Amendment) Regulations 2011
- WSH (Medical Examinations) Regulations 2011
- WSH (Risk Management) Regulations 2006
- WSH (Explosives Powered Tools) Regulations 2009
- WSH (Confined Spaces) Regulations 2009
- WSH (Operations of Cranes) Regulations 2011
- WSH (Scaffold) Regulations 2011

This revised Construction Safety Handbook aims to provide project teams, contractors and consultants a better understanding and emphasis of the updated WSH regulations, LTA's Safety & Health requirements and encourage safe work practices in construction sites.

**A positive WSH
culture starts with you**



Accident Frequency Rate (AFR) :

$$\frac{\text{No of MOM Reportable Accident}}{\text{Manhours Worked}} \times 1,000,000$$

Accident Severity Rate (ASR) :

$$\frac{\text{No of Mandays lost due to MOM Reportable Accident}}{\text{Manhours Worked}} \times 1,000,000$$

This page is intended to be left blank.



**Risk
Management**



WSH (Risk Management) Reg. 4 :

The employer, self-employed person and principal shall take all reasonably practicable steps to eliminate any foreseeable risk to any person who may be affected by his undertaking in the workplace.

Where it is not reasonably practicable to eliminate the risk, the employer, self-employed person or principal shall implement :

- a) such reasonably practicable measures to minimise the risk; and
- b) such safe work procedures to control the risk.

The measures may include all or any of the following :

- a) substitution;
- b) engineering Control;
- c) administrative Control;
- d) provision and use of suitable personal protective equipment.

Note: Elimination of hazards should take first priority while use of PPE should be the last line of defence.



HIERARCHY OF RISK CONTROL

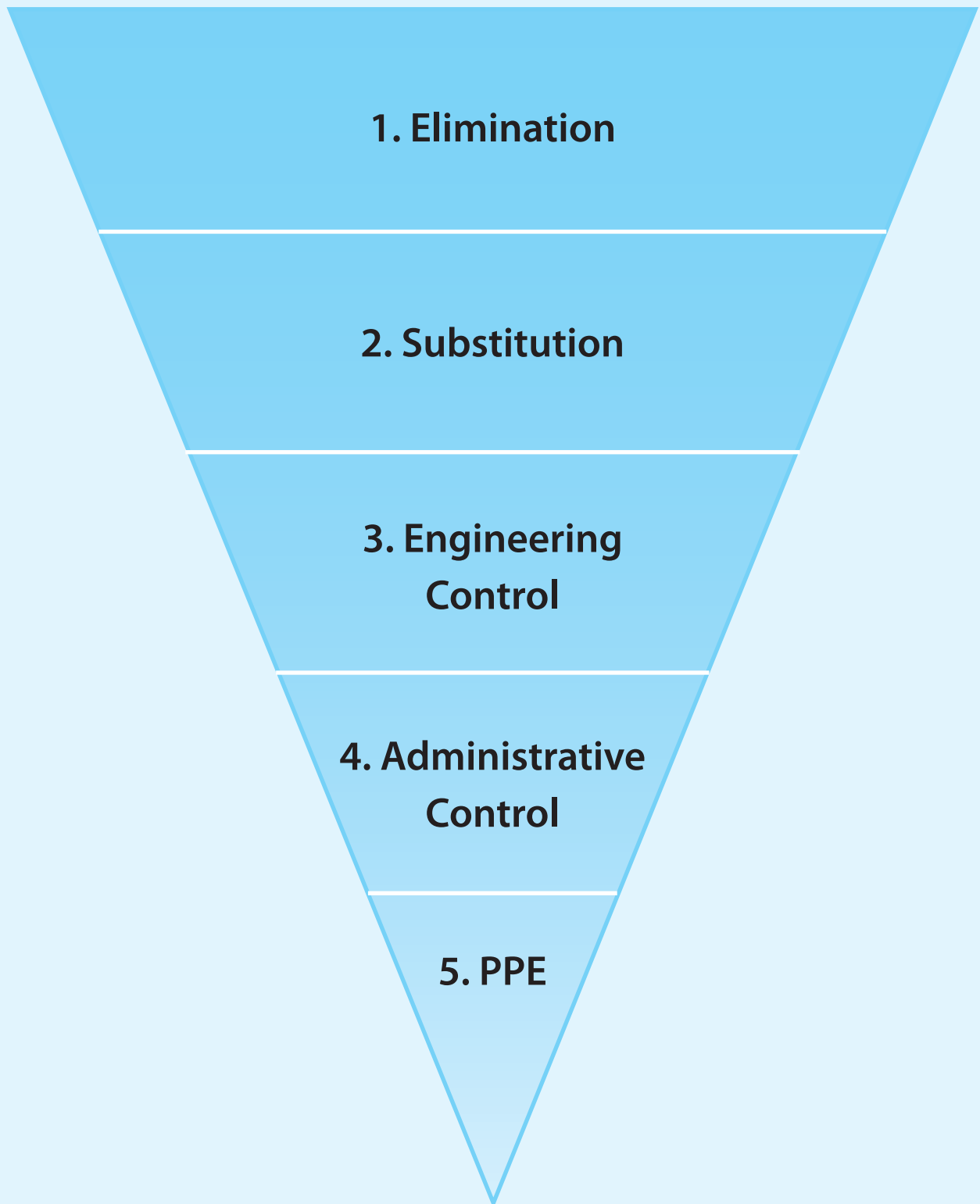



Step 3: Risk Control

- Formulate control measures according to the Hierarchy of Controls
- Analyse and evaluate residual risks

Step 2: Risk Evaluation

- Evaluate the risk levels of the workplace hazards
- Prioritise the hazards to be controlled

Step 1: Hazard Identification

- Identify hazards
- Identify potential accidents or incidents



WSH (Risk Management) Reg. 2 :

A 'hazard' means anything with the potential to cause bodily injury, and includes any physical, chemical, biological, mechanical, electrical or ergonomic hazard.

A 'risk' means the likelihood that a hazard will cause a specific bodily injury to any person.

LTA General Specification :

The Contractor shall identify all safety critical activities using the risk matrix (please refer to next 2 pages) and ensure that a method statement is prepared for each activity and accepted by the Engineer before commencement of such activities.

Likelihood	Rating	Description
Frequent	I	Likely to occur 12 times or more per year
Probable	II	Likely to occur 4 times per year
Occasional	III	Likely to occur once a year
Remote	IV	Likely to occur once in 5 year project period
Improbable	V	Unlikely, but may exceptionally occur

Accident Frequency (LTA General Specification)



Consequences	Rating	Description
Catastrophic	I	<ul style="list-style-type: none">• Single or Multiple loss of life from injury or occupational disease, immediately or delayed; and/ or• Loss of whole production for greater than 3 days and/ or• Total loss in excess of \$1 million
Critical	II	<ul style="list-style-type: none">• Reportable major injury¹, occupational disease¹ or dangerous occurrence; and/ or• Damaged to works or plants causing delays of up to 3 days; and/ or• Total loss in excess of \$250,000 but up to \$1 million
Marginal	III	<ul style="list-style-type: none">• Reportable injury², occupational disease²; and/ or• Damage to works or plants causing delays of up to 1 day; and/ or,• Total loss in excess of \$25,000 but up to \$250,000
Negligible	IV	<ul style="list-style-type: none">• Minor injury³, no lost time or person involved returns to work during the shift after treatment; and/ or• Damage to works or plants does not cause significant delays; and/ or• Total loss of up to \$25,000

Note: () If more than one of the descriptions occurs, the severity rating would be increased to the next higher level. Applicable to item numbers 2 and 3 only.*

¹ For man-days lost greater than 7 days

² For man-days lost greater than 4 to 7 days

³ For man-days lost greater than 1 to 3 days

Accident Severity (LTA General Specification)



Risk Category			Accident Severity Category			
			I	II	III	IV
			Catastrophic	Critical	Marginal	Negligible
Accident Frequency Category	I	Frequent	A	A	A	B
	II	Probable	A	A	B	C
	III	Occasional	A	B	C	C
	IV	Remote	B	C	C	D
	V	Improbable	C	C	D	D

Risk Index Matrix (LTA General Specification)

Risk Index	Description	Definition
A	Intolerable	Risk shall be reduced by whatever means possible.
B	Undesirable	Risk shall only be accepted if further risk reduction is not practicable.
C	Tolerable	Risk shall be accepted subject to demonstration that the level of risk is as low as reasonably practicable.
D	Acceptable	Risk is acceptable.

Definition of Risk Index (LTA General Specification)



RISK MANAGEMENT

ACTIVITY-BASED RISK ASSESSMENT FORM												
Company :			Activity/Process :			Location of work :						
Conducted By (RA team members) :	Name	Designation	Date	Reviewed By :	Name	Designation	Date	Approved By :	Name	Designation	Date	
Last Review Date :				Next Review Date :								
S/No	Description of Work Activity	Hazards Identified	Risk	Existing Control Measures	Initial Risk Index			Additional Control Measures	Residual Risk Index			
					F	S	R		F	S	R	
								Risk Owner (Action Officer)		Follow-up Period		
								Name		Designation		

F : Frequency (I= Frequent, II= Probable, III=Occasional, IV=Remote, V=Improbable)

S : Severity (I=Catastrophic, II=Critical, III=Marginal, IV=Negligible)

R : Risk Index (A=Intolerable, B=Undesirable, C=Tolerable, D=Acceptable)

Safety and Health Hazard Log (LTA General Specification)

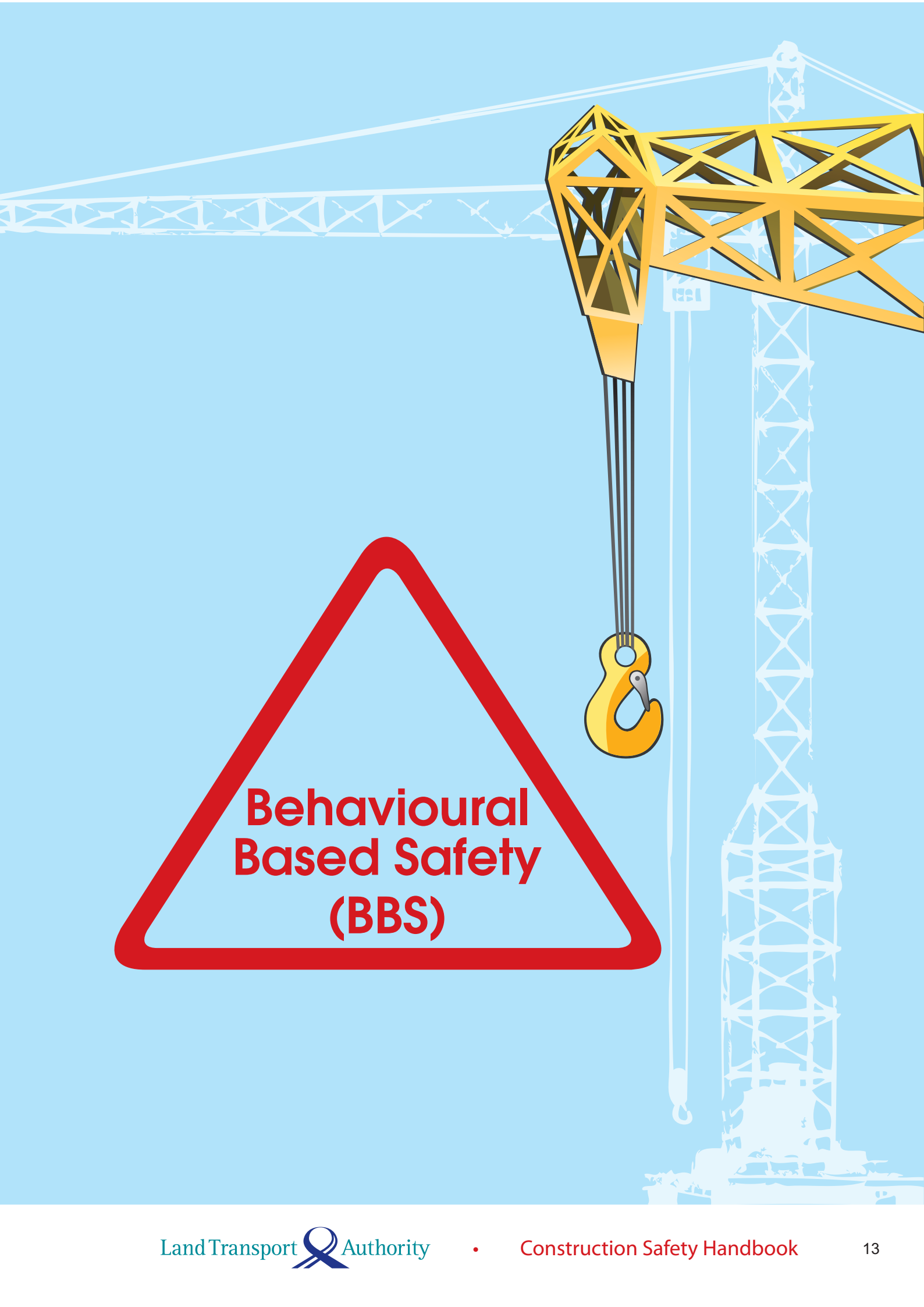

**Behavioural
Based Safety
(BBS)**



LTA General Specification :

The Contractor shall implement a BBS programme based on the training provided by the Engineer. The BBS programme shall be approved by the Engineer before implementation.

The BBS programme shall include :

- a) conducting a Safety Culture Survey through questionnaires. The Contractor shall ensure that the Safety Culture Survey is conducted effectively and interpreters shall be appointed if necessary;
- b) training of management staff, site supervisory staff, workers and the appointed observers;
- c) assigning Observers to conduct observations of safe and unsafe behaviours. The Observers appointed shall base on the ratio of 1 Observer to 50 workers. Each Observer shall conduct regular observations of at least twice a week, and each duration shall be about 20 minutes each;
- d) direct Observers to input observations into the Engineer's BBS Database System for monitoring and analysis;
- e) organise goal setting committees chaired by senior site management and introduce intervention strategies to correct the unsafe behaviours for continual improvement.



BBS is a proactive safety approach focusing on motivating individuals to work safely and correct fellow workers' at-risk behaviours that may lead to an injury. Its ultimate aim is to condition the target group's way of thinking and reinforcing positive safety beliefs, values and attitude which will then influence their behaviour and building a good safety culture.

BBS starts with baseline observation where workers behaviours were observed without any intervention based on an established checklist of critical behaviours.

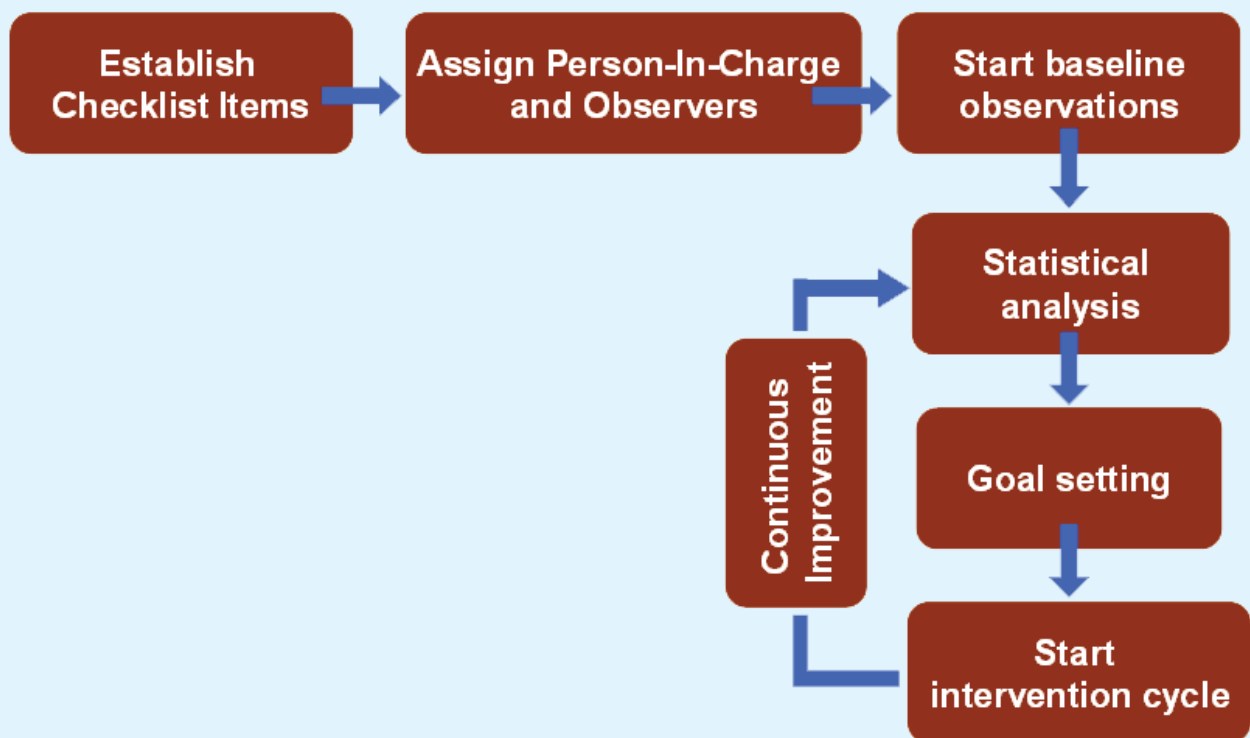

BBS Implementation Procedure



Based on the result of baseline observation, a goal-setting committee was formed to set achievable targets for safe behaviour improvement for the critical behaviours and monitor intervention results according to the intervention cycle below.

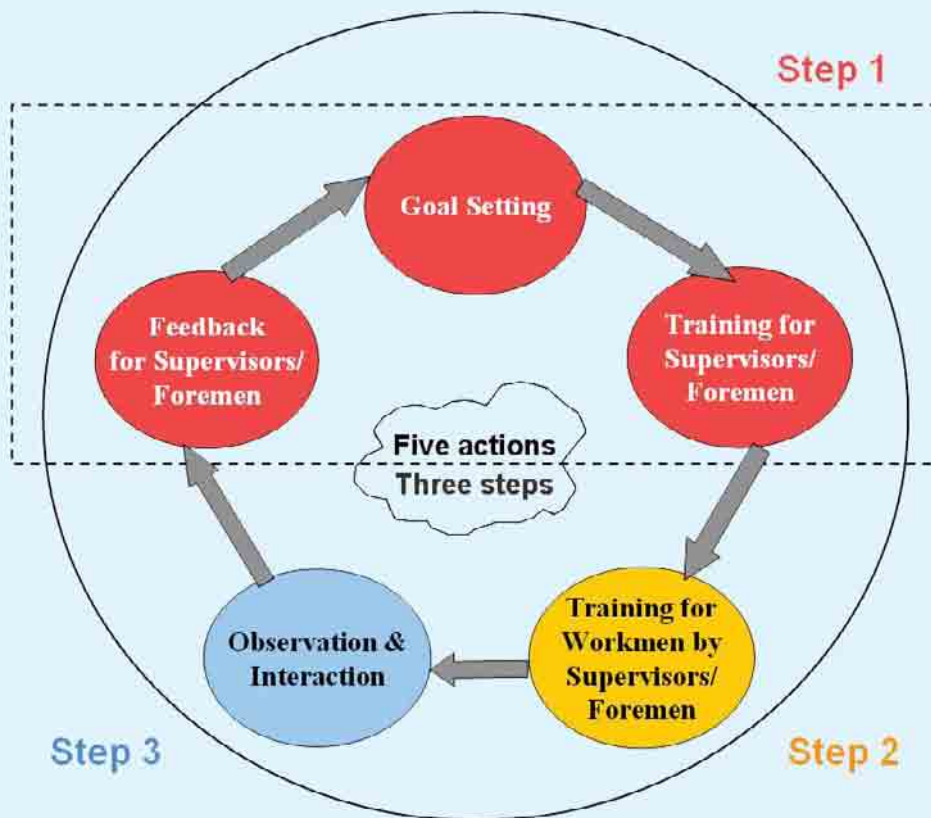

BBS Intervention Cycle

Step 1 :

Observation results and causes of unsafe behaviours communicated to supervisors

Step 2 :

Train the trainers (supervisors) on methods to promote safe behaviour

Step 3 :

Discuss and set new goals for next observation cycle

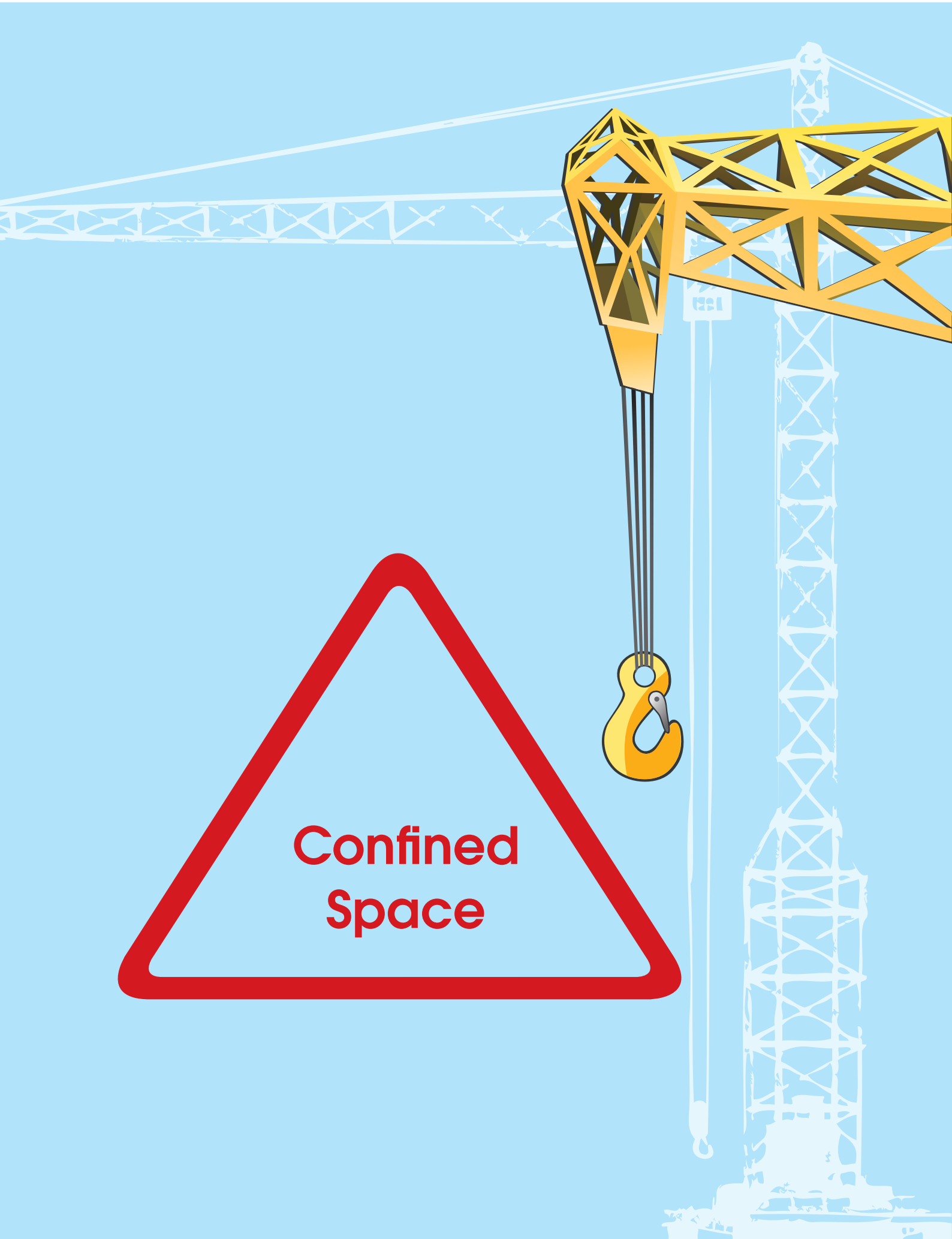

**Confined
Space**



CONFINED SPACE

WSH (Confined Spaces) Reg. 4 :

Where a fixed and stationary confined space is sited in a factory, it shall be the duty of the occupier of the factory to:

- a) make a record of the description and location of the confined space; and
- b) inform persons who are liable to be exposed to the hazards of the confined space, of the existence and hazards of the confined space.



Warning signage to inform workers before entering into confined space





WSH (Confined Spaces) Reg. 13 :

The authorised manager for a confined space may issue a confined space entry permit in respect of entry into or work in the confined space if the authorised manager is satisfied that:

- a) the level of oxygen in the confined space is within the range of 19.5% to 23.5% by volume;
- b) the level of flammable gas or vapour in the confined space is less than 10% of its lower explosive limit;
- c) the levels of toxic substances in the atmosphere of the confined space do not exceed the permissible exposure levels as specified in the First Schedule to the Workplace Safety and Health (General Provisions) Regulations;
- d) the confined space is adequately ventilated;
- e) effective steps have been taken to prevent any ingress of dangerous gases, vapours or any other dangerous substances into the confined space; and
- f) all reasonably practicable measures have been taken to ensure the safety and health of persons who will be entering or working in the confined space.



CONFINED SPACE



Real-time Gas Monitoring System



Permit-To-Work displayed on site



Provision of ventilation fan and duct



SS 510: 2005 :

Confined space with little natural ventilation and no easy means of escape for personnel; where there may be danger

a) from :

- (i) excessive concentration of certain gases, such as oxygen, that supports combustion;
- (ii) the accumulation of flammable or explosive air-gas mixtures;
- (iii) gases harmful to health; or

b) from a combination of such gases; or

c) from deficiency of oxygen

the space shall be purged of all flammable or toxic liquids, gas vapours, or dust before any welding or cutting is done and before any man enters a confined space. Suitable tests shall be performed by competent persons to ensure that no such hazardous substances are present and that the oxygen content of the space is adequate but not excessive.



CONFINED SPACE

SS 568: 2011:

The confined space safety assessor shall conduct the test in the following sequence unless all are conducted simultaneously:

- a) level of oxygen content;
- b) level of flammable gas or vapour;
- c) concentration of toxic gas or vapour.



Confined space ventilation



Source of free air is obstructed



LTA General Specification:

Gas monitoring shall be conducted by a competent confined space assessor to certify that the confined space is safe for workers to enter and thereafter at every **four**-hour intervals.

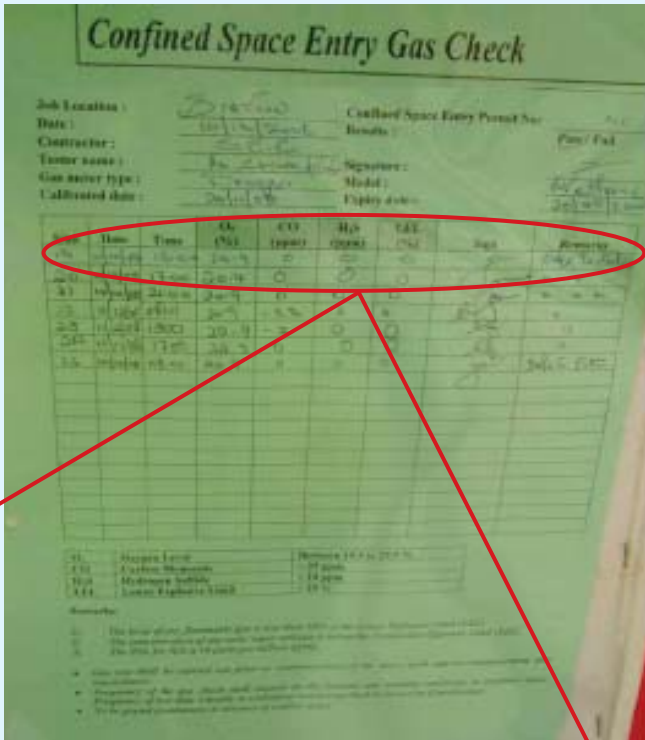

Date	Time	O ₂ (%)	CO (ppm)	H ₂ S (ppm)	LEL (%)	Sign	Remarks
2018/08/24	08:00	20.5	0	0	0	[Signature]	Safe to enter
2018/08/24	12:00	20.5	0	0	0	[Signature]	Safe to enter
2018/08/24	16:00	20.5	0	0	0	[Signature]	Safe to enter



Display of gas check



WSH (Confined Spaces) Reg. 21:

It shall be the duty of the responsible person of a person entering into or working in a confined space to ensure, before such entry or work, that the person has first received adequate safety and health training for the purpose of familiarising himself with the hazards associated with such entry into or work in the confined space and the precautions to be observed.

Following courses are recommended for Confined Space works :

- *Safety Orientation Course (Manhole) for Workers*
- *Safety Instruction Course (Manhole) for Supervisors*
- *Confined Space Safety Assessor Course*
- *Manhole Safety Assessor Course*
- *Occupational First Aid Course*
- *Confined Space Entry and Rescue Course*



WSH (Confined Spaces) Reg. 22:

An appointed confined space attendant shall remain outside the confined space in order to :

- a) monitor persons entering into and working in the confined space;
- b) maintain regular contact with the persons in the confined space and when necessary assist them to evacuate should the need arise; and
- c) alert the persons appointed to carry out rescue work in the event of an emergency.



Confined space attendant maintaining regular contact with worker inside confined space



CONFINED SPACE

WSH (Confined Spaces) Reg. 23:

It shall be the duty of the responsible person of a person entering into or working in a confined space to establish a written rescue plan for the purpose of rescuing persons in the confined space in the event of an emergency.

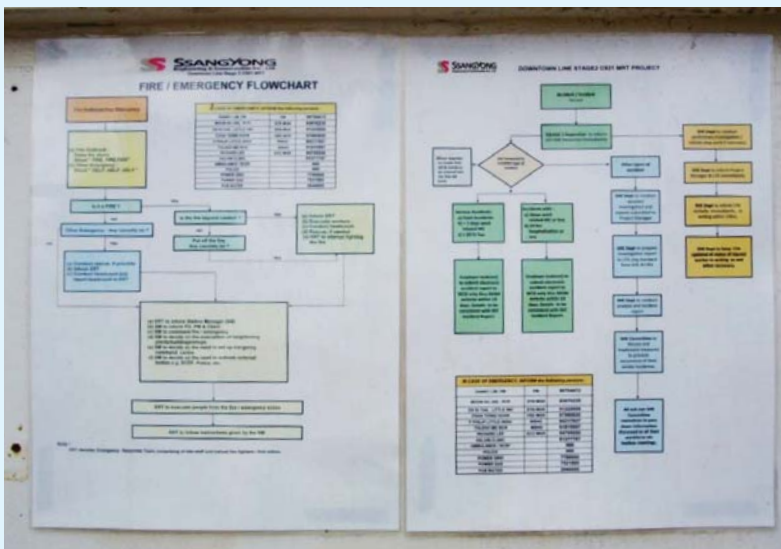

Emergency flowchart prominently displayed on site



Emergency Escape Route and Assembly Area signs prominently displayed on site



WSH (Confined Spaces) Reg. 25:

No person shall enter or remain, and no person shall require, instruct or direct any person to enter or remain, in the confined space for any purpose unless the person entering or remaining in the confined space:

- a) is wearing a suitable breathing apparatus;
- b) has been authorised to enter by a competent person; and
- c) when reasonably practicable, is wearing a safety harness with a rope securely attached and there is a person keeping watch outside who is provided with the means to pull him out in an emergency.



Use of suitable breathing apparatus in confined space



CONFINED SPACE

SS 568: 2011:

Forced ventilation:

The air supply shall be from a source free from contamination.

Exhaust ventilation:

Exhaust air from the ventilation system shall be exhausted to a location outside the confined space.



Confined space ventilation

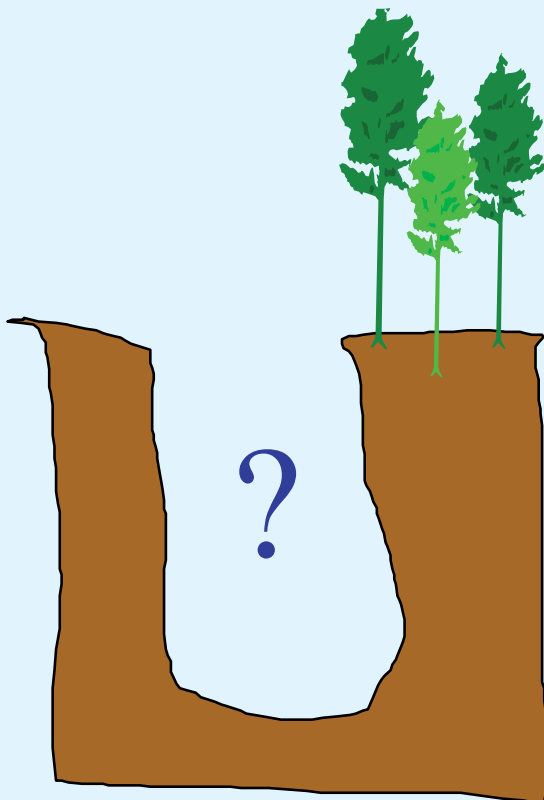

LTA General Specification:

In addition to the requirements of the WSH (Confined Spaces) Regulations and SS568:2011 (Code of Practice for Confined Spaces), the contractor shall also classify manholes, enclosed formwork, culvert drains, excavations more than 4 meters deep, partially enclosed excavations and tunnels as confined spaces and apply all legislative requirements of confined spaces.



LTA General Specification:

The Contractor shall ensure that there is an certified man-riding cage capable of taking a stretcher and two persons, together with an identified crane equipped with rescue equipment, on standby at all times whilst work is carried out in the confined space.

Where this is not reasonably practicable a stretcher which is capable of being brought manually out of the confined space should be located at a convenient point.



Example of man-riding cage which is capable of taking a stretcher and two persons together



CONFINED SPACE

LTA General Specification:

The Contractor shall have controlled access/ egress points to confined spaces to prevent unauthorised access. Where practicable, the Contractor shall ensure that there are at least **two** readily accessible escape routes from each confined space.



Two escape routes from the excavation area



SS 568: 2011:

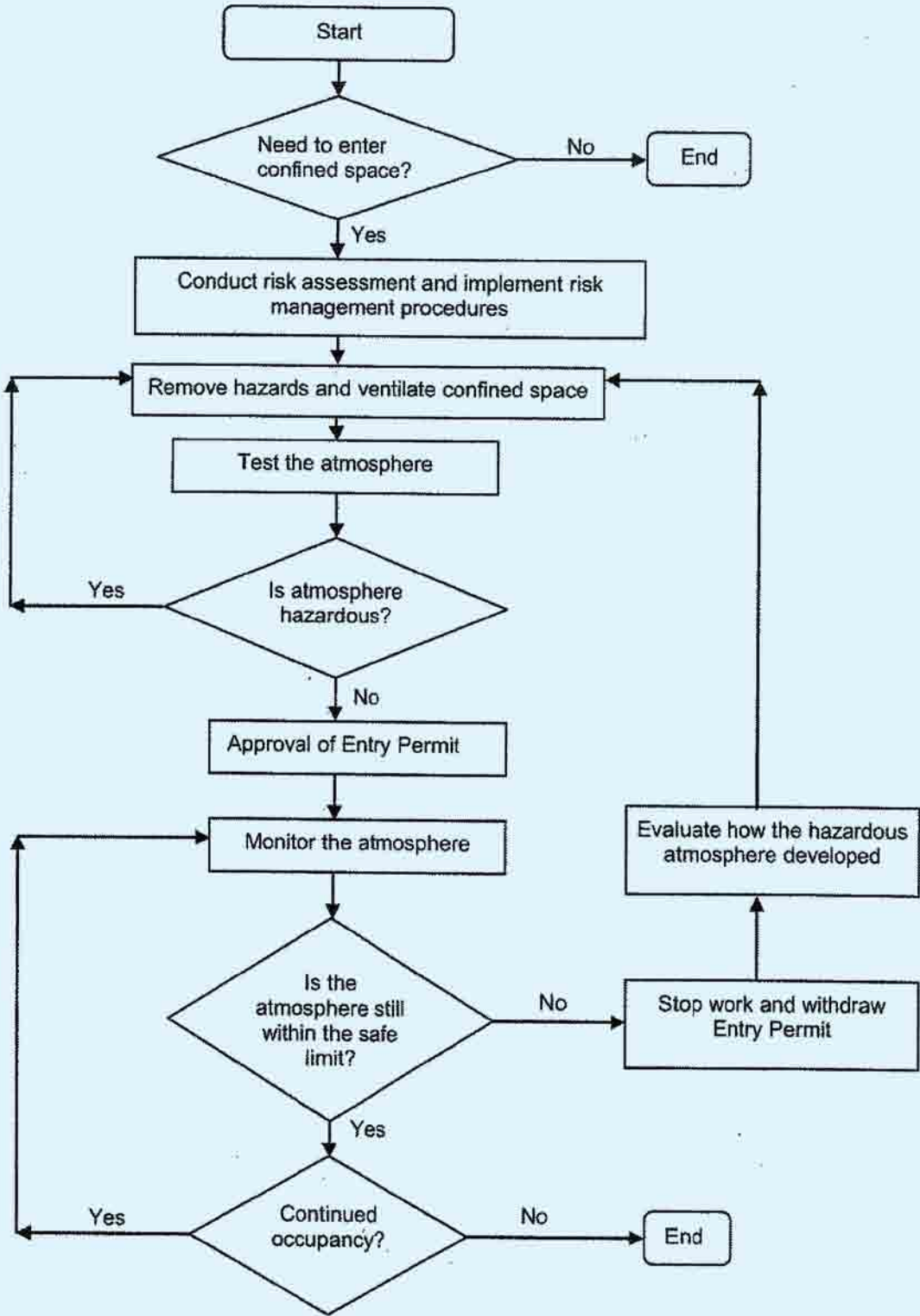

Flowchart of procedures for confined space entry

This page is intended to be left blank.

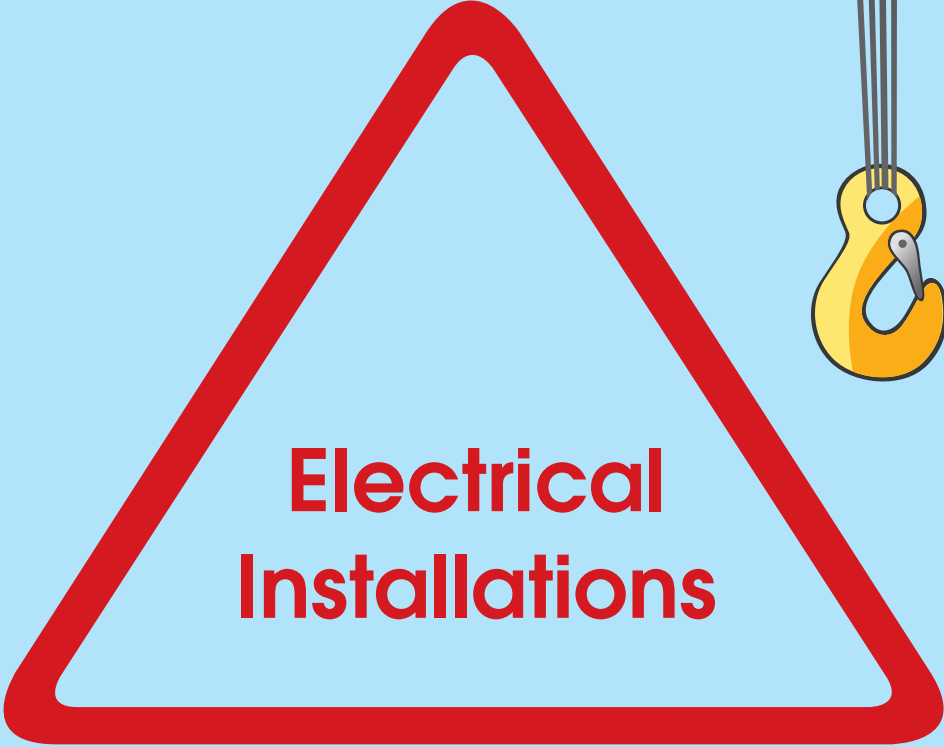
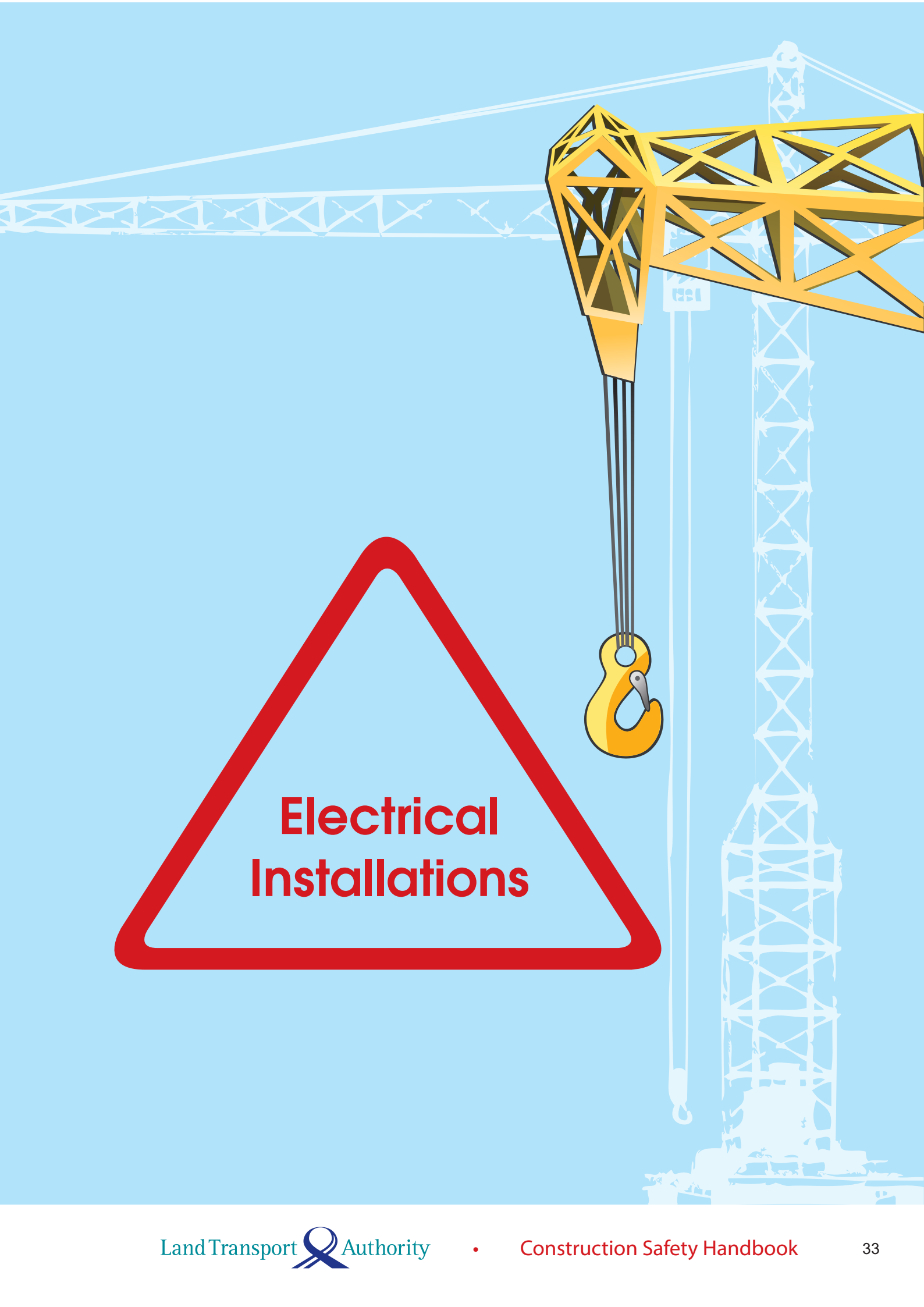



WSH (Construction) Reg. 35:

All electrical wiring in a worksite shall:

- a) be supported on proper insulators; and
- b) not be looped over nails or brackets.



Hang cables on proper insulator, not left on wet ground

WSH (Construction) Reg. 35 :

No electrical wiring or cable shall be left or laid on the ground or the floor of a worksite unless it is :

- a) of the weather-proof type;
- b) provided with adequate protection to withstand the wear and tear to which it may be subjected; and
- c) maintained in good and safe working order.



Cables left lying on ground



Electrical wiring are not maintained in a safe working environment



WSH (Construction) Reg. 37:

It shall be the duty of the occupier of the worksite where any electrical installation is used in the worksite to ensure that:

- a) effective residual current circuit breakers are installed for all temporary electrical installations to provide earth leakage protection; and
- b) overcurrent protective devices with the appropriate ratings are installed in the distribution board to provide overcurrent or short-circuit protection.



Distribution board with Residual Current Circuit Breaker (RCCB) and other safety devices



CP 88: Part 1: 2001:

All cables are to be installed without obstructing the passageways, walkways, ladders, stairs, etc.



Proper cable management



CP 88: Part 1: 2001:

All temporary electrical installations shall be inspected by a Licensed Electrical Worker (LEW) at least once a month.

Where several voltages are used in the temporary installation, all plugs, sockets outlets and cable couplers shall be identified by different colours:

55 V	White
110 V	Yellow
230 V	Blue
400 V	Red



Socket outlets identified by different colours



CP 88: Part 1: 2001:

Warning signage displayed at distribution board shall have the word 'DANGER' and the operating voltage of the equipment:

- in block letters of at least 30mm high and 5mm wide;
- in 4 official languages;
- in black against a yellow background; and
- maintained in a clear and legible condition at all times.

Recommended dimensions : 280mm X 400mm



DB box with warning signage



CP 88: Part 1: 2001:

All plugs, socket-outlets and cable couplers likely to be exposed to the weather shall be contained in waterproof enclosures unless they are of the weatherproof type.



Water-proofed electrical installations



LTA General Specification:

A current photograph of the LEW(s) and the contact number(s) shall be displayed on the outside of all boxes containing DBs for ease of reference.



Display of photo of LEW and contact number

LTA General Specification:

The Contractor shall ensure that all hand-held portable electrical appliances and inspection lamps are rated at 110V AC via a step down transformer centre tapped to earth (CTE).

This page is intended to be left blank.

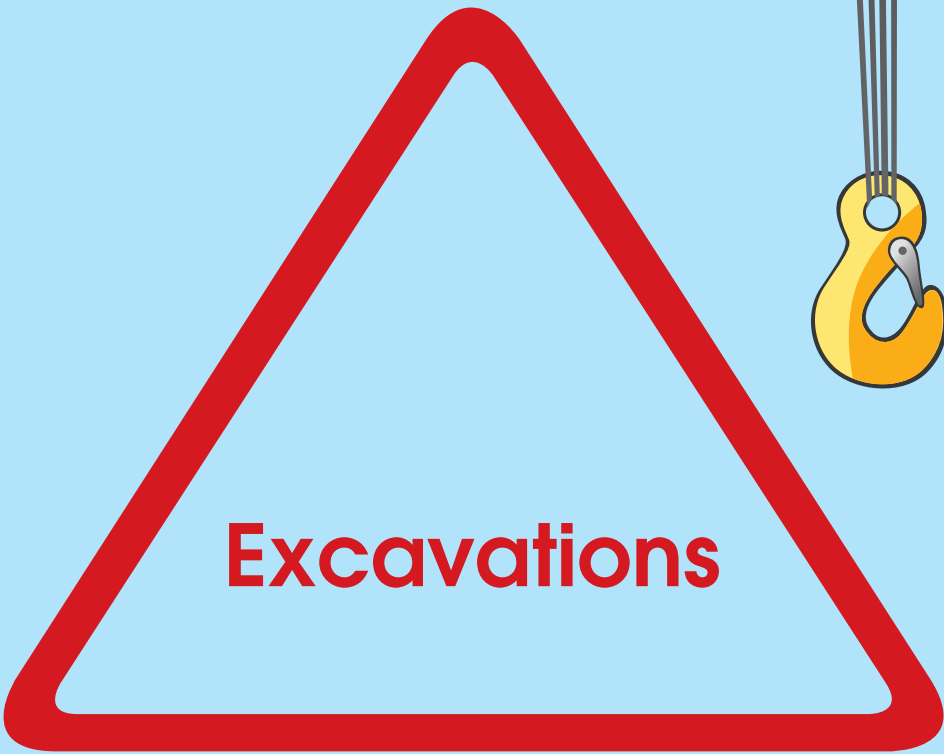



EXCAVATIONS

WSH (Construction) Reg. 77:

Where the depth of any excavation exceeds 1.5 metres or where the banks are undercut, adequate shoring by underpinning, sheet piling, bracing or other means of shoring shall be provided to prevent collapse of the excavation, or any structure adjoining or over areas to be excavated.



*No shoring for excavation
exceeding 1.5m*



WSH (Construction) Reg. 77:

Where the depth of any excavation in a worksite exceed 4 metres, adequate shoring by underpinning, sheet piling, bracing or other means of shoring shall be made or erected in accordance with the design of a professional engineer to prevent collapse of the excavation, or any other structures adjoining or over areas to be excavated.

Ladder secured to guardrail for safe access and egress

Poling boards extend above edges of excavation to act as toeboards

Exposed services are supported

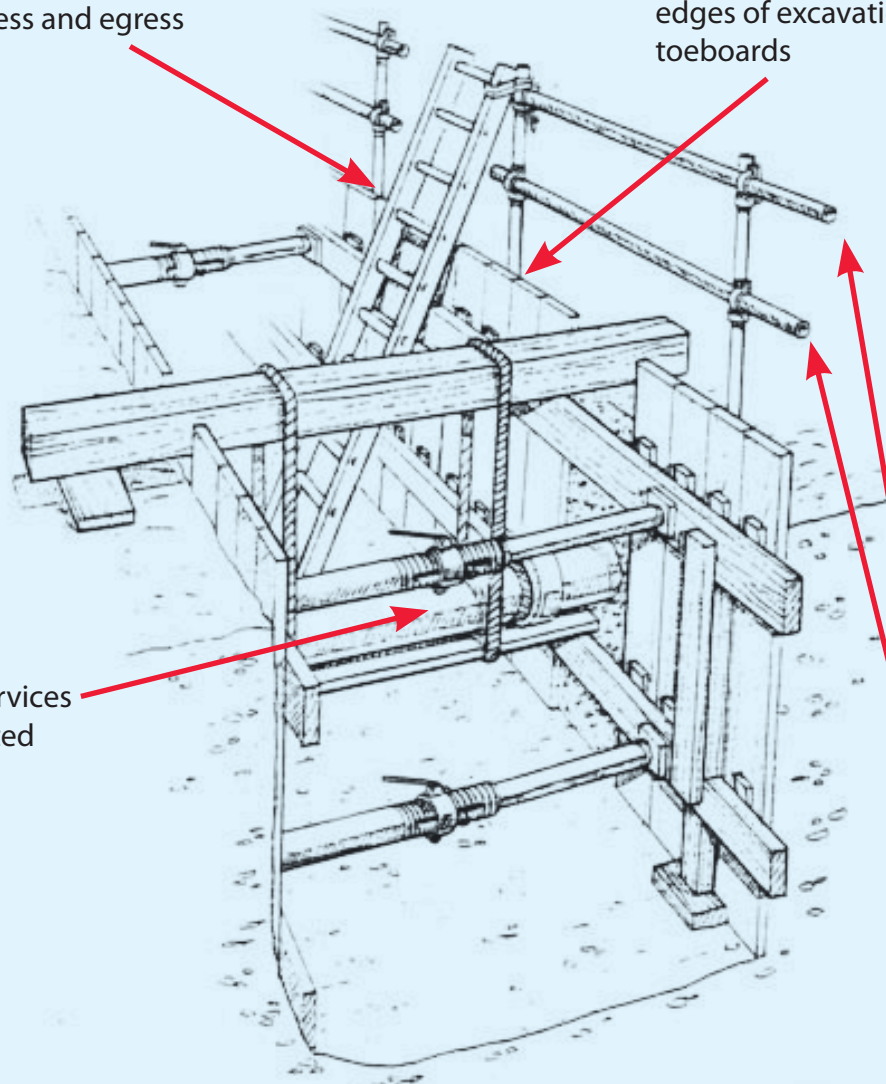

Guardrails



EXCAVATIONS

WSH (Construction) Reg. 77:

The open side of any excavation in a worksite which exceeds 2 metres in depth shall be provided with adequate guard-rails to prevent persons from falling into the excavation.

Notices shall be put up at appropriate and conspicuous positions to warn persons about the excavation in a worksite.



Notices and guardrail provided at excavation zone



Proper guardrail around a shaft



WSH (Construction) Reg. 77:

Excavated material or other superimposed loads shall be placed away from the edge of the excavation in a worksite to prevent the materials or other loads from falling into the excavation, or cause the banks to slip or cause the upheaval of the excavation bed.



Equipment and loose materials placed near edge of excavation



EXCAVATIONS

WSH (Construction) Reg. 77:

All reasonably practicable measures shall be taken during any excavation work in a worksite to prevent any person from:

- a) being trapped by the collapse of the excavation;
- b) being struck by an object, such as an excavating machine or by any material dislodged by the machine;
- c) falling into the excavation; and
- d) inhaling, or otherwise being exposed to, carbon monoxide or other impurity of the air in the excavation.



Working area of excavator was barricaded



WSH (Construction) Reg. 79:

It shall be the duty of the occupier of worksite where any excavation work is carried out to ensure that:

- a) safe access to and egress from the excavation in the worksite is provided where persons are required to work in the excavation; and
- b) the access and egress is sufficient in numbers and installed in such locations so as to be readily accessible.



Provision of well maintained walkway and access into excavation



LTA General Specification:

Proper walkways shall be provided along struts and walers for access and egress. Walkways shall also be provided on planned emergency escape routes.



Proper walkways provided along struts



Walkways were provided to ease evacuation in case of emergencies



LTA General Specification:

Designated walkways along walers and struts shall be levelled, flushed without tripping hazards and with rigid guardrails and toe boards securely provided.



Toe boards and netting are added to prevent loose material from falling into excavation



LTA General Specification:

The Contractor shall implement a RFID (Radio-Frequency Identification) based personnel tracking system for all deep excavation works, underground stations and tunnels on site. The system shall track the movement of workers going in and coming out of these areas.

The system shall :

- a) use high frequency (HF) RFID for close proximity sensing;
- b) allow bi-directional tracking at each access point;
- c) allow location tracking at one or more access points (include tracking of worker's last known location to facilitate emergency rescue works);
- d) provide instant information update and allow user to view the information using standard web browser;
- e) provide real-time count of workers in one or more locations;
- f) trace the entry and exit time of workers at access points;
- g) track the duration of stay of individual workers at each location for each period;
- h) display the total time spent by workers of each trade; and
- i) display the additional information such as personnel name, ID, location and entry time stamp.



RFID Tag taped inside worker's helmet



RFID gantry was erected to track access to and egress from confined space



LTA General Specification:

Excavators within the excavation pit shall have suitably reinforced cabin roofs capable of withstanding impact from falling objects from the top of the excavation and its movement coordinated by one of its operator, who shall be appointed as a leader by the Contractor.



Excavator with reinforced roof



Fire Safety



WSH (General Provisions) Reg. 37:

All reasonably practicable steps shall be taken to keep sources of heat or ignition separate from flammable materials in the factory or any process carried on at the factory that gives rise to any flammable gas or vapour.



Flammable substance stored at designated storage area away from sources of heat



SS 510: 2005:

All gas cylinders shall be kept away from radiators and other sources of heat. In the case of acetylene and LPG cylinders, they should not be stored within 1.5m of an electrical equipment, unless the electrical equipment is of an explosion-proof type.



Gas cylinders placed near to radiator



Gas cylinder with trolley



Valves, couplings, regulators, hoses, and flashback arrestors are kept oil-free

SS 510: 2005:

Cylinders, cylinder valves, couplings, regulators, hoses, flashback arrestors and apparatus of oxygen cylinders shall be kept free from oily or greasy hands or gloves.



SS 510: 2005:

Oxygen cylinders in storage shall be separated from fuel gas cylinders or combustible materials (especially oil or grease), for a minimum distance of 6.0 m or by a non-combustible barrier of at least 1.5m high having a fire-resistance rating of at least ½ hour.



Separation of oxygen and acetylene cylinders by a minimum distance of 6.0m

SS 510: 2005:

No welding, cutting, or other hot work shall be performed on used drums, barrels, tanks or other containers until they have been cleaned so thoroughly as to make absolutely certain that there are no flammable materials present or any substances such as greases, tars, acids or other materials which, when subjected to heat might produce flammable (or toxic) vapours.



SS 510: 2005:

All equipments used (for welding, cutting and other operations involving the use of heat) should be visually examined at the beginning of the day, before being used. All hoses must be checked to ensure they are free from cuts, cracks and other defects. Defective hoses and apparatus must not be used. The gas supply must be shut off at the regulators before any changing of torches, hoses or other parts is done.

Before starting the burning operations, checks must be made to ensure that there is no flammable or combustible material nearby.



Defective hose should not be used



Welding area was kept free from flammable materials. Fire-extinguisher was provided nearby in case of fire



Flammable materials found around the welding area



WSH (General Provisions) Reg. 37:

Means of extinguishing fire shall be provided and maintained and shall be readily accessible, adequate, suitable and tested by a competent person at regular intervals.



*Provision of
fire-extinguishers*



*Fire extinguisher was not
maintained*



WSH (General Provisions) Reg. 38:

There shall be effective warning devices that :

- are capable of being operated without exposing any person to undue risk;
- are maintained and tested at least once every month;
- give warning in case of fire; and
- are clearly audible throughout the factory.



Fire Point



Electrical Fire Alarm



FIRE SAFETY



Fire point complete with sand bags, fire-extinguishers, shovel, and water bucket



Portable Hand Cranking Alarm



WSH (General Provisions) Reg. 38:

Effective steps shall be taken to ensure that all the persons at work are familiar with the means of escape and the routine to be followed in case of fire .



*Display of Emergency
Escape Route*

LTA General Specification:

In-house emergency exercises and drills shall be conducted on a quarterly basis, table-top exercise with SCDF and all relevant agencies on a half-yearly basis while drills on a yearly basis.



SCDF Drill

This page is intended to be left blank.

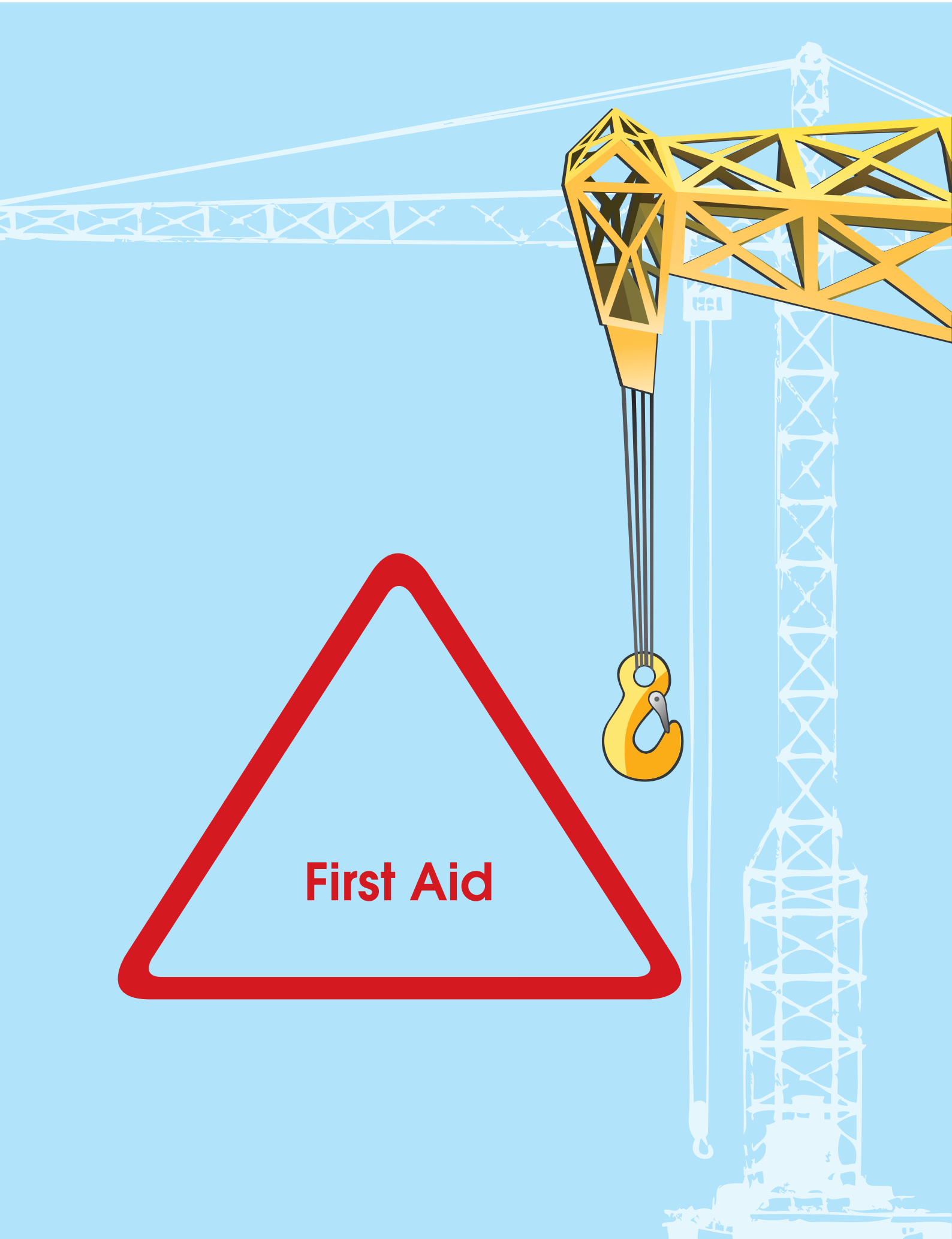



WSH (First Aid) (Amendment) Reg. 5:

Where more than 25 persons are employed in a workplace, there shall be person appointed in the workplace as first-aiders who shall be readily available during working hours such number of persons shall complies with the ratio of one first-aiders for every 100 persons employed in the workplace or part thereof.

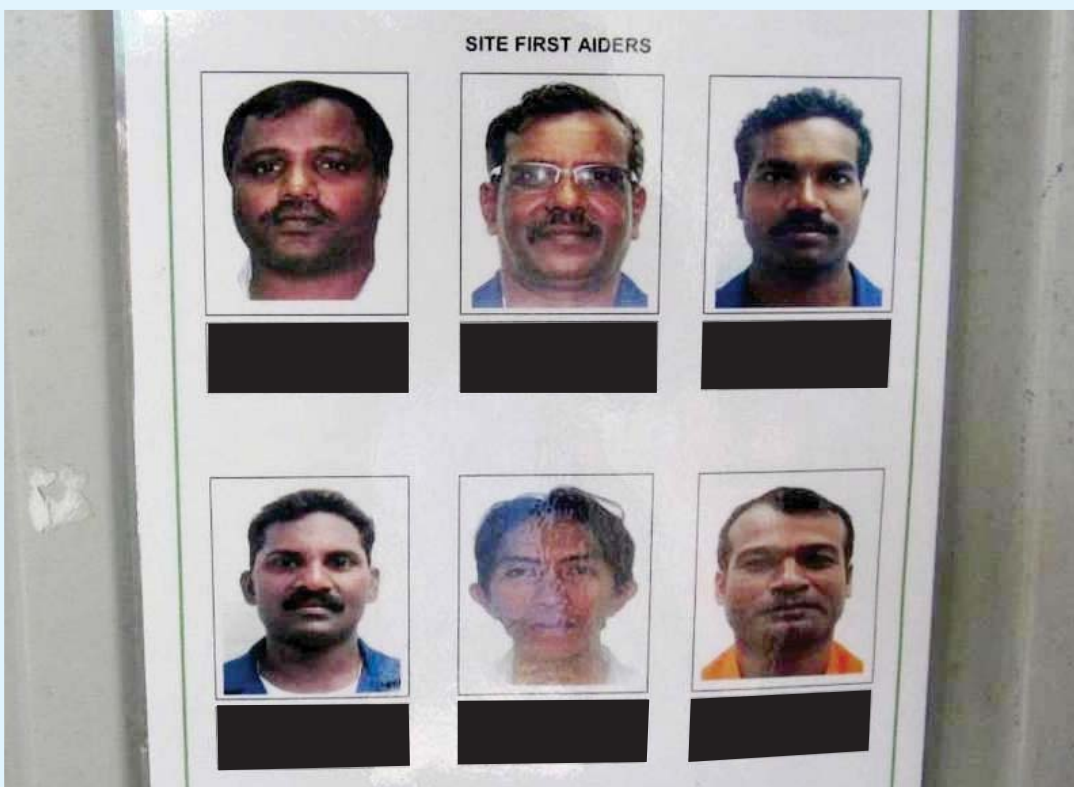

First-aiders were appointed and displayed on prominent areas

LTA General Specification:

Qualified first aiders shall be suitably identified with a logo of a green cross on their safety helmets.



LTA General Specification:

An approved first aid station shall be provided and maintained at all times. The station shall be fully equipped to treat illness and injuries which can normally be expected to occur in work of the types required by this Contract. Medical supplies shall be stocked in the types and quantities recommended by the designated doctor.



*Provision of
proper First Aid
Room*



*Medical supplies properly
maintained*

This page is intended to be left blank.

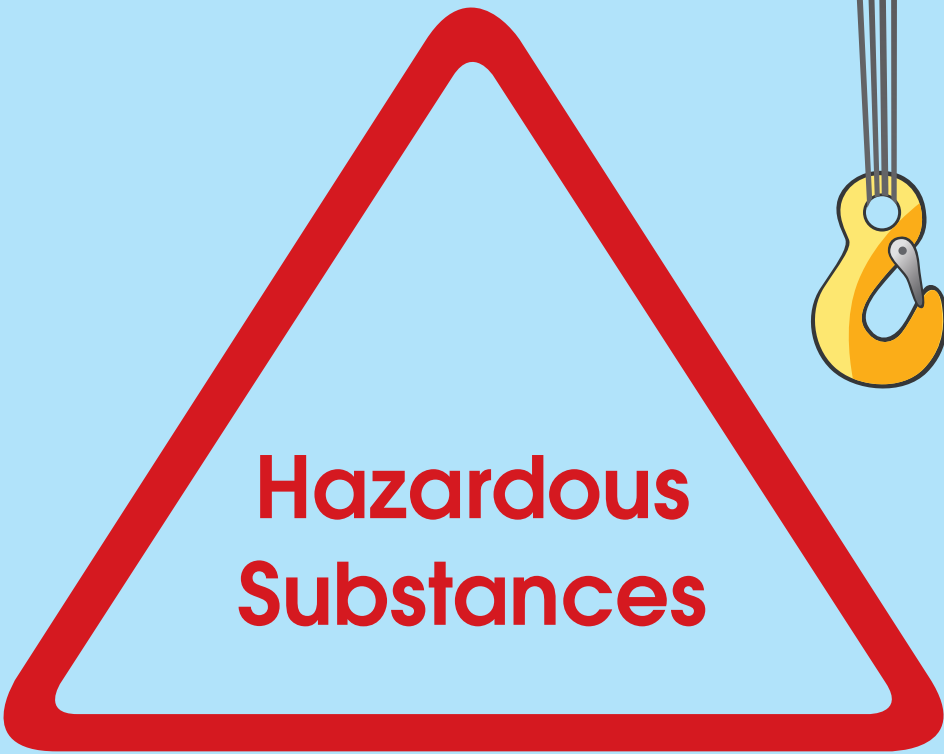

**Hazardous
Substances**



HAZARDOUS SUBSTANCES

WSH (General Provisions) Reg. 41:

Adequate warning notices in languages understood by all persons at work in a factory specifying the nature of the danger of the hazardous substances shall be placed:

- a) at all entrances to any workroom; and
- b) at appropriate locations, where the hazardous substances are used or present.

GHS Pictograms:



CORROSIVE



ACUTE TOXICITY (SEVERE)



ENVIRONMENTAL TOXICITY



GASES UNDER PRESSURE



OXIDISER



**EXPLOSIVE
SELF-REACTIVE
ORGANIC PEROXIDE**



**FLAMMABLE
SELF-REACTIVE
PYROPHORIC
SELF-HEATING
EMITS FLAMMABLE
GAS**



**CARCINOGENICITY
RESPIRATORY SENSITISER
REPRODUCTIVE TOXICITY
TARGET ORGAN TOXICITY
MUTAGENICITY
ASPIRATION TOXICITY**



**IRRITANT
SKIN SENSITISER
ACUTE TOXICITY
NARCOTIC EFFECTS
RESPIRATORY TRACT
IRRITATION**

Sources: <https://www.wshc.sg/ghs>



WSH (General Provisions) Reg. 42:

It shall be the duty of the occupier of a workplace in which there is any container of hazardous substances to ensure that, so far as is reasonably practicable, every such container is affixed with one or more warning labels that conform with:

- a) any Singapore Standard relating to the classification and labelling of hazardous substances; or
- b) such other standards, codes of practice or guidance relating to the classification and labelling of hazardous substances as is issued or approved by the Council.



Chemical drums inappropriately stored and without proper warning label affixed



CP 79: 1999:

The occupier shall establish a control program which shall include:

- a) maintenance of a register of hazardous materials compiled from Safety Data Sheets (SDS);
- b) appointment of a competent person to receive such materials and ensure its safe storage and use;
- c) establishment of procedures for labelling, issue, distribution and use;
- d) communication of the hazards by the competent person to the users;
- e) designation of storage areas secured against unauthorised access; and
- f) procedures for disposal.



Proper chemical storage area with warning signs, hazard classification, safe work practices and PPE needed prominently displayed



LTA General Specification:

The Contractor shall assess the Safety Data Sheets (SDS) of all the hazardous substances and chemicals for its suitability in terms of SHE hazards and consider safer alternatives prior to its entry to site.

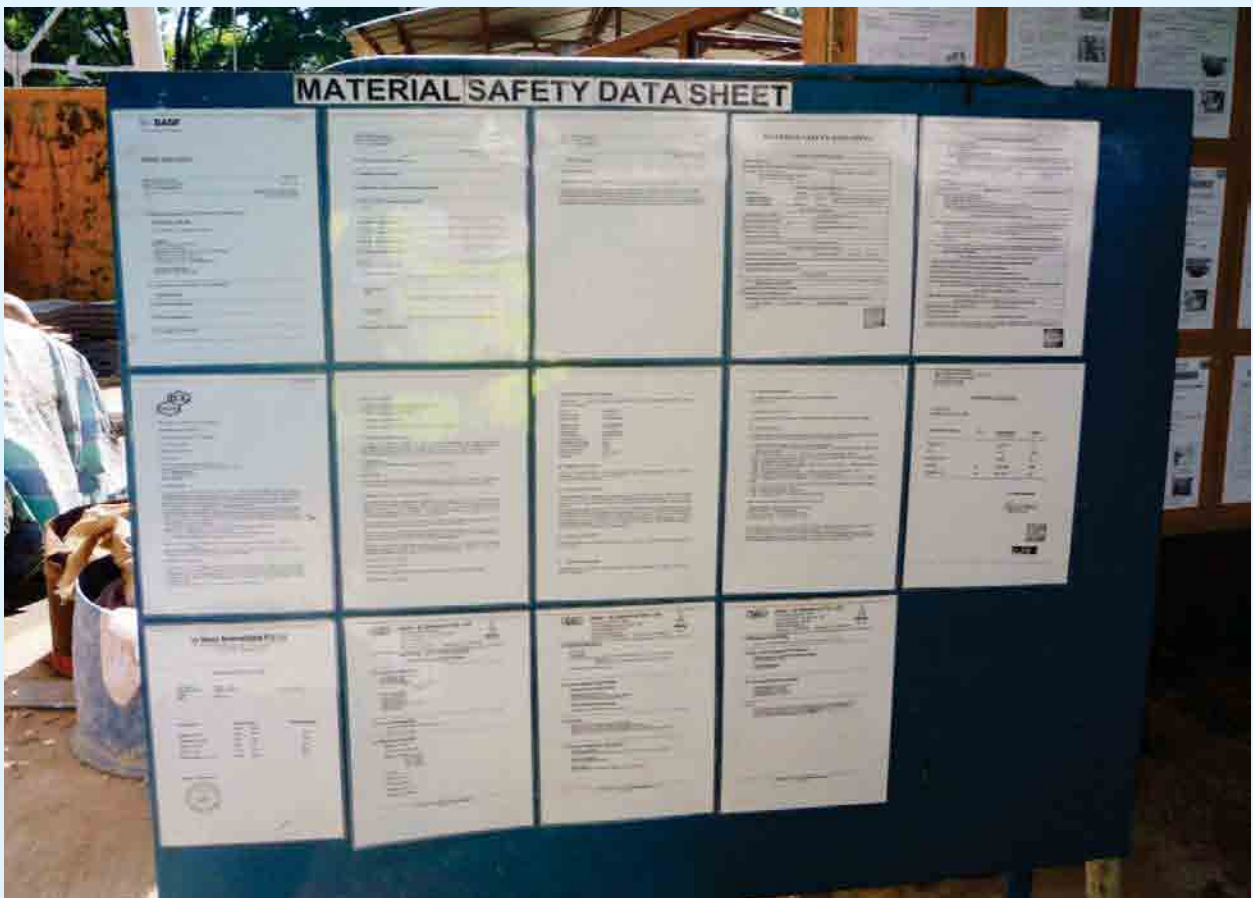

Safety Data Sheet displayed on notice board



LTA General Specification:

The Contractor shall ensure that all hazardous substance or chemical containers are labelled, its movement is recorded and returned to the designated storage areas when not in use.

The Contractor may store petrol up to a maximum volume of 5 litres on Site provided that it is kept in a suitably constructed store which is licensed by the SCDF.



Chemical containers properly labelled



Housekeeping



Construction waste bin placed close to edge of excavation area

WSH (Construction) Reg. 24 (a):

It shall be the duty of the employer of any person who carries out the work of storing, stacking or placing materials or equipment in a worksite to ensure that the material or equipment is not stored, stacked or placed so close to any opening or edge of a floor, scaffold, platform or structure as to endanger persons below the opening or edge.

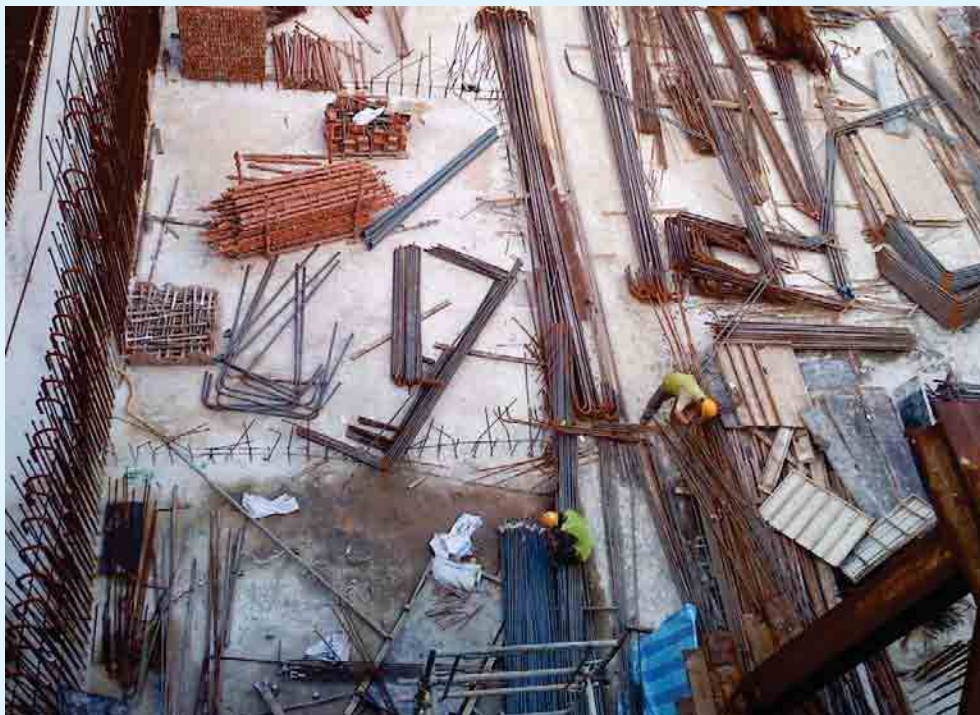

Scattered construction materials



Improper storing and stacking of unused materials



WSH (Construction) Reg. 27 (b):

Any sharp projection which is present in any passageway, stair, platform and other means of access or place of work in the worksite and which may injure any person is removed or otherwise made safe.

LTA General Specification:

The Contractor shall provide capping on all protruding starter reinforcement bars with individual plastic/ rubber caps or with hose/ tube.



Protruding objects at eye level



Protruding objects were capped



LTA General Specification:

The Contractor shall implement a 5S housekeeping method approved by the Engineer. The method shall be based on a Japanese quality management concept based on cyclical methodology. The 5S shall consist of Seiri, Seiton, Seiso, Seiketsu and Shitsuke.



Sources :

1. <http://www.lean.state.mn.us/photos.htm>

2. <https://www.wshc.sg/wps/themes/html/upload/event/file/3%205S%20MATL%20SKS.pdf>



DEFINITION OF 5S

- **Seiri (Sort/ Organise)**
Focus on sorting out unnecessary items and disposing them away from the site.
- **Seiton (Set in Place/ Orderliness)**
Arrange the necessary items in a neat, proper manner for easy retrieval and to return them to their original locations.
- **Seiso (Sweep/ Shine/ Cleanliness)**
Thoroughly clean and inspect the site.
- **Seiketsu (Standardise)**
Maintain a high standard of housekeeping at site by keeping everything clean and orderly at all times.
- **Shitsuke (Sustain/ Discipline)**
Train people to follow good housekeeping standards, and to inculcate self-discipline through continuous practice.

Thus, by adopting the 5S model, a site with good housekeeping and maintenance will be ensured.



Stoppers were placed to prevent the rebar cages from rolling over to the pedestrian pathway



Materials were segregated and stored neatly



Materials were segregated and stored in an organised and orderly manner



Materials were segregated and stored in an organised and orderly manner



Workers sweeping floor to keep the walkway clean



Using vacuum cleaner to prevent dust accumulation in the station box

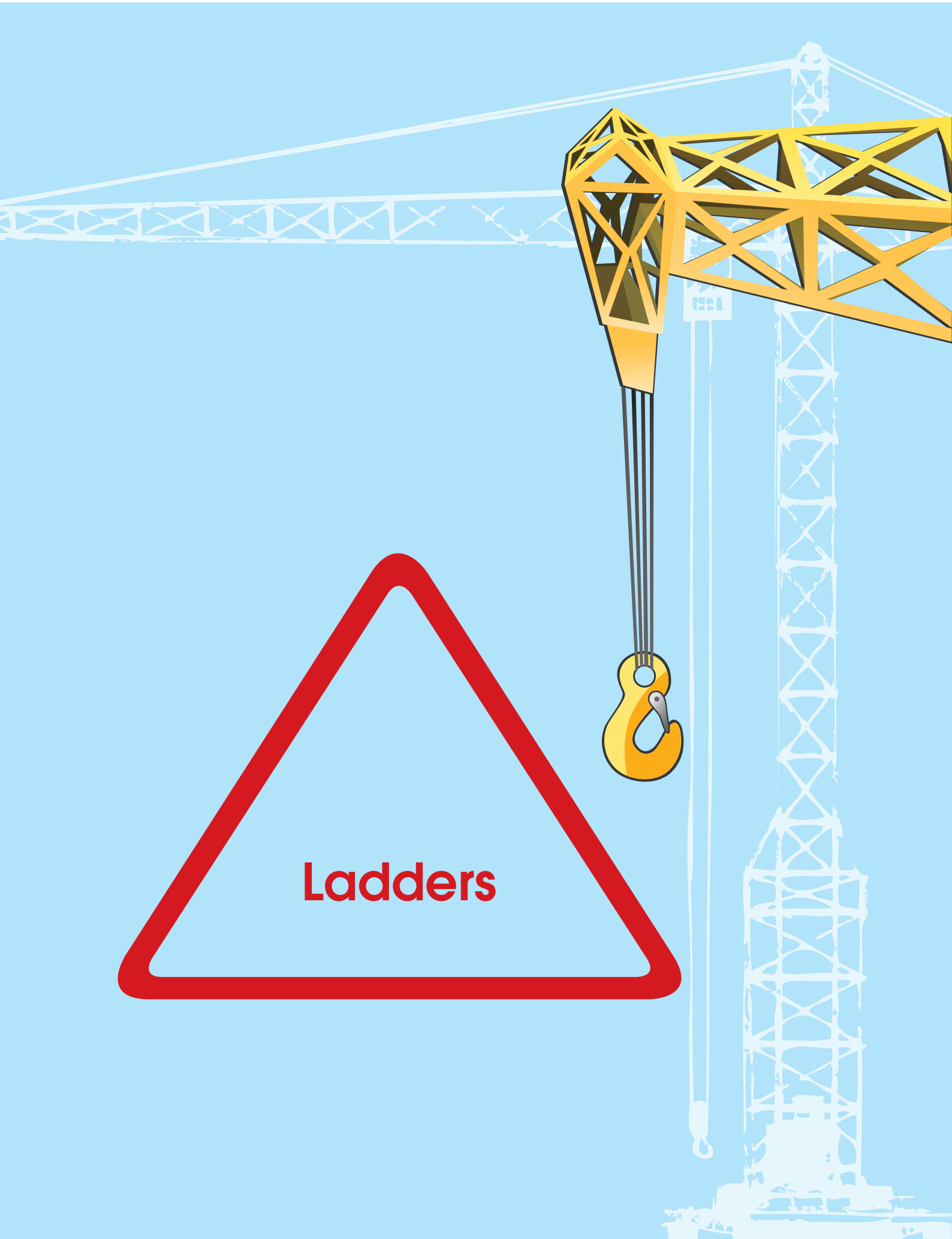



LADDERS

WSH (Construction) Reg. 44:

Every ladder in the worksite shall be positioned and securely fixed when used by any person carrying out any work so as to prevent slipping, swaying or sagging.

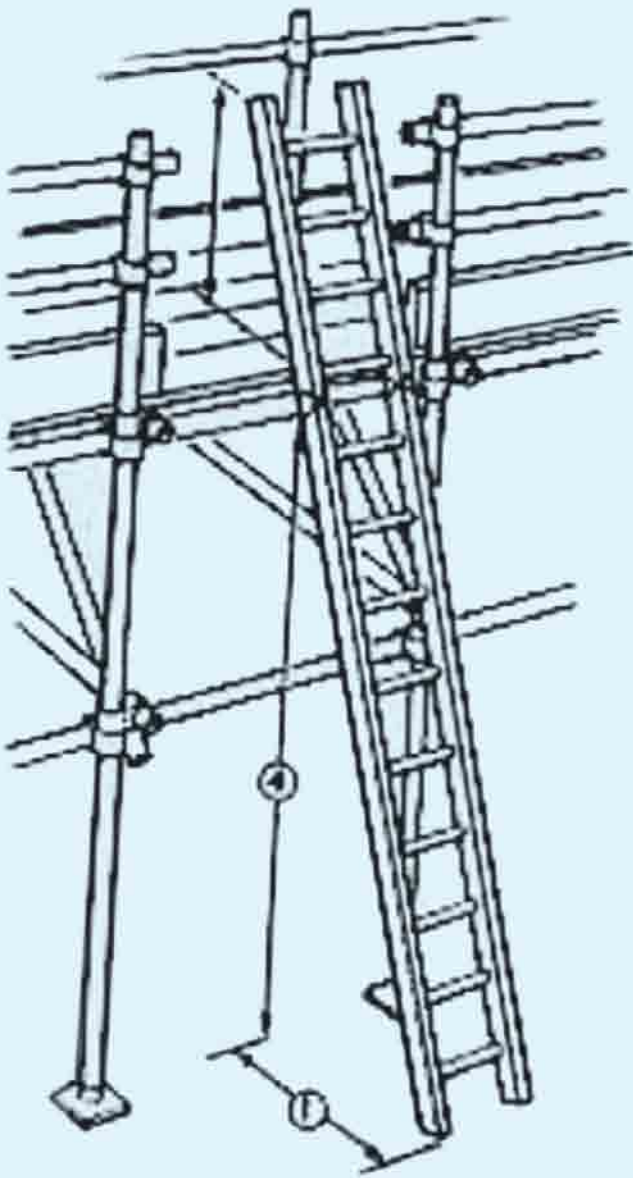

Ladders should be secured during use





No proper landing platform, ladder not secured



Secured ladders



Crooked and unsecured ladder should be removed from site



LADDERS



LTA General Specification:

No vertical access ladders exceeding three meters in length is allowed on site.



Landing was provided but at an interval exceeding 3 meters



**Lifting
Operations**



LIFTING OPERATIONS

WSH (General Provisions) Reg. 21:

Every lifting appliance and lifting machine shall be thoroughly examined by an authorised examiner at least once every year (once in every 6 months for LTA projects) or such other intervals as the Commissioner may determine.

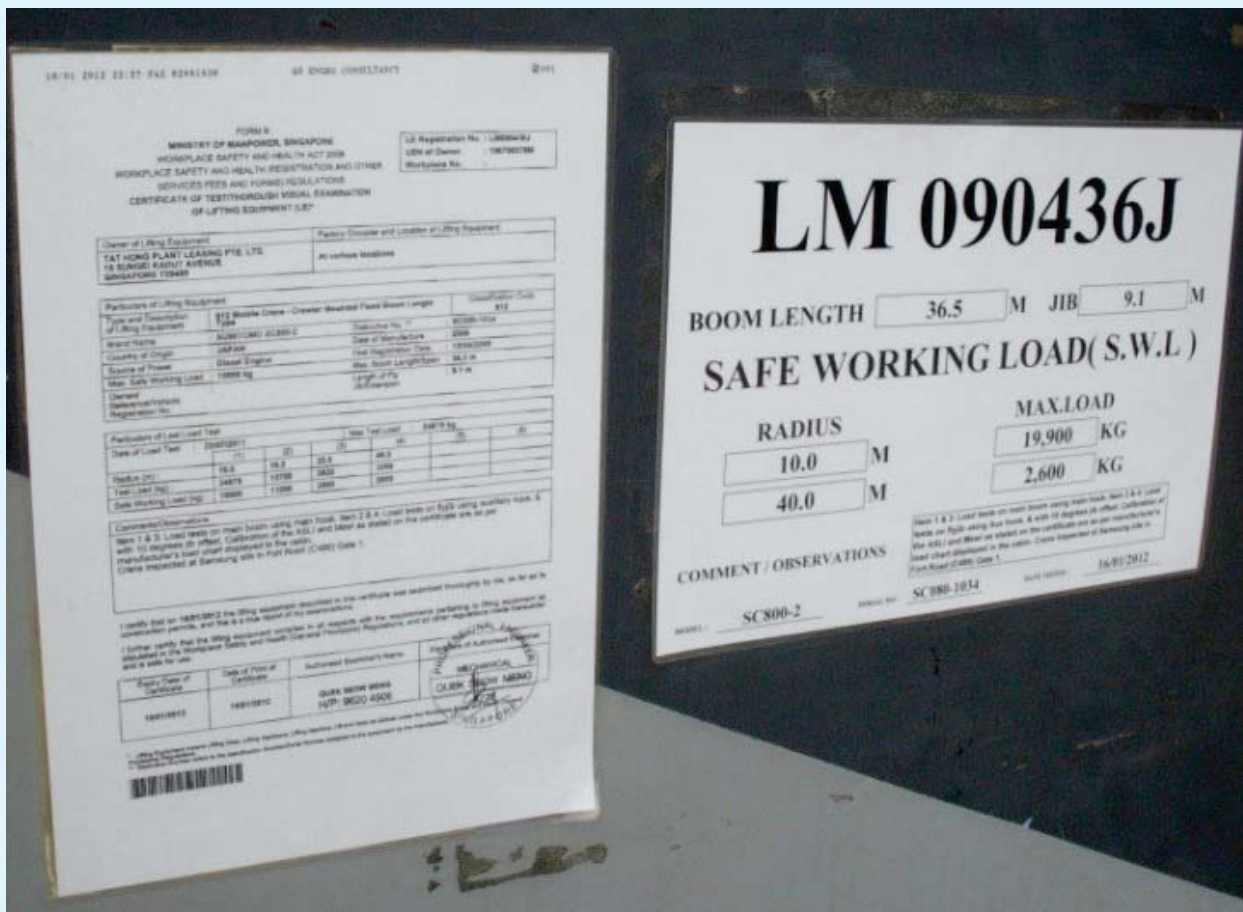

LM certificate displayed on crane



WSH (Operation of Cranes) Reg. 4:

Where any lifting operation involving the use of any crane is carried out in a workplace by a crane operator, it shall be the duty of the responsible person to establish and implement a lifting plan which shall be in accordance with the generally accepted principles of safe and sound practice.

It shall be the duty of the responsible person to ensure that the lifting plan is made available for inspection upon request by an inspector.

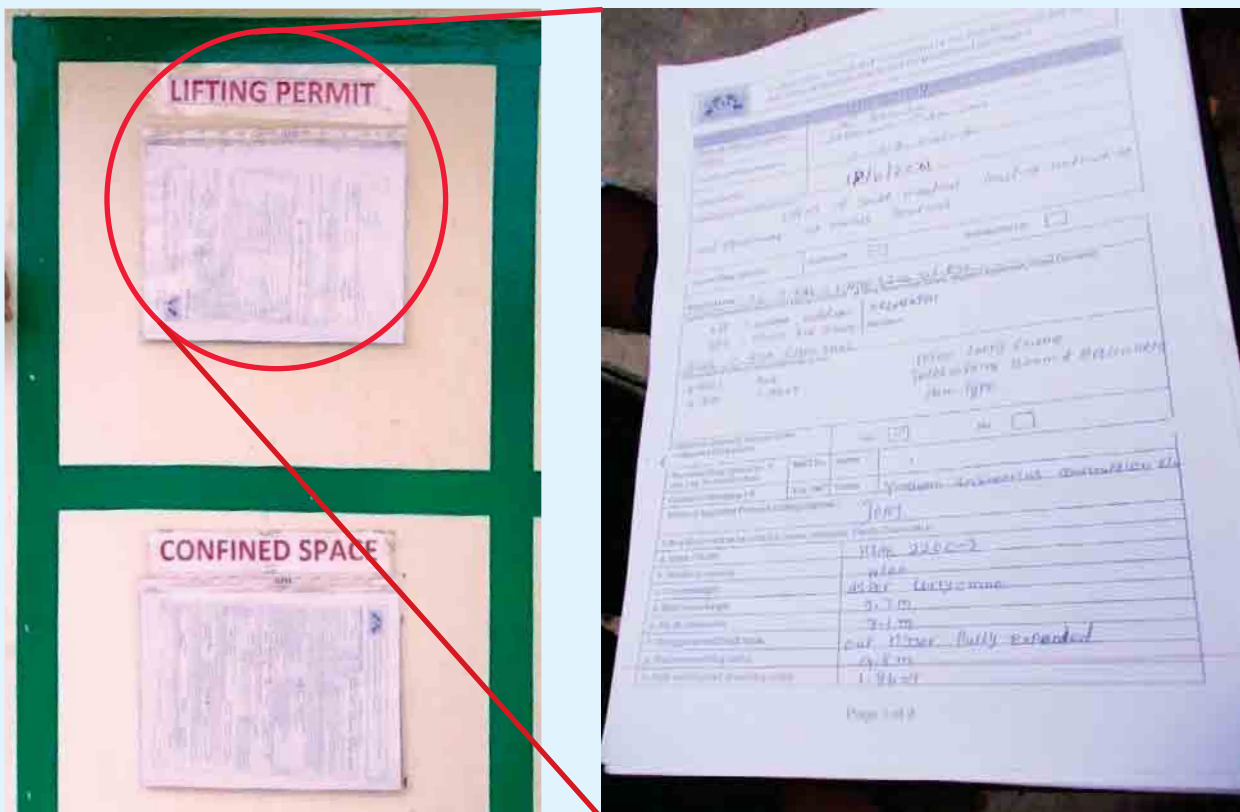

A copy of Lifting Plan was displayed with the Lifting Permit



WSH (Operation of Cranes) Reg. 16 (c):

The crane operator need to ensure that any outrigger when it is required is fully extended and secured.



Outriggers not fully extended



Outriggers resting on plank



WSH (Construction) Reg. 134:

It shall be the duty of the operator of a crane or material handling machinery being used in a worksite to ensure that the crane or machinery, as the case may be, is positioned and operated as to be stable.



Plank is not suitable to serve as outrigger platform because it does not provides a firm footing to the crane during lifting



LTA General Specification:

Steel plates of minimum dimensions 1m X 1m X 25mm shall be placed under all the outriggers of any lorry mounted mobile crane deployed for a lifting operation unless that crane is entirely sited on hard standing such as a reinforced concrete surface, with no void underneath.



Correct placement of steel plates for outriggers (outriggers fully extended)



Steel plates were lined along the crane access to ensure crane stability in preparation for lifting operation



LIFTING OPERATIONS



Lifting area demarcated with warning signages



Interlocking device for outriggers



WSH (General Provisions) Reg. 21:

Every lifting appliances and lifting machine in the case of a jib crane so constructed that the safe working load may varied by the raising or lowering of the jib, shall have an accurate indicator, which must be placed so as to be clearly visible to the driver of the jib crane, that shows the radius of the jib at any time and the safe working load corresponding to that radius.

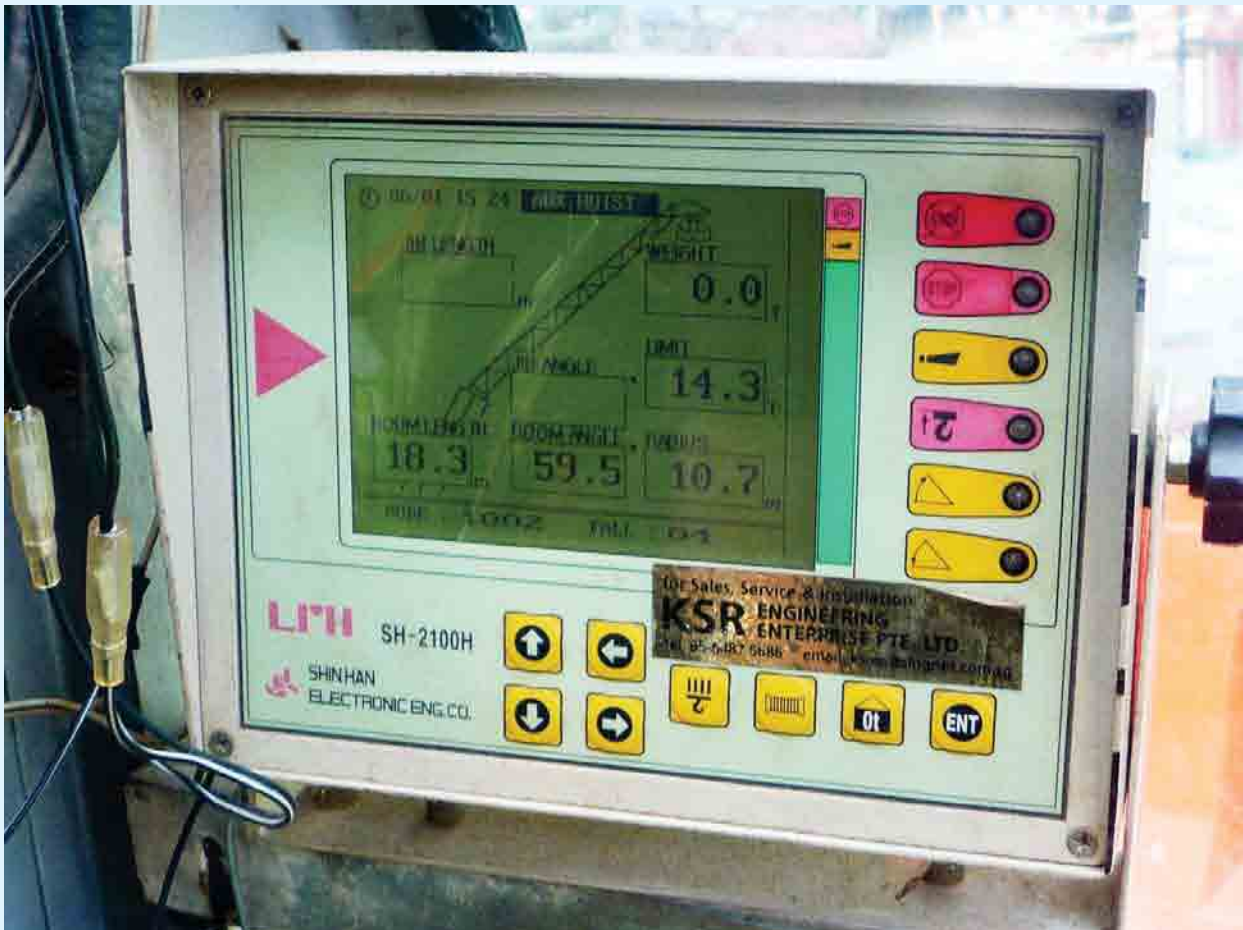

Indicator showing the boom length, boom angle, radius, weight of load, safe working load



WSH (Construction) Reg. 135:

The capacity chart shall:

- a) be posted and maintained in the crane which is clearly visible to the operator;
- b) set out the safe loads for various lengths of jib at various angles and radial distances; and
- c) be prepared and certified by an authorised examiner, unless it is furnished by the manufacturer or builder of the crane.

KH850-3 クローラクレーン補助ジブ付主ブーム定格総荷重表 (マスト無)

ブーム長さ(m) 作業半径(m)	18	21	24	27	30	33	36	39	42	45	48	51	54	57	60	63	単位 t
5.0	140.5	129.5															5.0
6.0	141.2	129.5	121.5														5.5
7.0	141.9	129.5	121.5	111.5													6.0
8.0	142.6	129.5	121.5	111.5	100.5	89.5t	8.1m×	8.6m×									6.5
9.0	143.3	129.5	121.5	111.5	95.3	84.4	83.3	80.2t	80.2t	9.2m×	9.7m×						7.0
10.0	144.0	129.5	121.5	111.5	90.7	80.2t	80.2t	80.2t	68.5t	68.5t	10.2m×	10.7m×	11.2m×	11.8m×			7.5
11.0	144.7	129.5	121.5	111.5	86.0	77.1	72.0	71.5	68.5	68.5	58.3t	58.3t	47.0t	47.0t	12.3m×	12.8m×	8.0
12.0	145.4	129.5	121.5	111.5	81.4	72.0	67.3	66.8	63.7	63.7	54.0	54.0	44.0	44.0	45.5t	35.5t	8.5
13.0	146.1	129.5	121.5	111.5	76.8	67.3	62.6	62.1	59.0	59.0	50.0	50.0	40.0	40.0	41.5	35.5	9.0
14.0	146.8	129.5	121.5	111.5	72.1	62.6	57.9	57.4	54.3	54.3	46.0	46.0	36.0	36.0	38.1	35.5	9.5
15.0	147.5	129.5	121.5	111.5	67.5	57.9	53.2	52.7	49.6	49.6	42.0	42.0	32.0	32.0	30.1	30.1	10.0
16.0	148.2	129.5	121.5	111.5	62.8	53.2	48.5	48.0	45.4	45.4	38.0	38.0	30.0	30.0	28.8	25.8	10.5
17.0	148.9	129.5	121.5	111.5	58.1	48.5	44.4	43.9	41.3	41.3	34.0	34.0	26.0	26.0	25.8	22.0	11.0
18.0	149.6	129.5	121.5	111.5	53.4	43.9	39.8	39.3	37.2	37.2	30.0	30.0	22.0	22.0	22.4	22.4	11.5
19.0	150.3	129.5	121.5	111.5	48.7	39.3	35.2	34.7	32.6	32.6	26.0	26.0	18.0	18.0	19.7	19.7	12.0
20.0	151.0	129.5	121.5	111.5	44.0	34.7	30.6	30.1	28.0	28.0	22.0	22.0	14.0	14.0	17.4	17.4	12.5
21.0	151.7	129.5	121.5	111.5	39.3	30.1	26.5	26.0	24.4	24.4	18.0	18.0	10.0	10.0	15.8	15.8	13.0
22.0	152.4	129.5	121.5	111.5	34.6	25.5	22.4	21.9	20.3	20.3	14.0	14.0	6.0	6.0	14.2	14.2	13.5
23.0	153.1	129.5	121.5	111.5	29.9	20.9	18.3	17.8	16.2	16.2	10.0	10.0	2.0	2.0	12.6	12.6	14.0
24.0	153.8	129.5	121.5	111.5	25.2	16.2	14.2	13.7	12.1	12.1	6.0	6.0			11.0	11.0	14.5
25.0	154.5	129.5	121.5	111.5	20.5	11.5	9.8	9.3	7.7	7.7	2.0	2.0			10.5	10.5	15.0
26.0	155.2	129.5	121.5	111.5	15.8	6.8	5.1	4.6	3.0	3.0					9.0	9.0	15.5
27.0	155.9	129.5	121.5	111.5	11.1	2.1	0.4	0.0	0.0	0.0					7.5	7.5	16.0
28.0	156.6	129.5	121.5	111.5	6.4	0.0	0.0	0.0	0.0	0.0					6.0	6.0	16.5
29.0	157.3	129.5	121.5	111.5	1.7	0.0	0.0	0.0	0.0	0.0					4.5	4.5	17.0
30.0	158.0	129.5	121.5	111.5	0.0	0.0	0.0	0.0	0.0	0.0					3.0	3.0	17.5
31.0	158.7	129.5	121.5	111.5	0.0	0.0	0.0	0.0	0.0	0.0					1.5	1.5	18.0
32.0	159.4	129.5	121.5	111.5	0.0	0.0	0.0	0.0	0.0	0.0					0.0	0.0	18.5
33.0	160.1	129.5	121.5	111.5	0.0	0.0	0.0	0.0	0.0	0.0					0.0	0.0	19.0
34.0	160.8	129.5	121.5	111.5	0.0	0.0	0.0	0.0	0.0	0.0					0.0	0.0	19.5
35.0	161.5	129.5	121.5	111.5	0.0	0.0	0.0	0.0	0.0	0.0					0.0	0.0	20.0
36.0	162.2	129.5	121.5	111.5	0.0	0.0	0.0	0.0	0.0	0.0					0.0	0.0	20.5
37.0	162.9	129.5	121.5	111.5	0.0	0.0	0.0	0.0	0.0	0.0					0.0	0.0	21.0
38.0	163.6	129.5	121.5	111.5	0.0	0.0	0.0	0.0	0.0	0.0					0.0	0.0	21.5
39.0	164.3	129.5	121.5	111.5	0.0	0.0	0.0	0.0	0.0	0.0					0.0	0.0	22.0
40.0	165.0	129.5	121.5	111.5	0.0	0.0	0.0	0.0	0.0	0.0					0.0	0.0	22.5
41.0	165.7	129.5	121.5	111.5	0.0	0.0	0.0	0.0	0.0	0.0					0.0	0.0	23.0
42.0	166.4	129.5	121.5	111.5	0.0	0.0	0.0	0.0	0.0	0.0					0.0	0.0	23.5
43.0	167.1	129.5	121.5	111.5	0.0	0.0	0.0	0.0	0.0	0.0					0.0	0.0	24.0
44.0	167.8	129.5	121.5	111.5	0.0	0.0	0.0	0.0	0.0	0.0					0.0	0.0	24.5
45.0	168.5	129.5	121.5	111.5	0.0	0.0	0.0	0.0	0.0	0.0					0.0	0.0	25.0
46.0	169.2	129.5	121.5	111.5	0.0	0.0	0.0	0.0	0.0	0.0					0.0	0.0	25.5
47.0	169.9	129.5	121.5	111.5	0.0	0.0	0.0	0.0	0.0	0.0					0.0	0.0	26.0
48.0	170.6	129.5	121.5	111.5	0.0	0.0	0.0	0.0	0.0	0.0					0.0	0.0	26.5
49.0	171.3	129.5	121.5	111.5	0.0	0.0	0.0	0.0	0.0	0.0					0.0	0.0	27.0
50.0	172.0	129.5	121.5	111.5	0.0	0.0	0.0	0.0	0.0	0.0					0.0	0.0	27.5
51.0	172.7	129.5	121.5	111.5	0.0	0.0	0.0	0.0	0.0	0.0					0.0	0.0	28.0
52.0	173.4	129.5	121.5	111.5	0.0	0.0	0.0	0.0	0.0	0.0					0.0	0.0	28.5
53.0	174.1	129.5	121.5	111.5	0.0	0.0	0.0	0.0	0.0	0.0					0.0	0.0	29.0
54.0	174.8	129.5	121.5	111.5	0.0	0.0	0.0	0.0	0.0	0.0					0.0	0.0	29.5
55.0	175.5	129.5	121.5	111.5	0.0	0.0	0.0	0.0	0.0	0.0					0.0	0.0	30.0

1 上表に示す定格総荷重表は水平堅土上、定格荷況における値。転倒荷重の78%以内及び反り曲率の構造規格に定める前方安定度1.5以上です。

2 床面ごとの上げられる荷重は、上表の定格総荷重からフック等のつり荷一切の重量を差し引いた値です。

3 本表の値は重量に基づいてますので荷重を上げるとブーム、フレイム、等も破損する可能性があります。

4 カンテラフックは、5tまでです。

5 作業を行うときは、必ずロープを点検してください。

6 表上ロープ掛数と定格総荷重の最大値およびフック重量。



Capacity chart displayed in language (Japanese) not comprehensible to the crane operator and lifting supervisor



LIFTING OPERATIONS

LIFTING CAPACITIES (TUBULAR)													
0	18.288		21.966		24.384		27.432		30.480		33.528		
ANGLE (°)	LIFTING CAPACITY (t)	ANGLE (°)	LIFTING CAPACITY (t)	ANGLE (°)	LIFTING CAPACITY (t)	ANGLE (°)	LIFTING CAPACITY (t)	ANGLE (°)	LIFTING CAPACITY (t)	ANGLE (°)	LIFTING CAPACITY (t)	ANGLE (°)	LIFTING CAPACITY (t)
90.0													
78.0													
76.1	45.0	78.5											
74.1	38.8	76.9	38.8	78.8									
72.2	33.4	75.2	33.5	77.4	33.5	79.0							
68.1	26.5	71.9	26.5	74.6	26.5	76.6	26.4	78.1	26.2	79.3			
64.0	21.9	68.6	21.8	71.8	21.7	74.1	21.7	75.9	21.6	77.4	21.5	78.5	21.4
59.7	18.7	65.2	18.6	68.9	18.5	71.7	18.4	73.8	18.3	75.4	18.3	76.8	18.2
55.1	16.3	61.6	16.2	66.0	16.1	69.2	16.0	71.6	15.9	73.5	15.9	75.0	15.8
45.1	12.7	54.1	12.6	59.9	12.5	64.0	12.4	67.1	12.3	69.5	12.3	71.4	12.2
32.8	10.4	45.8	10.3	53.4	10.2	58.6	10.1	62.4	10.0	65.4	9.9	67.8	9.8
	8.7	36.0	8.6	46.3	8.5	52.9	8.4	57.6	8.3	61.2	8.2	64.0	8.1
			7.4	38.1	7.3	46.6	7.2	52.4	7.1	56.8	7.0	60.1	6.9
			6.6	30.3	6.3	39.6	6.2	46.9	6.1	52.1	6.0	56.1	5.9
			5.6	29.6	5.5	31.4	5.4	40.8	5.3	47.1	5.2	51.8	5.1
							4.7	33.8	4.6	41.7	4.5	47.3	4.4
							4.3	30.1	4.1	35.6	4.0	42.4	3.9
							3.7	27.5	3.7	30.3	3.6	37.0	3.5



Capacity chart in language (English) understood by the crane operator and lifting supervisor

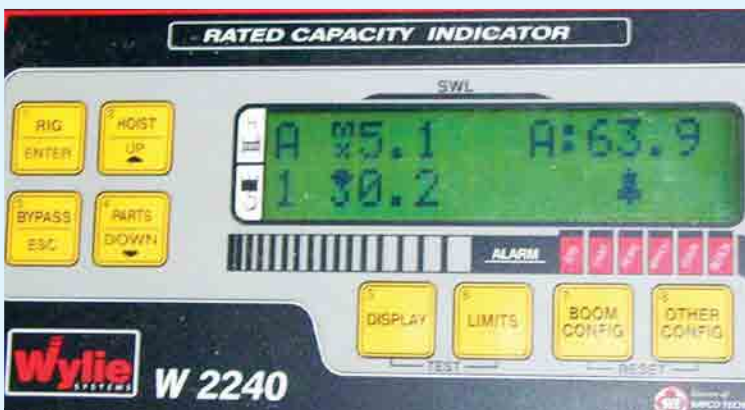

Load capacity indicator



SS 536:2008:

Hook block shall not be allowed to hit the boom tip. Operator shall exercise care when hoisting up or telescoping out of the boom to provide sufficient length of wire rope. Two-block damage-preventing devices shall be fitted.



*Sensing devices to
Over-Hoisting Limit
Switch*

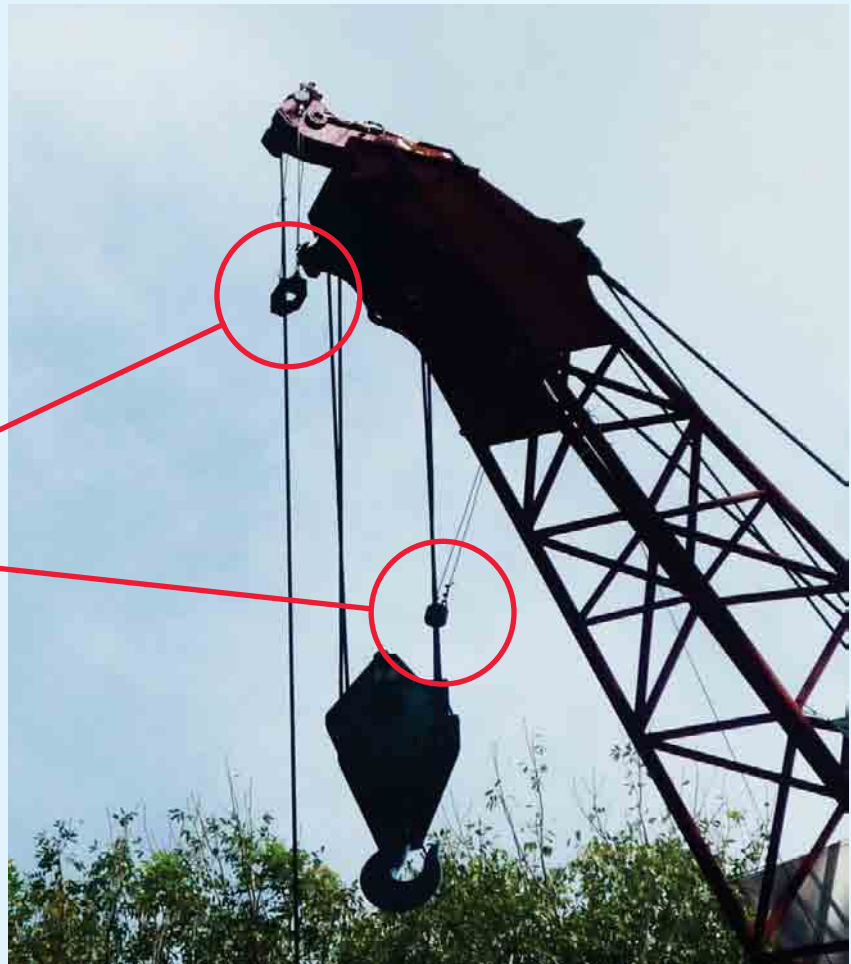



SS 536: 2008:

Load hooks shall be provided with a swivel and safety latch.

The rated capacity of the lifting hooks shall be clearly and permanently marked on them.

The dead weight of the hooks shall also be clearly marked.



Load hooks with swivel and safety latch



No safety latch



SS 536:2008:

For cranes with derricking jibs, the maximum boom angle shall be 80° to the horizontal except for tower arrangements and automatic means shall be provided to stop the boom hoisting operation from exceeding the maximum allowable angle.



Boom angle indicator





LTA General Specification:

Cranes fitted with a load radius indicator (LRI) shall sound an audible alarm in the crane cab if its safe working load is exceeded on either the main or auxiliary hook. A second alarm connected to the LRI, shall be fitted external to the cab and shall emit a signal of a sufficient volume to make it audible above the ambient site noise levels during working hours. Visual warning shall also be provided externally to indicate safe working range and overload conditions.



Visual warning light installed on crane for night work :

*Green (within SWL),
Amber (reaching SWL)
Red (exceeded SWL)*



Externally fitted audible alarm



WSH (Construction) Reg. 137:

Ensure that loads that have a tendency to swing or turn freely during hoisting are controlled by tag-lines.



Use of tag-line in lifting operation



CP 536: 2008:

Use of more than one crane shall be carefully planned out by a competent person in detail with emergency plans. Key points to note:

- a) lifting operations shall be carried out under proper supervision;
- b) supervisor and operators fully understand the operation;
- c) cranes used to be of similar characteristics, eg. hoisting, derricking, slewing, travel speeds;
- d) each crane to have at least 25% excess capacity than the maximum share of the load;
- e) lifting gears are of adequate size and capacity for the operation;
- f) hoist line of cranes shall always be vertical; and
- g) crane shall not be used to perform a duty which is not a normal crane operation.



*Lifting using
2 cranes
under proper
supervision*



LTA General Specification:

The Contractor shall ensure that no lifting operation shall be carried out on site using the auxiliary hook of a mobile crane unless the SWL of this is shown on the LM certificate in addition to that of the main hook block, and is not exceeded.

Particulars of Last Load Test						
Date of Load Test :	19/10/2011			Max Test Load :	19375 kg	
	(1)	(2)	(3)	(4)	(5)	(6)
Radius (m) :	12.0	42.0				
Test Load (kg) :	19375	1625				
Safe Working Load (kg) :	15500	1300				
Comments/Observations						
Advise to maintain safe use of LE Loc- C483 Gate 3 Aux line SWL 6t/16m						



The SWL of the auxiliary hook and the main hook is shown on the LM certificate



Crane information, including SWL of auxiliary line prominently displayed on crane



LTA General Specification:

Minimum clearance of 600mm between the crane and any fixture or other machinery.

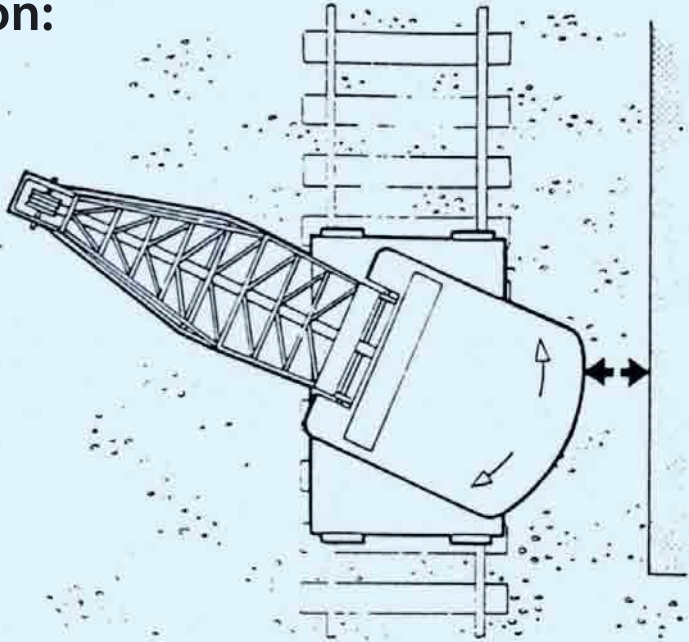

Provision of clearance more than 600mm



LTA General Specification:

No excavator shall be used as a lifting machine on site unless it is originally designed and manufactured to also function as a lifting machine and complies with all MOM stipulated requirements.

List of MOM requirements for excavator to perform lifting functions :

- a) the excavator has been originally designed and manufactured to also function as a lifting machine;*
- b) the excavator shall be equipped with original hook(s) with safety catch for hoisting purposes;*
- c) the excavator shall have a load capacity chart furnished by the manufacturer or builder;*
- d) the excavator shall be equipped with an accurate indicator which shows clearly to the operator, the working radius and the corresponding safe working load at all times and gives a warning signal when the radius is unsafe; and*
- e) any other applicable requirements as stipulated in the WSH Act and its subsidiary legislations.*



Indicator with working radius and corresponding SWL



LIFTING OPERATIONS

LIFTWATCH 5 RATED CAPACITY INDICATOR

THIS MACHINE IS EQUIPPED WITH A LIFTWATCH 5 (L5) RCI. THIS SYSTEM FULLY COMPLIES WITH AS/NZS 1757:1986

PLEASE READ AND UNDERSTAND THE OPERATING INSTRUCTIONS BEFORE USING THIS EQUIPMENT

MACHINE TYPE	KOBELCO SK200vi
SERIAL No	
EQUIPMENT	5m65 (Monoboom) + 2m94, 600mm Track pads, 0.80m ² SAE heaped bucket
DATE	26 June 2003
LIFTING DUTY	2 360° @ 75% of tipping load

	3.0	3.5	4.0	4.5	5.0	5.5	6.0	6.5	7.0	7.5	8.0
7.0							3.67	3.16			
6.5							3.66	3.17			
6.0							3.64	3.17	2.76		
5.5							3.61	3.14	2.75	2.41	
5.0						4.10	3.56	3.11	2.73	2.40	
4.5					4.68	4.03	3.50	3.06	2.70	2.38	2.10
4.0			6.41	5.36	4.57	3.94	3.43	3.01	2.66	2.35	2.08
3.5	9.45	7.53	6.19	5.20	4.45	3.85	3.36	2.96	2.61	2.32	2.06
3.0	8.92	7.20	5.96	5.04	4.32	3.75	3.28	2.90	2.57	2.29	2.04
2.5		6.89	5.75	4.88	4.20	3.65	3.21	2.84	2.52	2.25	2.01
2.0		6.64	5.55	4.73	4.08	3.56	3.14	2.78	2.48	2.21	1.98
1.5		6.45	5.40	4.60	3.98	3.48	3.07	2.72	2.43	2.18	1.96
1.0		6.33	5.28	4.50	3.89	3.41	3.01	2.68	2.39	2.15	1.94
0.5	4.51a	6.25	5.19	4.42	3.82	3.35	2.96	2.63	2.36	2.12	1.92
0.0	5.75a	6.21	5.13	4.36	3.77	3.30	2.92	2.60	2.33	2.10	1.90
-0.5	7.15a	6.19	5.10	4.32	3.73	3.26	2.88	2.57	2.31	2.08	1.89
-1.0	7.84	6.18	5.08	4.29	3.70	3.23	2.86	2.55	2.29	2.07	
-1.5	7.86	6.19	5.08	4.28	3.69	3.22	2.85	2.54	2.29	2.07	
-2.0	7.90	6.21	5.09	4.29	3.68	3.22	2.84	2.54	2.29	2.08	
-2.5	7.94	6.24	5.11	4.30	3.70	3.23	2.85	2.55	2.31		
-3.0	8.00	6.29	5.14	4.33	3.72	3.25	2.87	2.58			
-3.5	8.08	6.35	5.19	4.37	3.76	3.28	2.91	2.62			
-4.0	8.17	6.43	5.26	4.43	3.81	3.34	2.97				

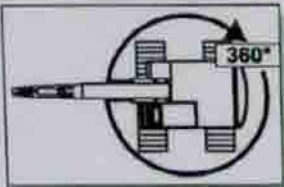

NOTES Radius/height are given in METRES. Loads are given in TONNES, and assume that the load is suspended vertically below the bucket pin. This chart assumes that a 0.80m² (640kg) bucket is fitted. Loads do not exceed 75% of the tipping load, or 87% of hydraulic ability (295.8 bar).
b = loads limited by boom hydraulics, a = loads limited by arm hydraulics

PAGE 2 of 2



Load capacity chart of the excavator



LTA General Specification:

All cranes without manufacturer fitted data loggers operating on LTA sites shall be retrofitted with data loggers approved by the Engineer.

All cranes with manufacturer fitted data loggers shall have the data loggers enabled when operating on LTA sites.



Crane Data loggers (Black Box)



LTA General Specification:

The contractor shall ensure that every LG/LA brought onto site, including that accompanying rental cranes, lorry loaders, excavators, cement buckets, air receivers, skips, welding sets etc. has a valid LG/LA certificate and is clearly marked with its SWL. All LG/LA shall be inspected by an Authorised Examiner once every six months.



Damaged web sling



LTA General Specification:

When not in use, the Contractor shall ensure that all items of the LG/LA are stored in a rack sheltered from the weather and maintained regularly. Should any LG/LA be exposed to a corrosive material e.g. wet concrete, it must be washed and re-greased.



Lifting gears properly stored and maintained in good condition



LIFTING OPERATIONS

LTA General Specification:

There shall be a monthly inspection program to inspect all plant, equipment and tools. Stickers or tags shall be displayed to indicate its approval for usage or "Not for Use".



'Not in Service' tag



Defective equipment were properly tagged 'Out of Service' and stored



LTA General Specification:

The Contractor shall implement an inspection programme to thoroughly check all LG/LA by a lifting supervisor prior to its first use and thereafter on a monthly basis. A monthly colour coding system shall be adopted. Defective LG/LA shall be discarded.

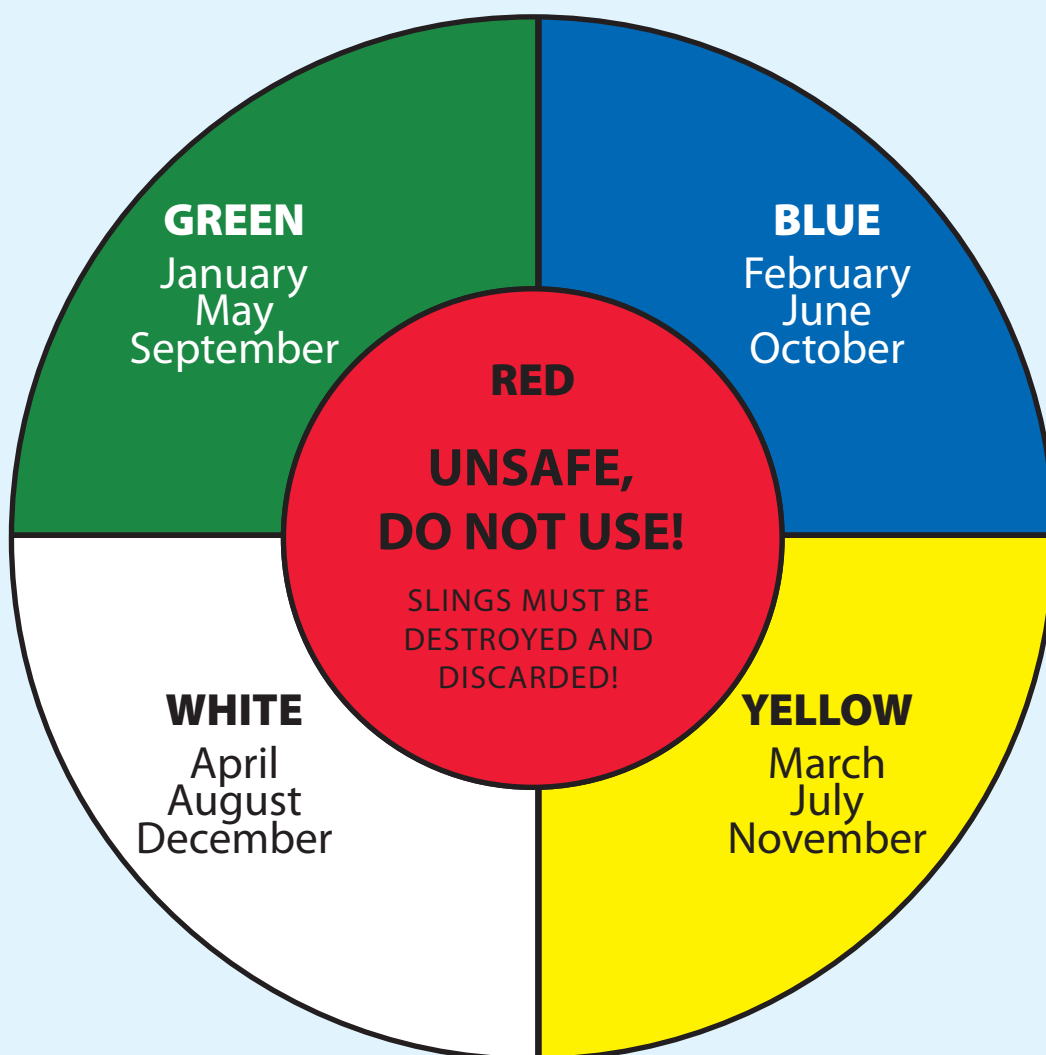

Colour-coding system

This page is intended to be left blank.

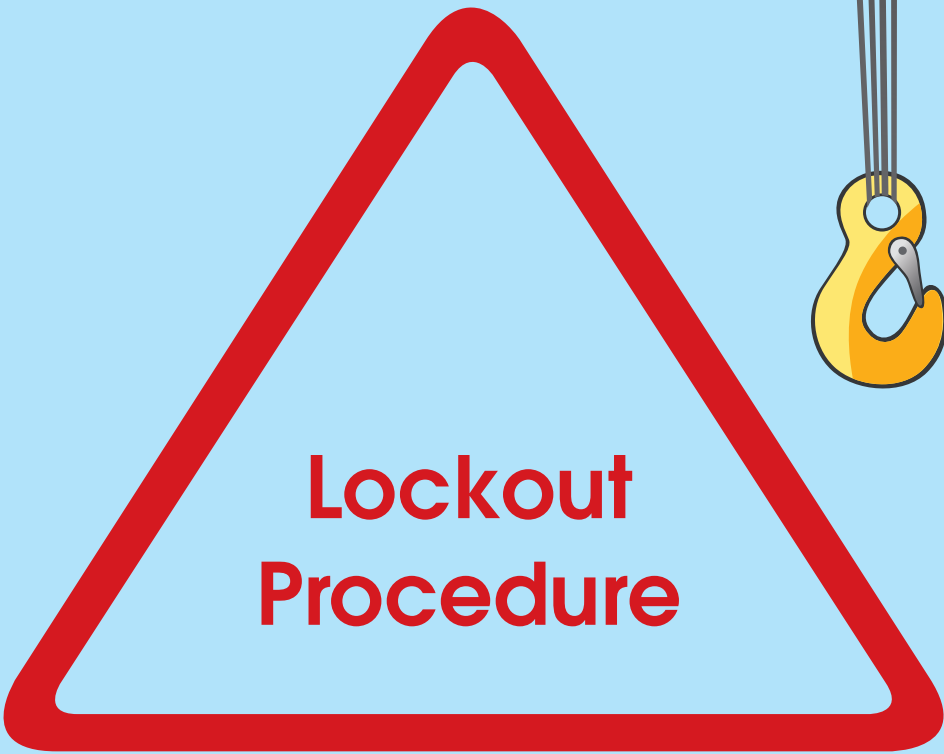
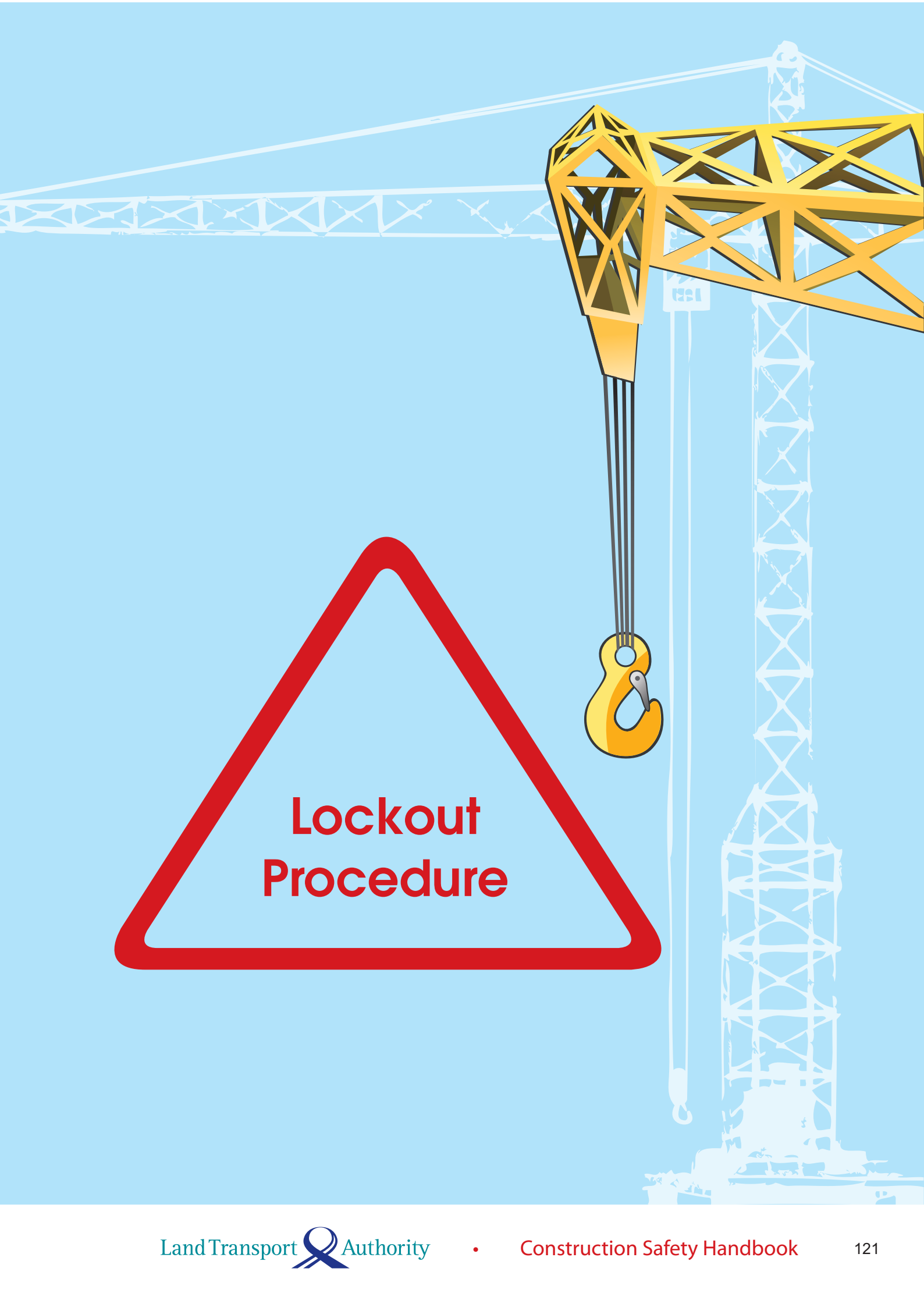

**Lockout
Procedure**



LOCKOUT PROCEDURE

WSH (General Provisions) Reg. 14:

The occupier shall ensure that all practicable measures are taken to protect any person against the risks of electric shock arising from or in connection with the use of any electrical installation or equipment.



Live switchgears locked with warning tags



'Do not Tamper' tag



'Danger' sticker



WSH (General Provisions) Reg. 16:

It shall be the duty of the occupier of a factory to establish and implement lock-out procedures relating to the inspection, cleaning, repair or maintenance of any plant, machinery, equipment or electrical installation in the factory that, if inadvertently activated or energised, is liable to cause bodily injury to any person.

SS 571: 2011:

Locks should be provided by the responsible person/ occupier and should be the only authorised device(s) used for the lockout of energy sources. They should be singularly identified and specifically approved for lockout.

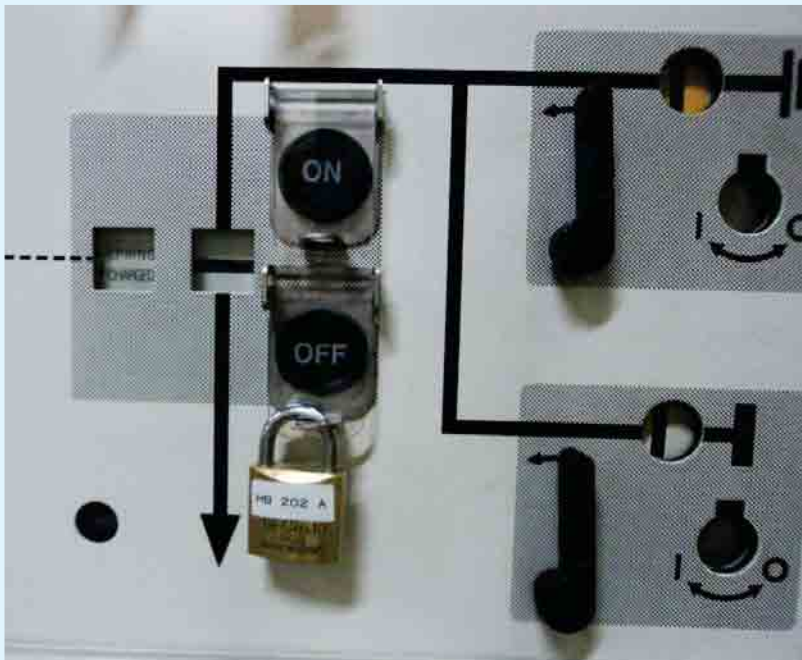

Placement of a lockout device on an energy isolating device



LOCKOUT PROCEDURE

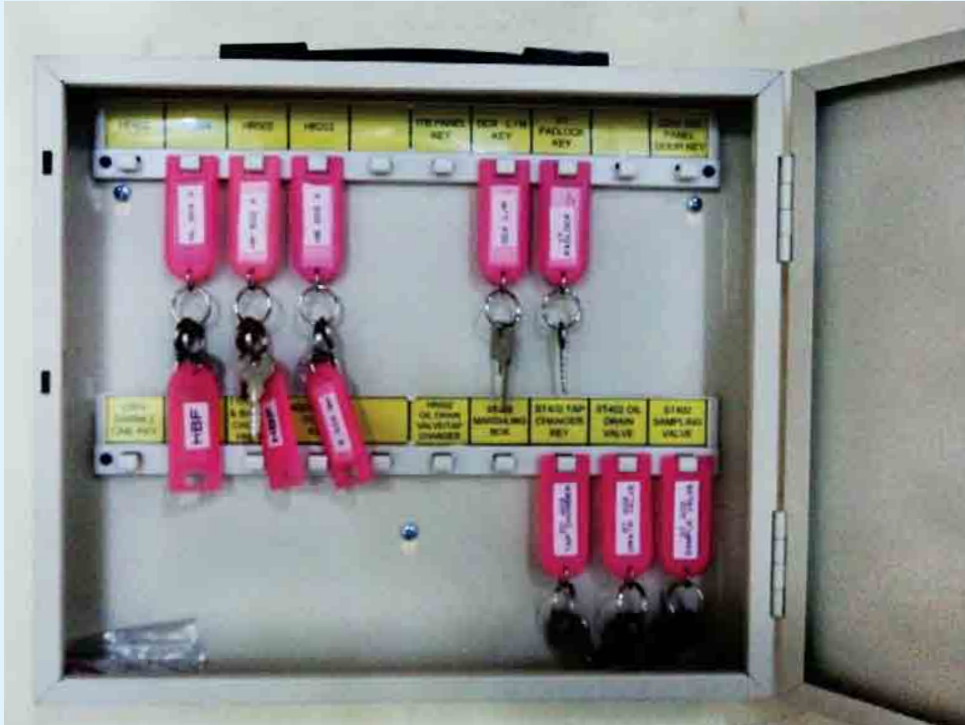

Keys to all work areas, padlocks, tags and signs are kept securely by the Authorised Person



SS 571: 2011:

Procedures shall be established for shift or personnel changes to ensure the continuity of lockout or protection. It shall include a procedure for the orderly transfer of lockout or devices from departing to incoming authorised individuals to minimise exposure to hazards.



Every room is kept with a logbook to record and monitor all activities going on

This page is intended to be left blank.

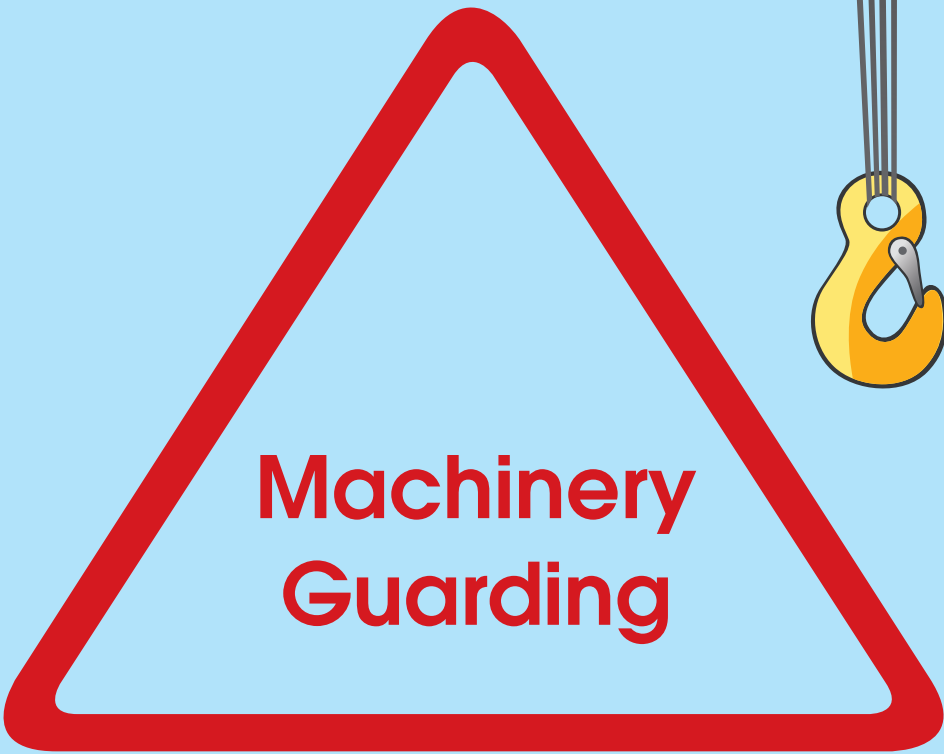
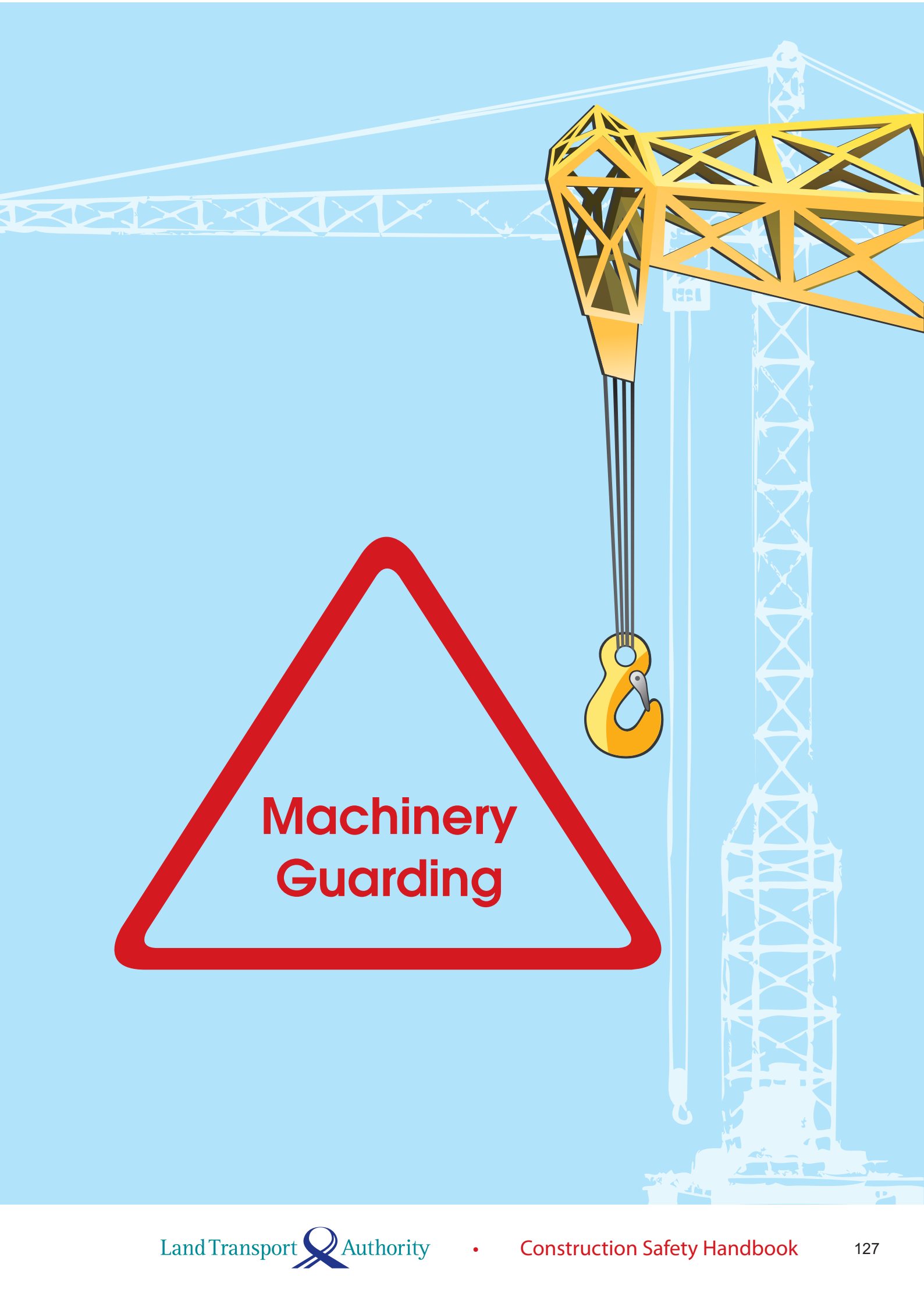

**Machinery
Guarding**



WSH (General Provisions) Reg. 12 (1):

It shall be the duty of the occupier of a factory to ensure that every dangerous part (including any flywheel) of any electric generator, motor, transmission machinery or other machinery is securely fenced.



*The moving part
was fenced*



SS537: Part1: 2008:

The fixed guard should be provided to prevent access to the hazardous parts of the machinery. It should be of robust construction, sufficient to withstand the stresses of the process and environmental conditions.



Fixed guard installed to prevent worker from coming into contact with the machine's hazardous moving part



MACHINERY GUARDING



Fixed guard installed to prevent worker from coming into contact with the machine's hazardous moving part



Installing a makeshift guard for rotating flywheel made from wire mesh





MACHINERY GUARDING



Steel wire should not be used in place of whip arrestor



Use of proper whip arrestor

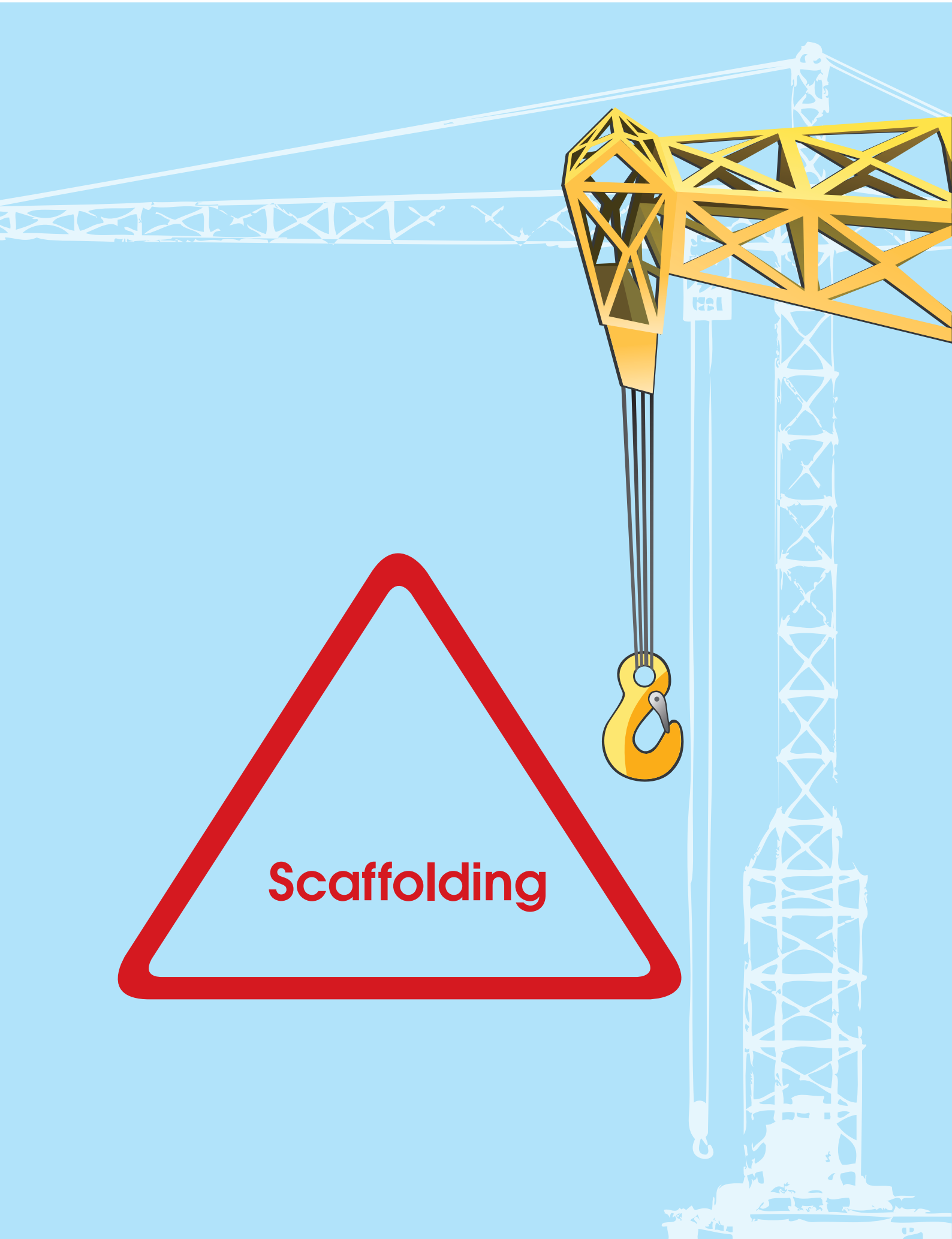



WSH (Scaffolds) Reg. 10:

Every scaffold in a workplace shall be constructed, erected or installed on structures or foundations of adequate strength.

In the case of a scaffold in a workplace exceeding 15 metres in height or being erected on poorly drained soil, base plates shall bear upon sole plates that are :

- a) of strength not less than 670 kgf per square metre; and
- b) of a length suitable to distribute the load.

There shall be no cavity under the sole plate immediately below any standard of a scaffold in a workplace.



Stacked timber pieces as foundation is not acceptable



Absence of base plate



Scaffold erected on a proper foundation



WSH (Scaffolds) Reg. 13:

Ensure that stairs or ladders are provided to enable persons to gain access from one level of any scaffold in a workplace to another level and so far as is reasonably practicable, are installed within the scaffold.



No proper access provided



Proper stairs were provided for access from one level of the scaffold to another level



SCAFFOLDING

WSH (Scaffolds) Reg. 18:

Work platforms in a workplace shall be provided:

- a) at any place of work which does not afford a proper and secure foothold; and
- b) in the case of a building under construction, around the edge of the building at every uppermost permanent floor which is under construction.



Scaffold without proper working platform, access and edge protection



WSH (Scaffolds) Reg. 19:

Signboards stating the maximum permissible weight of tools and materials and the maximum number of persons permissible on each bay shall be prominently displayed at suitable locations on the scaffold in a workplace.



Safe Working Load prominently displayed



WSH (Scaffolds) Reg. 21:

Any board or plank which forms part of a work platform shall project beyond its end support to a distance of not less than 50 millimetres and not more than 4 times the thickness of the board or plank unless it is effectively secured to prevent tipping or uplift.



End of board was effectively secured



WSH (Scaffolds) Reg. 21:

All board, planks or decking used in the construction of work platform shall:

- a) be of uniform thickness;
- b) be capable of supporting a load of 670kgf per square metre with due regard to the spacing of the supports; and
- c) be flushed along their lengths and secured.



Work platform not flushed along their lengths and secured



SCAFFOLDING

WSH (Scaffolds) Reg. 22:

Every side of a work platform or workplace from which a person is liable to fall more than 2 metres shall be provided with toe-boards and 2 or more guards-rails.



Toe-boards and guard-rails were provided along the work platform



WSH (Scaffolds) Reg. 23:

Overlay or screening nets shall be used to envelope any timber or metal scaffold which is erected on the outside of a building.



Screening nets used to envelope scaffold



WSH (Scaffolds) Reg. 26:

Ensure that no scaffold is used unless it has been inspected by a scaffold supervisor:

- a) upon completion of its construction, erection or installation, as the case may be;
- b) thereafter, at intervals of not more than 7 days immediately following the date of the last inspection by the scaffold supervisor; and
- c) after exposure to weather conditions likely to have affected strength or stability or to have displaced any part.



Erected scaffold was inspected by scaffold supervisor



WSH (Scaffolds) Reg. 27:

Scaffold supervisor who carries out the inspection of a scaffold under regulation 26 shall immediately after such inspection, display a notice or label indicating whether the scaffold is safe for use or otherwise.



Scaffold inspected and tagged 'Safe to Use'



SCAFFOLDING

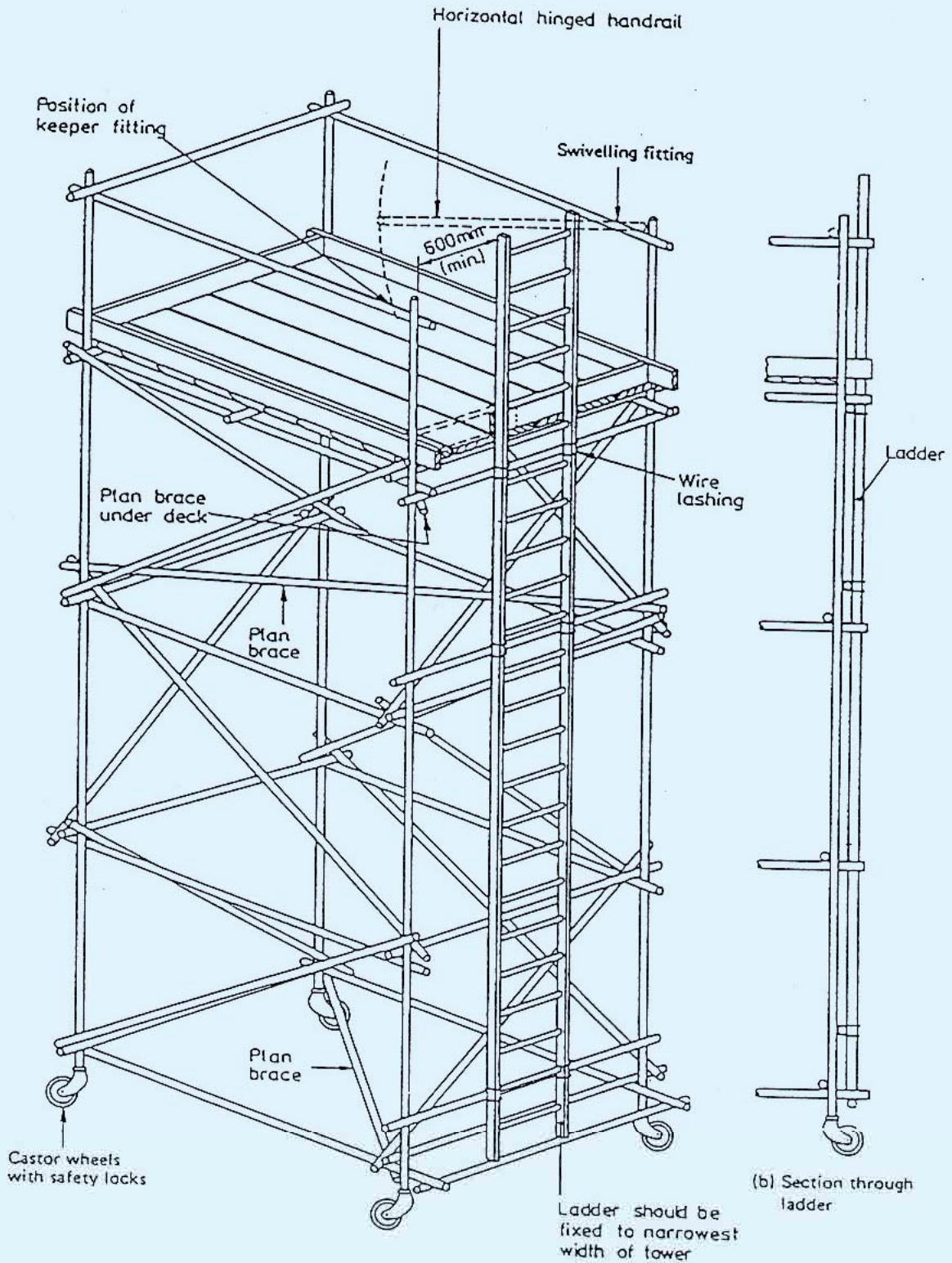

Mobile Tower Scaffold



WSH (Scaffolds) Reg. 29:

No metal scaffold shall be erected or installed in a workplace unless it has been type-tested by a recognised testing body in accordance with a standard or specification acceptable to the Commissioner and complies with such conditions as the Commissioner may think fit to impose.

Test Report No. 54S074245/TKC
Dated: 20 July 2007

Note: This report is issued subject to TDV SDD PSB Corporation's "Terms and Conditions Governing Technical Services". The terms and conditions governing the issue of this report are set out as attached within this report.

DEFLECTION AND BENDING STRENGTH TEST OF METALTREAD BOARD

Tested for : NBN Scaffolding Pte Ltd
9 Defu Lane 4,
Attn : Mr. Tan Boon Leong

Test standard : SS 280 : 1984 Specification for frame scaffoldings.
Clause 5.2 Load test on components of frame scaffolding system

Sample description : Five pieces of galvanised metal tread board (see photo) were received on 21 June 2007.

TEST RESULTS:

Sample reference	1	3	5	SS 280 : 1984 Clause 4.1 & 5.2 Requirements	
Width of tread (mm)				-	
Nominal thickness of tread board (mm)				1.2 ± 0.1	
Span (mm)	1829			-	
Length (mm)	1829			-	
Deflection test (mm)	2.61	4.89	3.88	4.74	Deflection shall not exceed 10mm at a load of 0.941kN
Maximum bending (kN)	3.32	3.12	3.34	3.53	Min. 2.352
Minimum bending (kN)		3.30			Min. 2.592

Note: The span is the centre horizontal distance between the members of scaffold frame when used with 1829mm length (pin-hole to pin-hole) cross bracing.

TEST REPORT

Your Ref: - Date: 27 March 2006

Our Ref: 54S061499/1/TKC Page: 1 of 2

OID: 6885 1429 Fax: 6779 3903

TENSILE STRENGTH TEST OF SCAFFOLD PIPE

Tested for : NBN Scaffolding Pte. Ltd.
9 Defu Lane 4,
Singapore 539413
Attn : Mr. Tan Boon Leong

Test standard : JIS Z 2201 : 1980 "Test pieces for tensile test of metallic materials"

Sample description : Two pieces of Ø48.6mm (outer diameter) x 3mm (t) scaffolding pipe were received.

Date submitted : 20 March 2006

TEST RESULTS:

Sample reference	Sample description	JIS G3444 : 1988 Grade
	Ø48.6mm (Outer diameter) x 3mm (t)	STK 500 Table 3-2 Requirements
Measured width (mm)	19.06	-
Measured thickness (mm)	2.31	-
Deflection (mm)	44.03	-
Yield strength (N/mm ²)	429	Min. 355
Tensile strength (N/mm ²)	528	Min. 500
Elongation at 50mm GL (%)	24	Min. 15
Position of fracture	Broke between gauge marks	-

The test results comply with JIS G3444 : 1988 (Grade STK 500) Table 3-2 requirements.



Scaffold Test Certificate

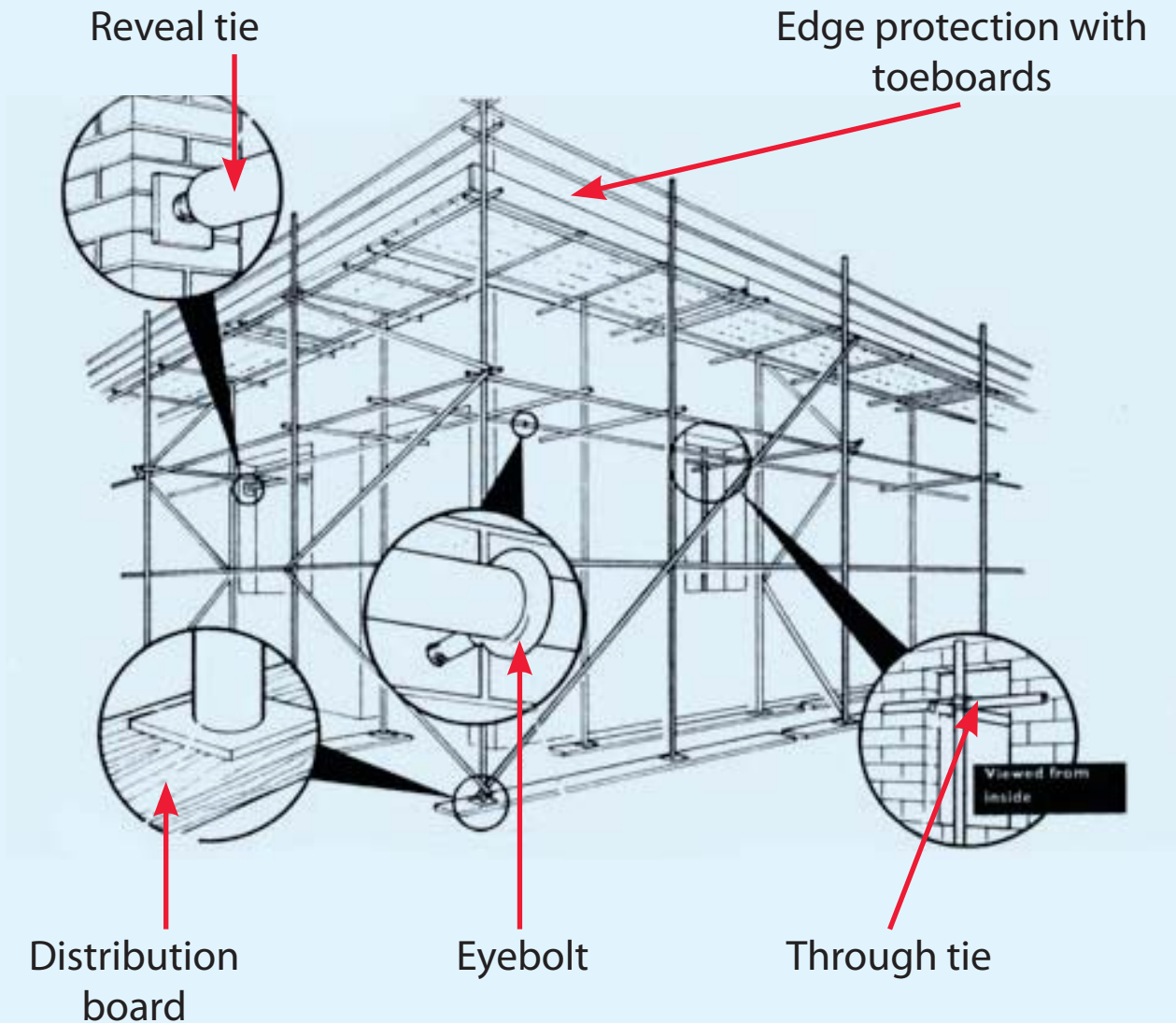

WSH (Scaffolds) Reg. 31:

Every alternate lift and every uppermost lift of an independent tied metal scaffold in a workplace shall be effectively tied to the building or structure by means of ties.

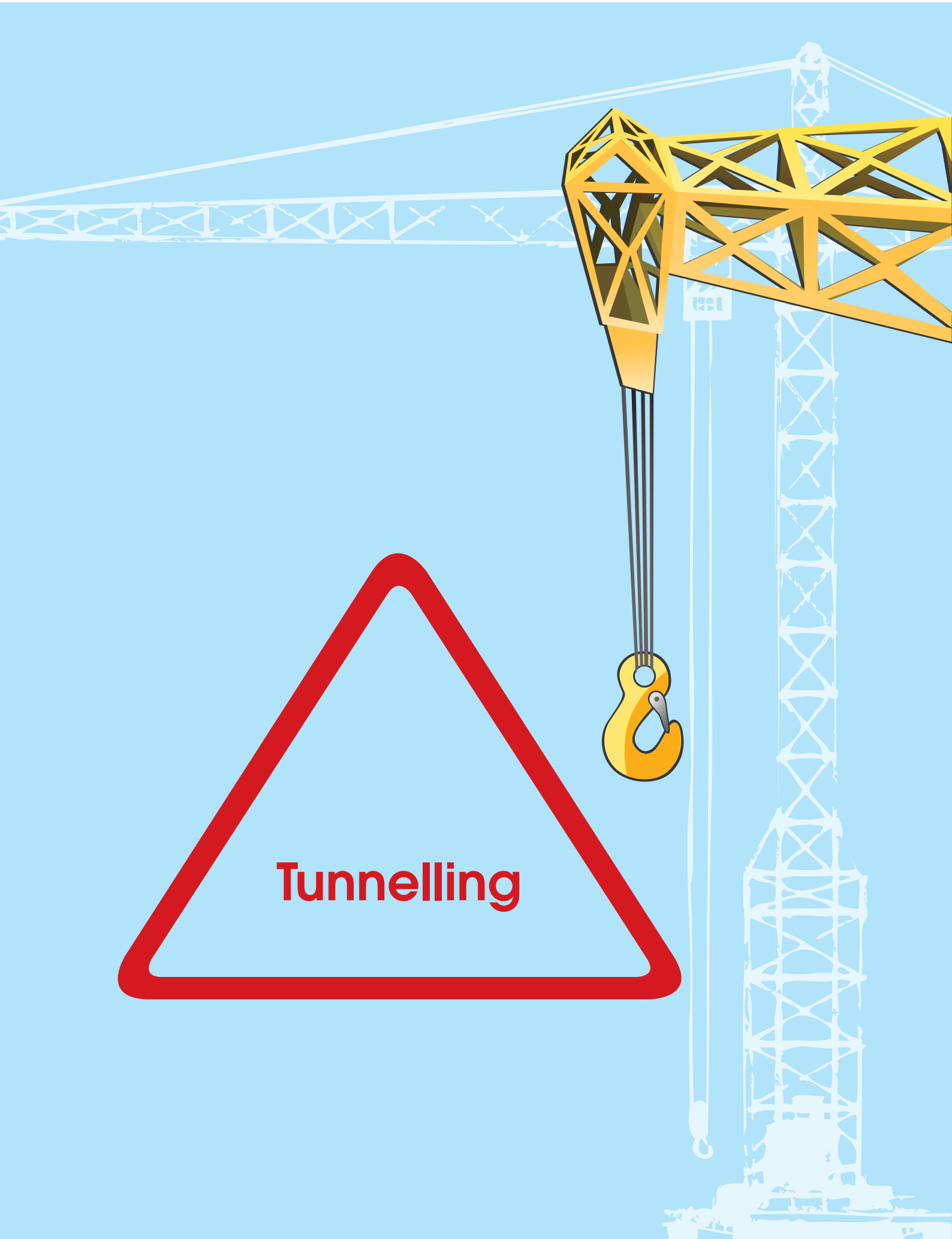



WSH (Construction) Reg. 82:

In a worksite where tunnelling works are carried out:

- a) all work area in a free air tunnel shall be provided with appropriate ventilation system to ensure adequate supply of air;
- b) all reasonably practicable measures shall be taken to ensure that the air in the tunnel where a person has to work is free from flammable gases and vapours and contains :
 - (i) at least 19.5% oxygen by volume; and
 - (ii) not more than 23.5% oxygen by volume; and
- c) air that has passed through any underground oil or fuel storage shall not be used for ventilation in the tunnel.



Gas check



WSH (Construction) Reg. 83:

In a worksite where tunnelling works are carried out:

- a) all areas in the tunnel shall be adequately illuminated; and
- b) emergency generators are provided to ensure adequate illumination of the tunnels and work areas in the event of a failure in the power supply.



Well illuminated tunnel



WSH (Construction) Reg. 84:

In a worksite where tunnelling works are carried out:

- a) proper control of ingress and egress of persons to and from any tunnel under construction in the worksite shall be exercised;
- b) a chart listing the names of persons working in the tunnel and their location of work shall be displayed at the main entrance to the tunnel and be regularly updated; and
- c) notices to warn persons against unauthorised entry shall be displayed at all points of entry to the tunnel.



Tally board placed near excavation opening



WSH (Construction) Reg. 85:

No diesel engine shall be used in a tunnel unless it is so constructed that no air enters the engine without first being cleaned, and no fumes or sparks shall be emitted by the engine:

- a) oil, grease or fuel stored in the tunnel shall be kept in tightly sealed containers in fire resistant areas at safe distances from explosives, magazines, electrical installations and away from bottom of shafts;
- b) gasoline or liquefied petroleum gases or other flammable substances shall not be used in the tunnel without the approval of the project manager of the worksite.



Tunnel kept free of combustible material



Provision of fire point in tunnel



WSH (Construction) Reg. 86:

- a) Effective and reliable means of communication, such as telephone network, shall be provided at intervals of 100 metres along the tunnel in the worksite, including outside the portal or at the top of the shaft, and maintained at all times.
- b) Any code of audio and visual signals used shall be conspicuously displayed near the entrances to the worksite and such other locations as may be necessary to bring it to the attention of all persons concerned.



Emergency telephone provided in tunnel



WSH (Construction) Reg. 87:

Appropriate control measures shall be implemented to prevent any unauthorised person from tampering with fittings, valves or other controls regulating air supply, lighting, electricity or any monitoring system used in connection with any work in the tunnels in the worksite.



Locked distribution box



WSH (Construction) Reg. 95:

No oxy-acetylene shall be used in the compressed air environment in the worksite.

WSH (Construction) Reg. 104:

Where work in a compressed air environment in a worksite is carried out:

- a) no person shall consume alcohol or smoke while at work in the compressed air environment;
- b) no person shall carry cigarettes, cigarette lighters, matches or other sources of ignition into the compressed air environment; and
- c) no person who has consumed alcohol shall be allowed to undergo compression in any lock in the worksite other than in a medical lock.



'No smoking' sign at entrance into excavation

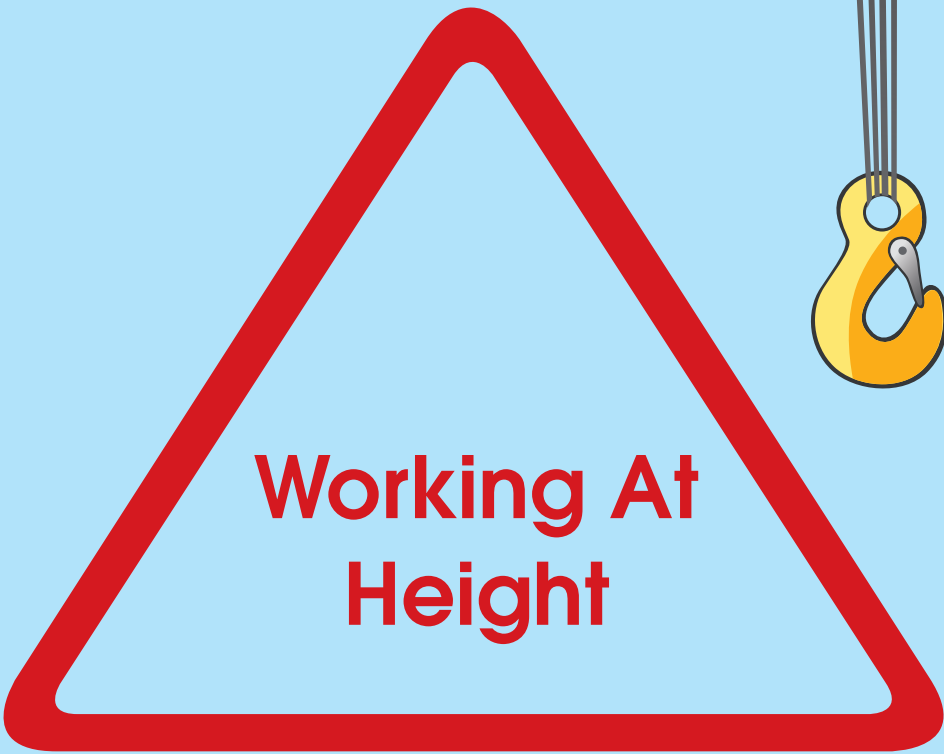
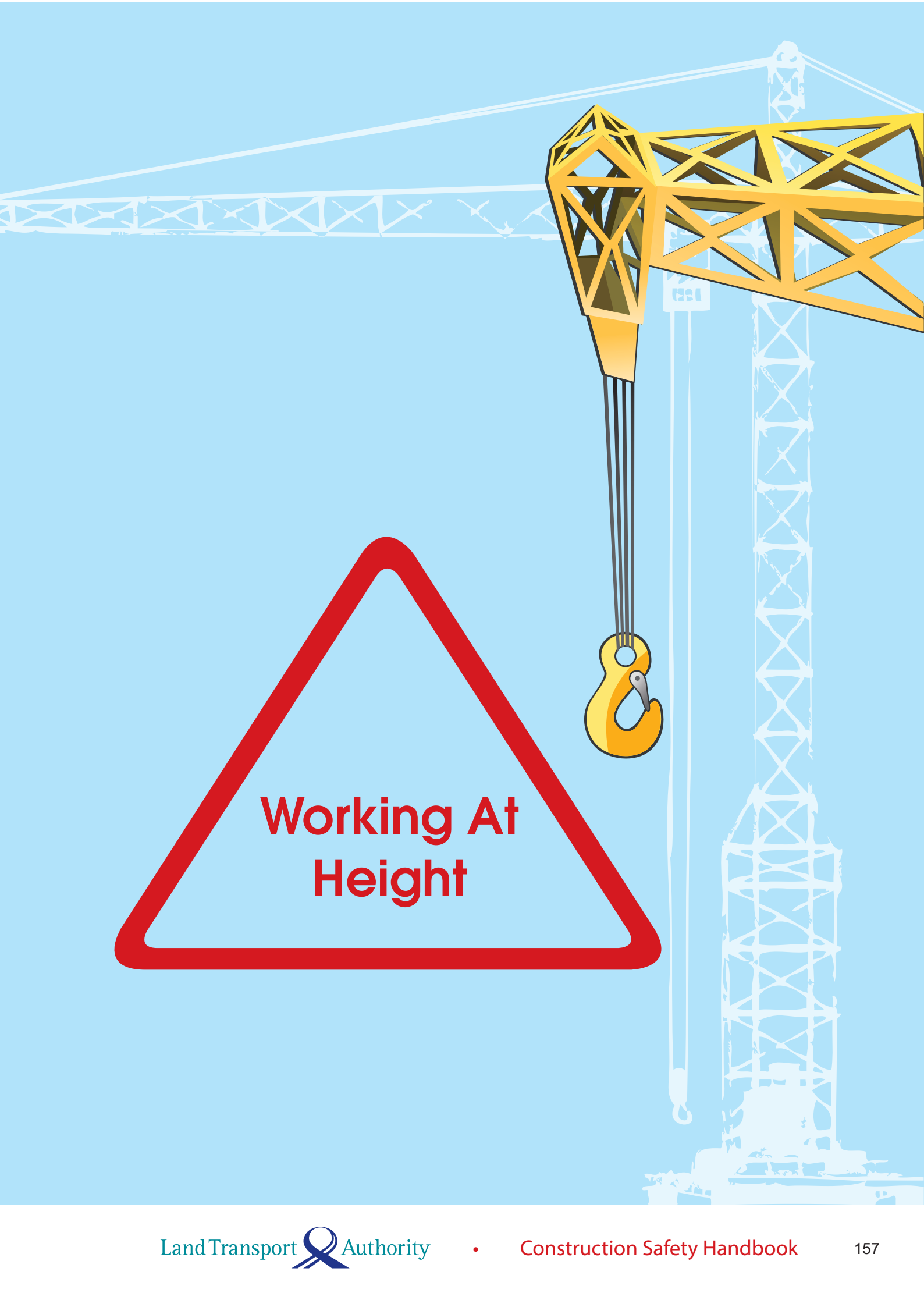

**Working At
Height**



WSH (General Provisions) Reg. 23:

Any person who has to work at a place from which he would be liable to fall:

- a) a distance of more than 2 metres; or
- b) into a substance which is likely to cause drowning or asphyxiation

shall be provided with a secure foothold and handhold at a place so far as is reasonably practicable for ensuring his safety.



Provision of secure foothold and handhold





WSH (General Provisions) Reg. 23:

Where it is not reasonably practicable to provide a secure foothold or handhold, other suitable means such as safety harness or safety belt shall be provided for ensuring the safety of every person working at such places.



Safety harness should be provided



WSH (General Provisions) Reg. 23:

All openings in floors shall be securely covered or fenced unless the nature of the work renders such covering or fencing impracticable.



Opening in floor is not covered to prevent fall



Covered opening



A13 mesh, fixed to the top steel and cast into the slab



Provision of standard method of railings, toeboards and netting. Height of railings to be at least 1.1m high

This page is intended to be left blank.

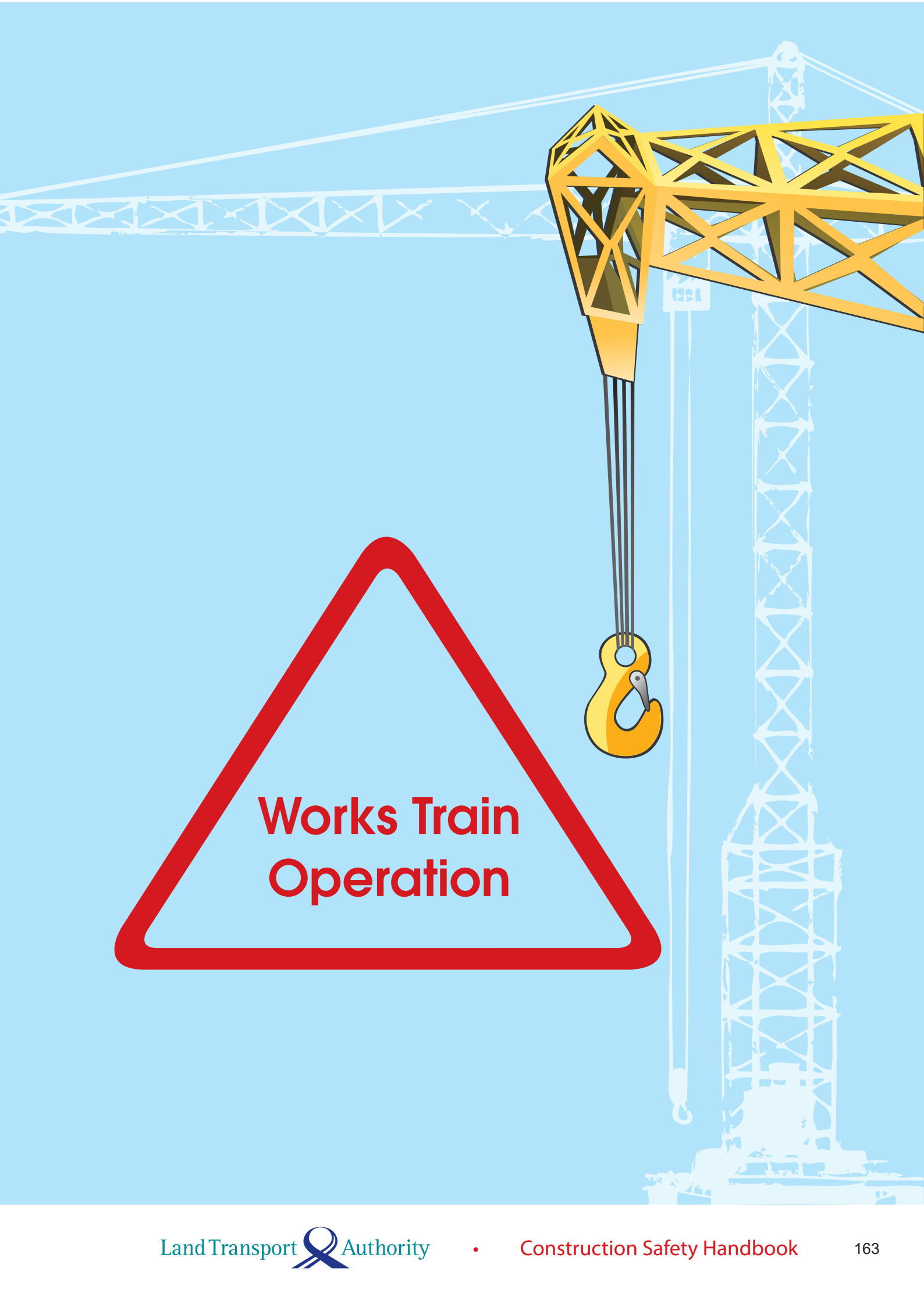

**Works Train
Operation**



WORKS TRAIN OPERATION



Use of wheel scotch on stationary trains to prevent runaway train through unintentional movement



Target disc displayed in front and back of train used in conjunction with wheel scotch for stationary train



Point Numbers marked clearly to avoid confusion



Point secured with G Clamp & Point Scotch for a Safe Shunting movement



WORKS TRAIN OPERATION



Buffer installed at the end of track to prevent overrun of train



Warning signage posted on Works Train



Ground Shunter using coloured flags to direct an approaching train



Sector Limit Board with flashing light is used by the Possession Master who has full control of a sector for demarcation purposes



WORKS TRAIN OPERATION



Service Vehicle Load Gauge installed to ensure loads or materials on the train will not protrude beyond allowable limits



Materials are secured onto the wagon before moving off to avoid derailment caused by objects on the rails



Demarcation of Defined Areas



Warning signage's posted for Defined Areas



WORKS TRAIN OPERATION



Lifting Operation at the Shaft must be authorised by Lifting Engineer



Providing proper access



Short Circuit Device (SCD) applied onto energised test track to prevent electrocution of workers

Prior to the application of SCD, the Works Train Staff shall use a voltage tester to check that the 3rd Rail is 'NOT LIVE'



Uncommissioned signals and indicators are concealed to avoid confusion



WORKS TRAIN OPERATION



Track trolley with scaffold materials left unattended within the Defined Area and no sight of any working group within the vicinity



Access gate into the Defined Area unlocked and unattended by the Possession Master

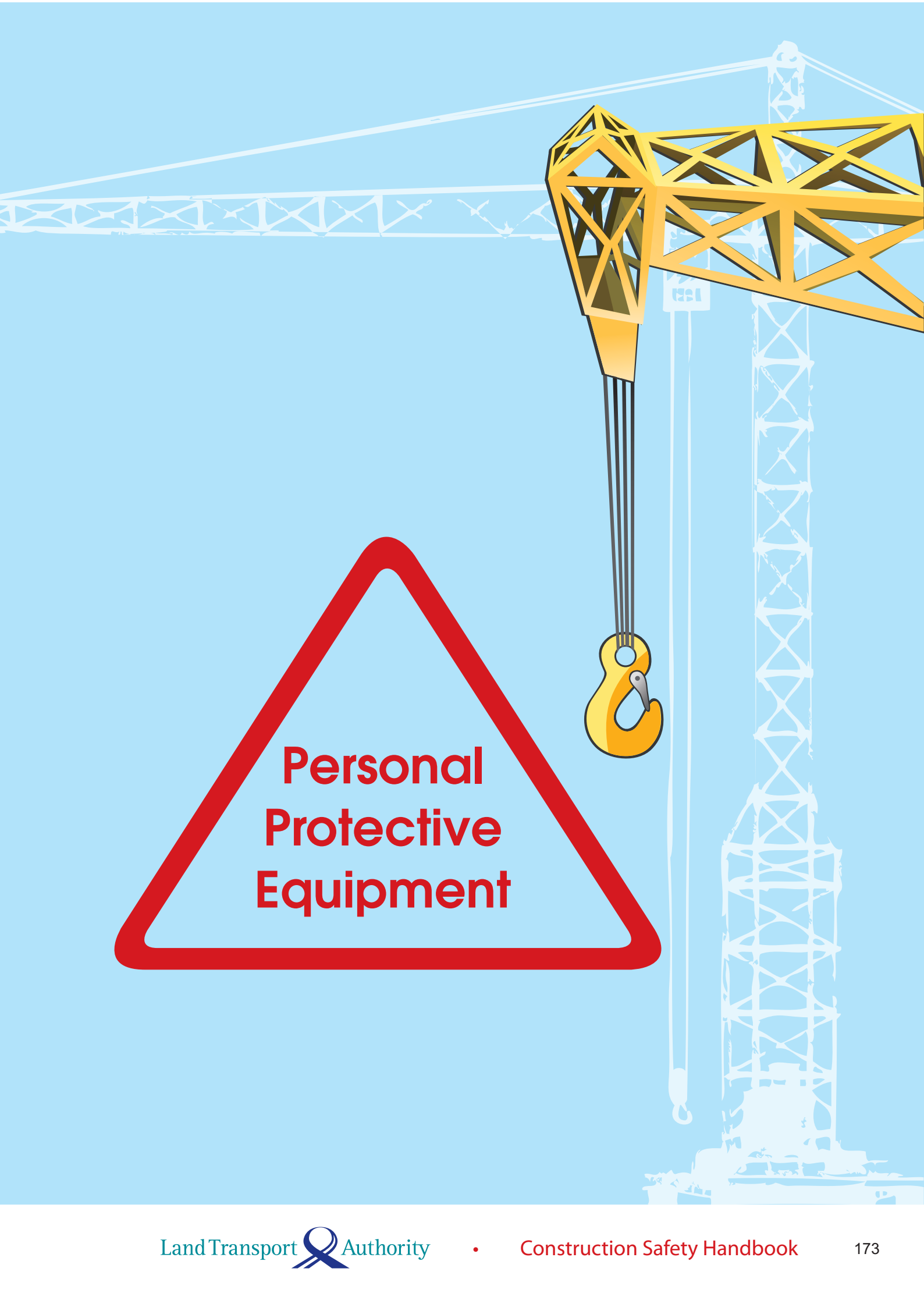

**Personal
Protective
Equipment**



WSH (Construction) Reg. 33:

It shall be the duty of the employer of any person who carries out any work in a worksite or the principal under whose direction any person carries out any work in a worksite to provide and maintain the appropriate personal protective equipment to the person.

The protection is as follows:

- a) eye protection
- b) fall protection
- c) foot protection
- d) hand protection
- e) head protection
- f) hearing protection; and
- g) respiratory protection.



Signage to remind site personnel to put on PPE



LTA General Specification:

The contractor shall provide, maintain and enforce the usage of PPE for all the personnel on site at all times. The following PPE shall be compulsory in site:

- a) safety helmets with chin strap conforming to SS98 showing the contract number;
- b) safety footwear with steel toe cap and steel sole plate conforming to SS513;
- c) high-visibility vest/clothing conforming to BS EN 471;
- d) safety belts shall be provided for restraining falls or safety harness for fall protection. Safety belts and harness shall comply with SS528 series (Personal fall-arrest systems), SS541 (Restraint belts) and SS570 (Personal protective equipment for protection against falls from a height – Single point anchor devices and flexible horizontal lifeline systems);
- e) respirators / dust masks of the appropriate standard shall be provided for activities generating dust or fume.



Head Protection



Safety helmet

Eye Protection



Safety goggles

Visibility Protection



High-visibility vest



Respiratory Protection



Dust Mask:

It is relatively comfortable but offers minimal protection due to inferior sealing qualities.



Half-face respirators:

Relatively light-weight as well as offer good protection.



Full-face respirators:

Heavier than half-mask and less comfortable but it offers more protection through its better sealing qualities.

It also protects the eyes and face from irritating vapours.



Hearing Protection



Ear Plugs:

Ear plugs provide better noise protection if properly fitted into the ear canal. Generally, NRR (Noise Reduction Rating) for ear plug is higher than NRR for ear muff.



Ear Muffs:

Ear muffs provide lower level of noise protection as compared to ear plugs. However, the wearer is most likely to get the rated protection due to its ease of providing proper fit.



Hand Protection



*Metal mesh gloves:
Protect hands from
accidental cuts and
scratches from working
with cutting tools.*



*Latex-coated Kevlar
gloves:
Improve grip and protect
hands from cut and
abrasion.*



*Leather gloves:
Guard against injuries
from sparks or scraping
against rough surfaces.*



*Chemical resistant gloves:
Protect hands from
corrosives, oils, and
solvents.*

Note:

When selecting chemical resistance gloves, be sure to consult the manufacturers' recommendations.



Chart of cut resistance level

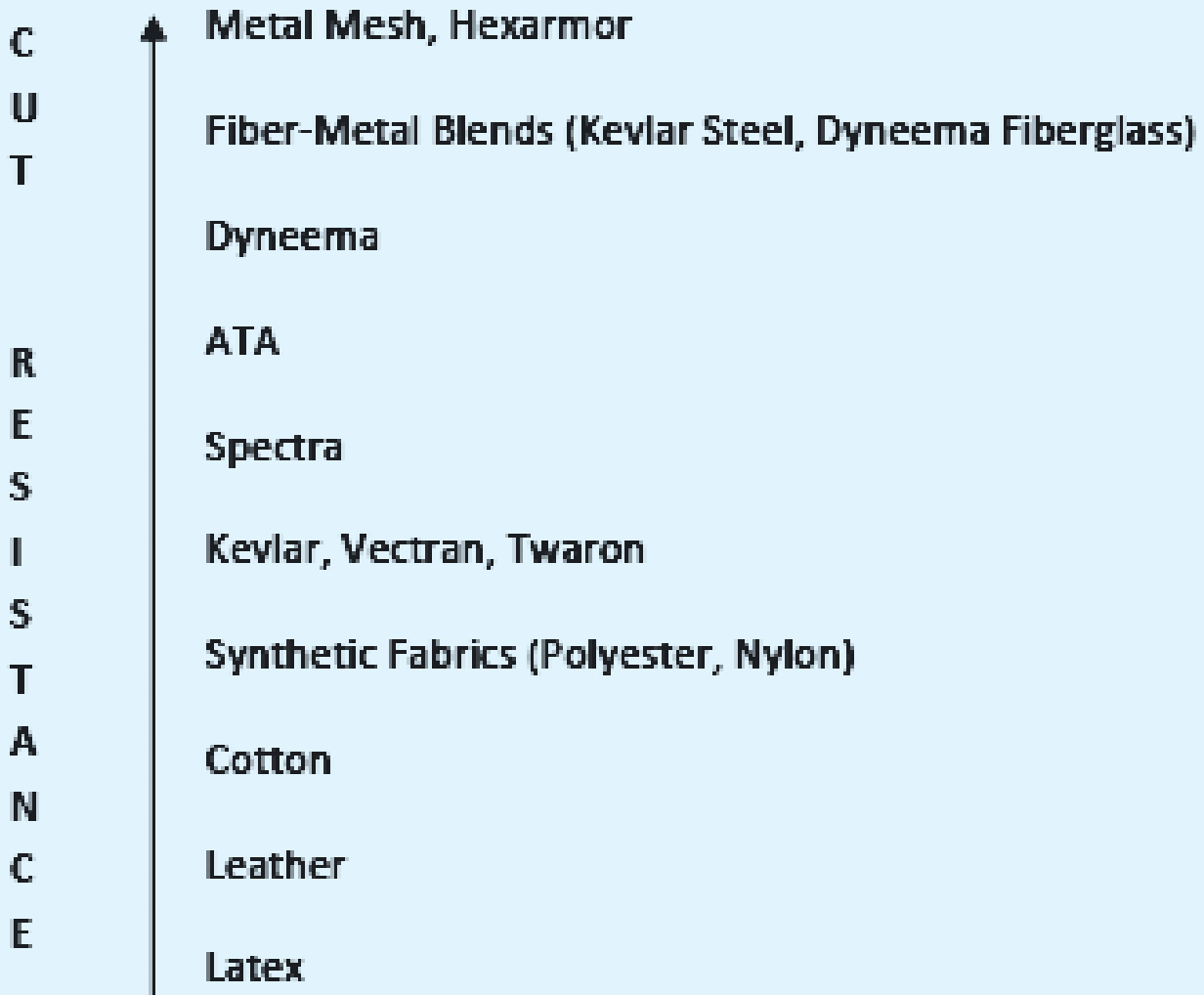

Sources:
Making Sense of Cut Resistance by National Safety, Inc. (USA)
www.nationalsafetyinc.com

Note:

Please refer to manufacturers' recommendations and the above chart when selecting a pair of cut resistant gloves.



Foot Protection



Safety boots



High heeled waterproof safety boots



Fall Protection

Fall Arrest



Safety harness – Stop the fall (keep the wearer from hitting the ground after a fall from the edge).

Fall Restraint



Safety belt – Restraint wearer from falling (keep the wearer away from the edge).



- CP 79: 1999 : Code of Practice for Safety Management System for Construction Worksites
- CP 88: Part 1: 2001: Code of Practice for Temporary Electrical Installations (Construction and Building Sites)
- LTA General Specification Appendix A
- Workplace Safety and Health Act
- WSH (Confined Space) Regulations 2009
- WSH (Construction) Regulations 2007
- WSH (First Aid) (Amendment) Regulations 2011
- WSH (General Provisions) (Amendment) Regulations 2011
- WSH (Operation of Cranes) Regulations 2011
- WSH (Scaffolds) Regulations 2011
- SS 510: 2005 : Safety in welding and cutting (and other operations involving the use of heat)
- SS 536: 2008: Code of Practice for The Safe Use of Mobile Cranes
- SS 537: Part 1: 2008 : Safe Use of Machinery
- SS 568: 2011 : Code of Practice for Confined Spaces
- SS 571: 2011 : Code of Practice for Energy Lockout and Tagout

NOTES